

# MINI-M4™

development board for KINETIS

The whole KINETIS development board fitted in DIP40 form factor, containing the MK64FN1M0VDC12 microcontroller.

# TO OUR VALUED CUSTOMERS

I want to express my thanks to you for being interested in our products and for having confidence in Mikroelektronika.

The primary aim of our company is to design and produce high quality electronic products and to constantly improve the performance thereof in order to better suit your needs.

A white, handwritten signature in cursive script, appearing to read 'N. Matic', set against a dark green background.

Nebojsa Matic  
General Manager

# Table of Contents

---

Introduction to MINI-M4 for KINETIS	4
Key features	4
System Specification	5
1. Programming with mikroBootloader	6
step 1 - Connecting MINI-M4 for KINETIS	6
step 2 - Browsing for .HEX file	7
step 3 - Selecting .HEX file	7
step 4 - Uploading .HEX file	8
step 5 - Finish upload	9
2. Schematic	10
3. Pinout	11
4. Dimensions	12

---

# Introduction to MINI-M4 for KINETIS

Miniature and powerful development tool designed to work as stand alone device or as MCU card in DIP40 socket. MINI-M4 for Kinetis is an ARM® Cortex™-M4 development board containing MK64FN1M0VDC12 microcontroller.

The board is pre programmed with USB HID bootloader so it is not necessary to have external programmer. If there is need for external programmers (mikroProg™ or ST-LINK V2) attach it to MINI-M4 for STM32 via pads marked with TK

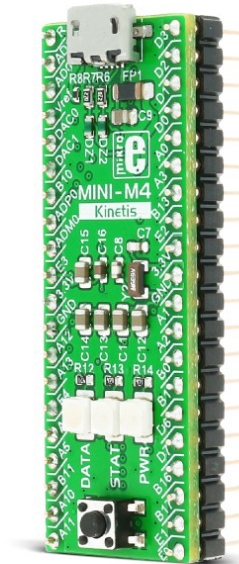

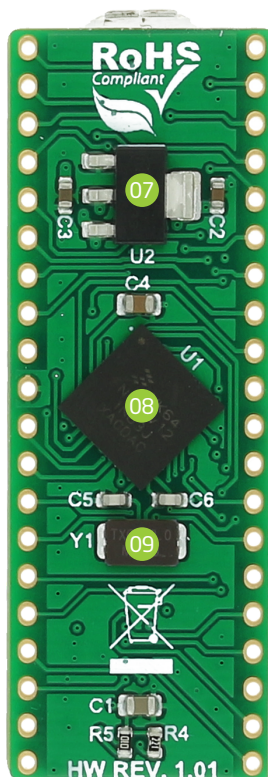
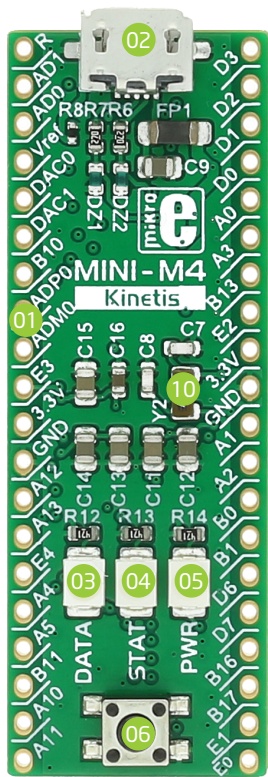

## Key features

- 01 Connection Pads
- 02 USB MICRO connector
- 03 DATA LED
- 04 STAT LED
- 05 POWER supply LED
- 06 Reset button
- 07 Power supply regulator
- 08 Microcontroller MK64FN1M0VDC12
- 09 12 MHz Crystal oscillator
- 10 32.768kHz Crystal oscillator

# 1. Programming with mikroBootloader

You can program the microcontroller with bootloader which is pre programmed into the device by default. To transfer .hex file from a PC to MCU you need bootloader software (**mikroBootloader USB HID**) which can be downloaded from:



<https://download.mikroe.com/examples/starter-boards/mini/kinetis/mini-m4-kinetis-mikrobootloader-v100.zip>

After software is downloaded unzip it to desired location and start mikroBootloader USB HID software.

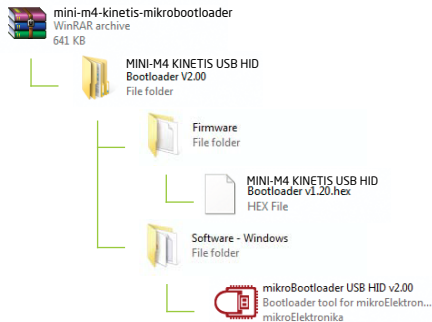

## step 1 - Connecting MINI-M4



Figure 1-1: USB HID mikroBootloader window

**01** To start, connect the USB cable, or if already connected press the **Reset** button on your MINI-M4 board. Click the **“Connect”** button within 5s to enter the bootloader mode, otherwise existing microcontroller program will execute.

## step 2 - Browsing for .HEX file



Figure 1-2: Browse for HEX

- 01 Click the **"Browse for HEX"** button and from a pop-up window (**Figure 1-3**) choose the .HEX file which will be uploaded to MCU memory.

## step 3 - Selecting .HEX file

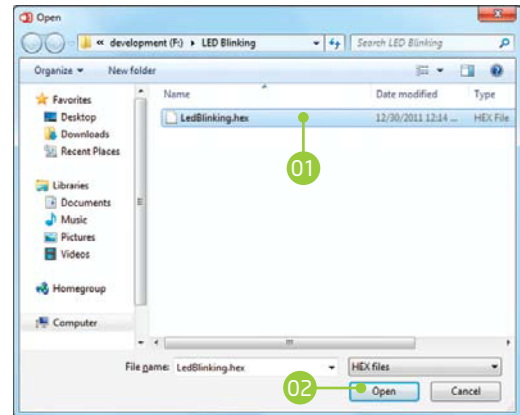

Figure 1-3: Selecting HEX

- 01 Select .HEX file using open dialog window.
- 02 Click the **"Open"** button.

## step 4 - Uploading .HEX file



Figure 1-4: Begin uploading

01 To start .HEX file bootloading click the "Begin uploading" button.



Figure 1-5: Progress bar

01 You can monitor .HEX file uploading via progress bar



## step 5 - Finish upload

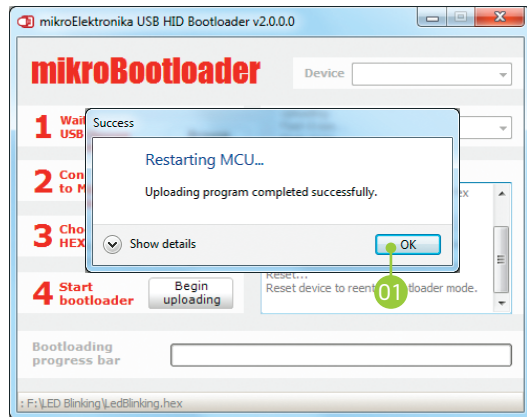

Figure 1-6: Restarting MCU

- 01 Click the **"OK"** button after uploading is finished and wait for 5 seconds. Board will automatically reset and your new program will execute.



Figure 1-7: mikroBootloader ready for next job



# 3. Pinout

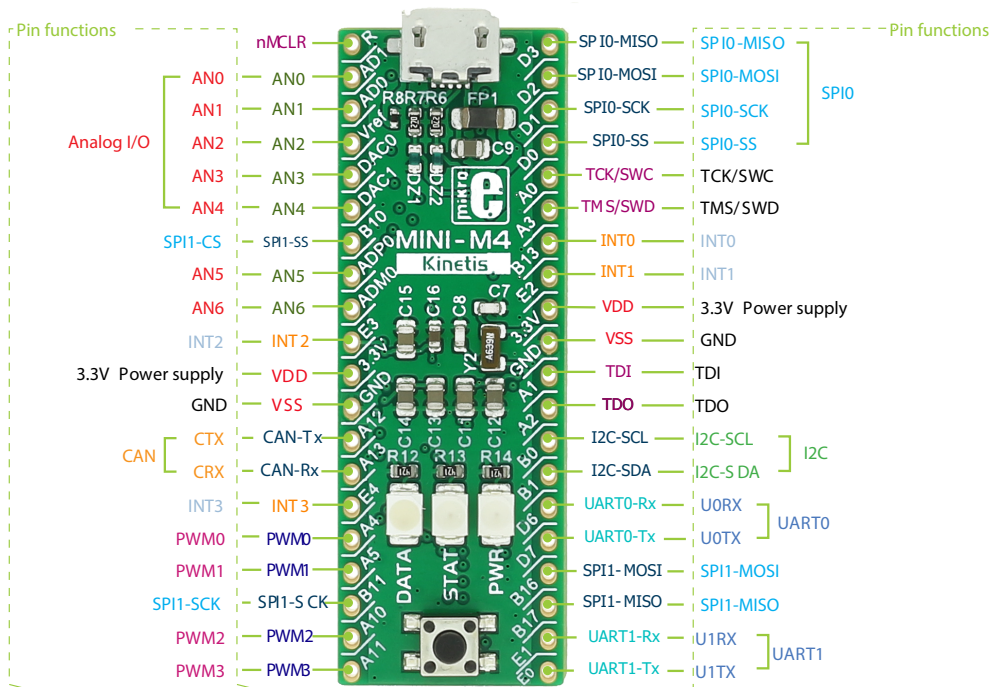

■ Analog Lines  
 ■ Interrupt Lines  
 ■ SPI Lines  
 ■ I2C Lines  
 ■ UART lines  
 ■ CAN lines  
 ■ PWM lines

## 4. Dimensions

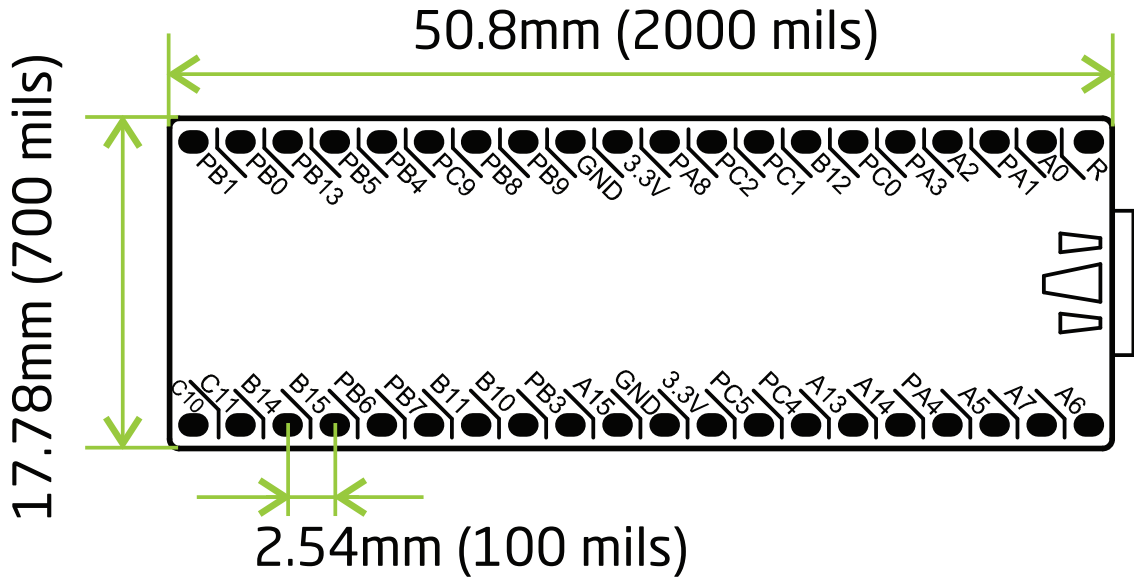

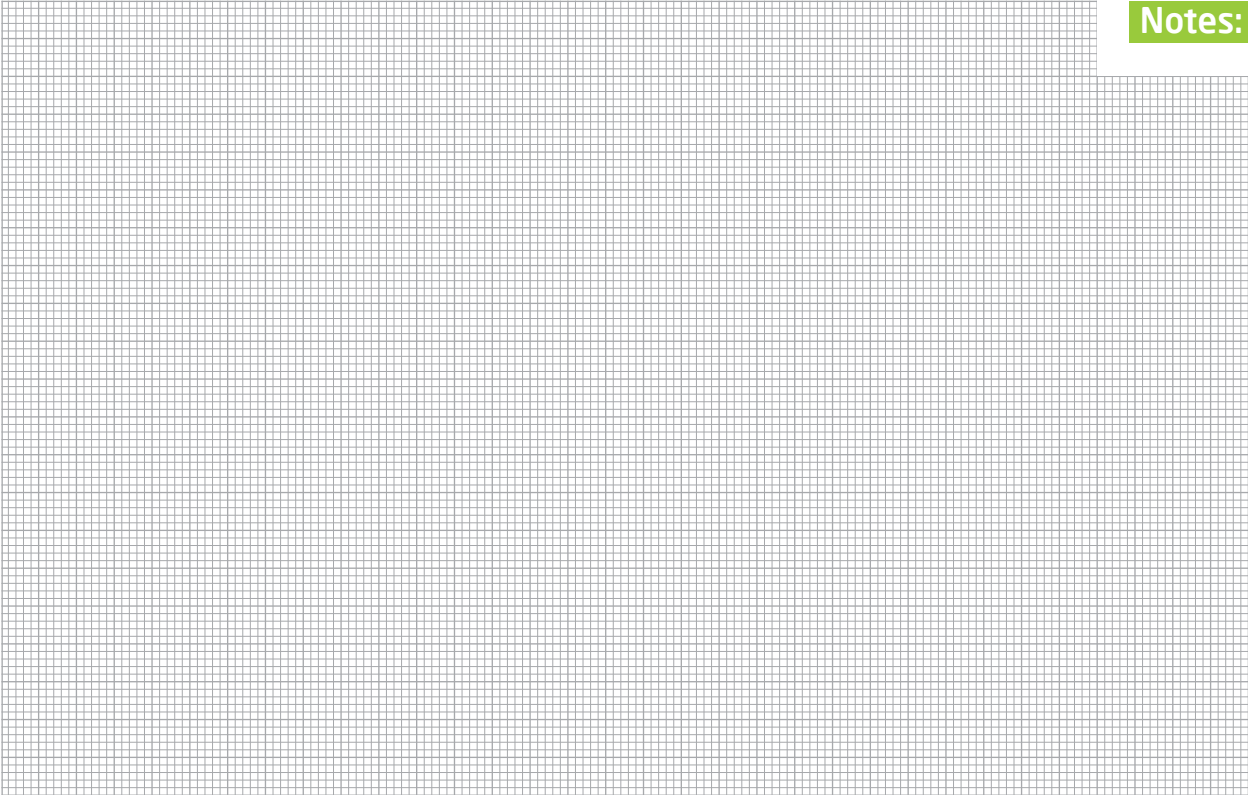

Notes:

## DISCLAIMER

All the products owned by MikroElektronika are protected by copyright law and international copyright treaty. Therefore, this manual is to be treated as any other copyright material. No part of this manual, including product and software described herein, may be reproduced, stored in a retrieval system, translated or transmitted in any form or by any means, without the prior written permission of MikroElektronika. The manual PDF edition can be printed for private or local use, but not for distribution. Any modification of this manual is prohibited.

MikroElektronika provides this manual 'as is' without warranty of any kind, either expressed or implied, including, but not limited to, the implied warranties or conditions of merchantability or fitness for a particular purpose.

MikroElektronika shall assume no responsibility or liability for any errors, omissions and inaccuracies that may appear in this manual. In no event shall MikroElektronika, its directors, officers, employees or distributors be liable for any indirect, specific, incidental or consequential damages (including damages for loss of business profits and business information, business interruption or any other pecuniary loss) arising out of the use of this manual or product, even if MikroElektronika has been advised of the possibility of such damages. MikroElektronika reserves the right to change information contained in this manual at any time without prior notice, if necessary.

## HIGH RISK ACTIVITIES

The products of MikroElektronika are not fault - tolerant nor designed, manufactured or intended for use or resale as on - line control equipment in hazardous environments requiring fail - safe performance, such as in the operation of nuclear facilities, aircraft navigation or communication systems, air traffic control, direct life support machines or weapons systems in which the failure of Software could lead directly to death, personal injury or severe physical or environmental damage ('High Risk Activities'). MikroElektronika and its suppliers specifically disclaim any expressed or implied warranty of fitness for High Risk Activities.

## TRADEMARKS

The MikroElektronika name and logo, the MikroElektronika logo, mikroC™, mikroBasic™, mikroPascal™, MINI™, EasyMX PRO™, mikroBUS™, Click Boards™, mikroProg™, and mikromedia™ are trademarks of MikroElektronika. All other trademarks mentioned herein are property of their respective companies.

All other product and corporate names appearing in this manual may or may not be registered trademarks or copyrights of their respective companies, and are only used for identification or explanation and to the owners' benefit, with no intent to infringe.



If you want to learn more about our products, please visit our website at [www.mikroe.com](http://www.mikroe.com)

If you are experiencing some problems with any of our products or just need additional information, please place your ticket at [www.mikroe.com/esupport](http://www.mikroe.com/esupport)

If you have any questions, comments or business proposals,  
do not hesitate to contact us at [office@mikroe.com](mailto:office@mikroe.com)

MINI-M4 for STM32  
ver. 1.00



0 10000 022894