

Features

- 10 μ s of short-circuit withstand time
- $V_{CE(sat)} = 1.85$ V (typ.) @ $I_C = 25$ A
- Tight parameters distribution
- Safer paralleling
- Low thermal resistance
- Soft and fast recovery antiparallel diode

Applications

- Industrial drives
- UPS
- Solar
- Welding

Figure 1. Internal schematic diagram

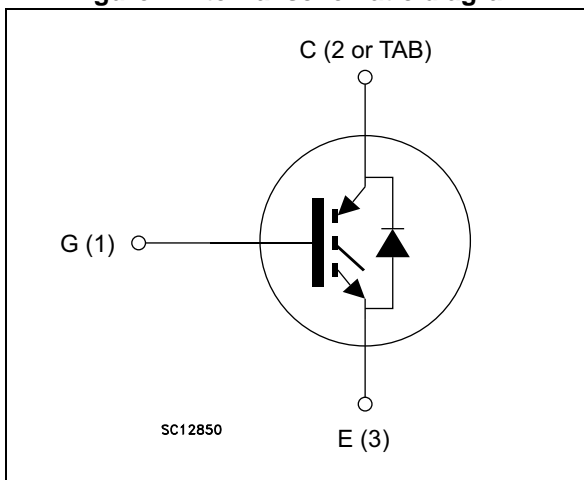

Description

This device is an IGBT developed using an advanced proprietary trench gate field-stop structure. The device is part of the M series of IGBTs, which represent an optimum compromise in performance to maximize the efficiency of inverter systems where low-loss and short circuit capability are essential. Furthermore, a positive $V_{CE(sat)}$ temperature coefficient and tight parameter distribution result in safer paralleling operation.

Table 1. Device summary

Order code	Marking	Package	Packaging
STGW25M120DF3	G25M120DF3	TO-247	Tube
STGWA25M120DF3	G25M120DF3	TO-247 long leads	Tube

Contents

- 1 Electrical ratings 3**
- 2 Electrical characteristics 4**
 - 2.1 Electrical characteristics (curves) 6
- 3 Test circuits 12**
- 4 Package mechanical data 13**
 - 4.1 TO-247, STGW25M120DF3 13
 - 4.2 TO-247 long leads, STGWA25M120DF3 15
- 5 Revision history 17**

1 Electrical ratings

Table 2. Absolute maximum ratings

Symbol	Parameter	Value	Unit
V_{CES}	Collector-emitter voltage ($V_{GE} = 0$)	1200	V
I_C	Continuous collector current at $T_C = 25\text{ °C}$	50	A
I_C	Continuous collector current at $T_C = 100\text{ °C}$	25	A
$I_{CP}^{(1)}$	Pulsed collector current	100	A
V_{GE}	Gate-emitter voltage	± 20	V
I_F	Continuous forward current at $T_C = 25\text{ °C}$	50	A
I_F	Continuous forward current at $T_C = 100\text{ °C}$	25	A
$I_{FP}^{(1)}$	Pulsed forward current	100	A
P_{TOT}	Total dissipation at $T_C = 25\text{ °C}$	375	W
T_{STG}	Storage temperature range	- 55 to 150	°C
T_J	Operating junction temperature	- 55 to 175	°C

1. Pulse width limited by maximum junction temperature.

Table 3. Thermal data

Symbol	Parameter	Value	Unit
R_{thJC}	Thermal resistance junction-case IGBT	0.4	°C/W
R_{thJC}	Thermal resistance junction-case diode	0.96	°C/W
R_{thJA}	Thermal resistance junction-ambient	50	°C/W

2 Electrical characteristics

$T_J = 25\text{ °C}$ unless otherwise specified.

Table 4. Static characteristics

Symbol	Parameter	Test conditions	Min.	Typ.	Max.	Unit
$V_{(BR)CES}$	Collector-emitter breakdown voltage ($V_{GE} = 0$)	$I_C = 2\text{ mA}$	1200			V
$V_{CE(sat)}$	Collector-emitter saturation voltage	$V_{GE} = 15\text{ V}, I_C = 25\text{ A}$		1.85	2.3	V
		$V_{GE} = 15\text{ V}, I_C = 25\text{ A}, T_J = 125\text{ °C}$		2.1		
		$V_{GE} = 15\text{ V}, I_C = 25\text{ A}, T_J = 175\text{ °C}$		2.2		
V_F	Forward on-voltage	$I_F = 25\text{ A}$		2.95	4.1	V
		$I_F = 25\text{ A}, T_J = 125\text{ °C}$		2.25		V
		$I_F = 25\text{ A}, T_J = 175\text{ °C}$		1.9		V
$V_{GE(th)}$	Gate threshold voltage	$V_{CE} = V_{GE}, I_C = 1\text{ mA}$	5	6	7	V
I_{CES}	Collector cut-off current ($V_{GE} = 0$)	$V_{CE} = 1200\text{ V}$			25	μA
I_{GES}	Gate-emitter leakage current ($V_{CE} = 0$)	$V_{GE} = \pm 20\text{ V}$			250	nA

Table 5. Dynamic characteristics

Symbol	Parameter	Test conditions	Min.	Typ.	Max.	Unit
C_{ies}	Input capacitance	$V_{CE} = 25\text{ V}, f = 1\text{ MHz}, V_{GE} = 0$	-	1550	-	pF
C_{oes}	Output capacitance		-	180	-	pF
C_{res}	Reverse transfer capacitance		-	65	-	pF
Q_g	Total gate charge	$V_{CC} = 960\text{ V}, I_C = 25\text{ A}, V_{GE} = 15\text{ V},$ see Figure 30	-	85	-	nC
Q_{ge}	Gate-emitter charge		-	11.5	-	nC
Q_{gc}	Gate-collector charge		-	45.5	-	nC

Table 6. IGBT switching characteristics (inductive load)

Symbol	Parameter	Test conditions	Min.	Typ.	Max.	Unit
$t_{d(on)}$	Turn-on delay time	$V_{CE} = 600\text{ V}$, $I_C = 25\text{ A}$, $V_{GE} = 15\text{ V}$, $R_G = 15\ \Omega$ see Figure 29	-	28	-	ns
t_r	Current rise time		-	15	-	ns
$(di/dt)_{on}$	Turn-on current slope		-	1370	-	A/ μ s
$t_{d(off)}$	Turn-off delay time		-	150	-	ns
t_f	Current fall time		-	155	-	ns
$E_{on}^{(1)}$	Turn-on switching losses		-	0.85	-	mJ
$E_{off}^{(2)}$	Turn-off switching losses		-	1.3	-	mJ
E_{ts}	Total switching losses	-	2.15	-	mJ	
$t_{d(on)}$	Turn-on delay time	$V_{CE} = 600\text{ V}$, $I_C = 25\text{ A}$, $R_G = 15\ \Omega$, $V_{GE} = 15\text{ V}$, $T_J = 175\text{ }^\circ\text{C}$, see Figure 29	-	28	-	ns
t_r	Current rise time		-	17	-	ns
$(di/dt)_{on}$	Turn-on current slope		-	1270	-	A/ μ s
$t_{d(off)}$	Turn-off delay time		-	155	-	ns
t_f	Current fall time		-	240	-	ns
$E_{on}^{(1)}$	Turn-on switching losses		-	1.6	-	mJ
$E_{off}^{(2)}$	Turn-off switching losses		-	1.9	-	mJ
E_{ts}	Total switching losses	-	3.5	-	mJ	
t_{sc}	Short-circuit withstand time	$V_{CC} \leq 600\text{ V}$, $V_{GE} = 15\text{ V}$, $T_{Jstart} \leq 150\text{ }^\circ\text{C}$	10		-	μ s

1. Energy losses include reverse recovery of the diode.
2. Turn-off losses include also the tail of the collector current.

Table 7. Diode switching characteristics (inductive load)

Symbol	Parameter	Test conditions	Min.	Typ.	Max.	Unit
t_{rr}	Reverse recovery time	$I_F = 25\text{ A}$, $V_R = 600\text{ V}$, $V_{GE} = 15\text{ V}$, see Figure 29 $di/dt = 1000\text{ A}/\mu\text{s}$	-	265	-	ns
Q_{rr}	Reverse recovery charge		-	1.2	-	μ C
I_{rrm}	Reverse recovery current		-	19	-	A
dl_{rr}/dt	Peak rate of fall of reverse recovery current during t_b		-	1090	-	A/ μ s
E_{rr}	Reverse recovery energy		-	0.22	-	mJ
t_{rr}	Reverse recovery time	$I_F = 25\text{ A}$, $V_R = 600\text{ V}$, $V_{GE} = 15\text{ V}$, $T_J = 175\text{ }^\circ\text{C}$, see Figure 29 $di/dt = 1000\text{ A}/\mu\text{s}$	-	585	-	ns
Q_{rr}	Reverse recovery charge		-	5	-	μ C
I_{rrm}	Reverse recovery current		-	30	-	A
dl_{rr}/dt	Peak rate of fall of reverse recovery current during t_b		-	270	-	A/ μ s
E_{rr}	Reverse recovery energy		-	0.75	-	mJ

2.1 Electrical characteristics (curves)

Figure 2. Power dissipation vs. case temperature

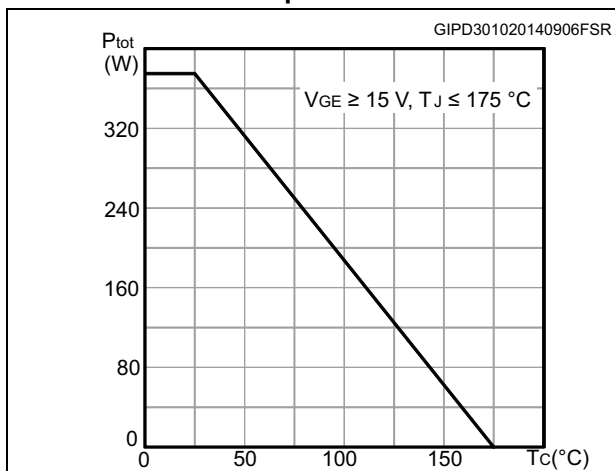

Figure 3. Collector current vs. case temperature

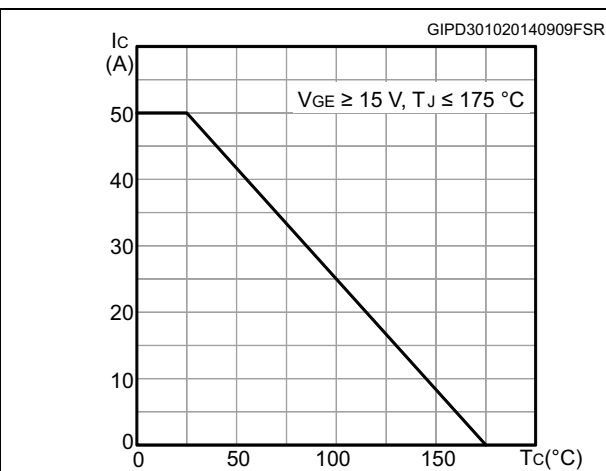

Figure 4. Output characteristics (T_J=25°C)

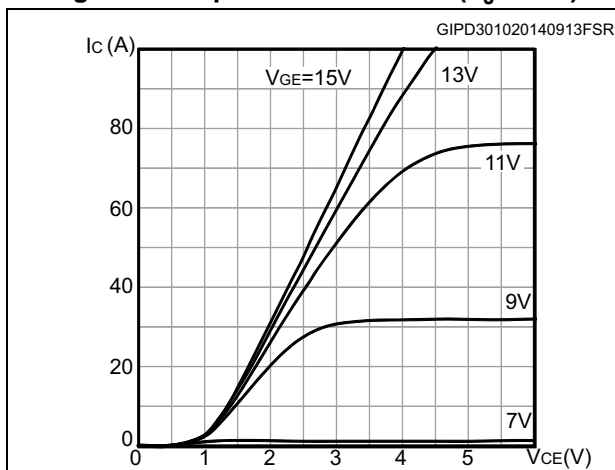

Figure 5. Output characteristics (T_J=175°C)

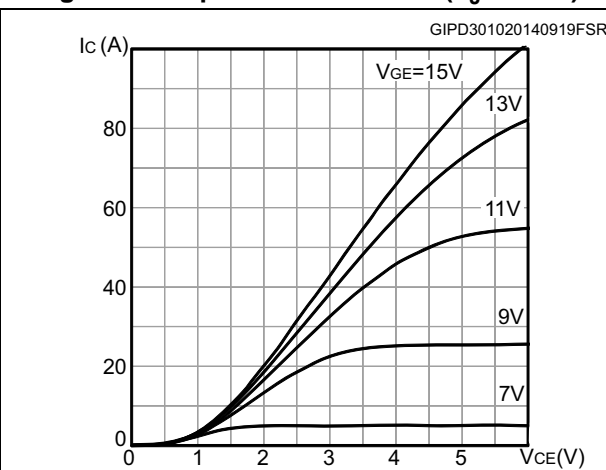

Figure 6. V_{CE(sat)} vs. junction temperature

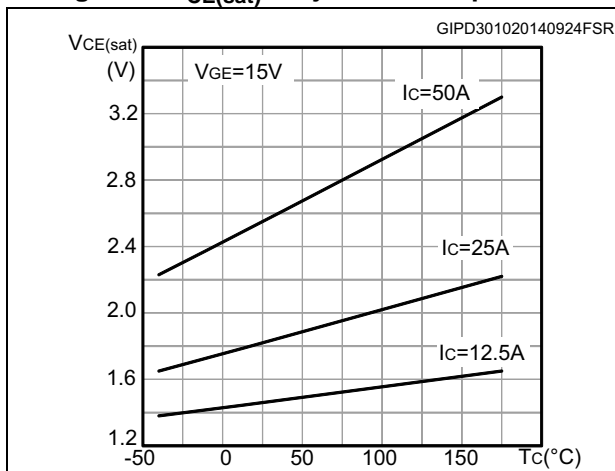

Figure 7. V_{CE(sat)} vs. collector current

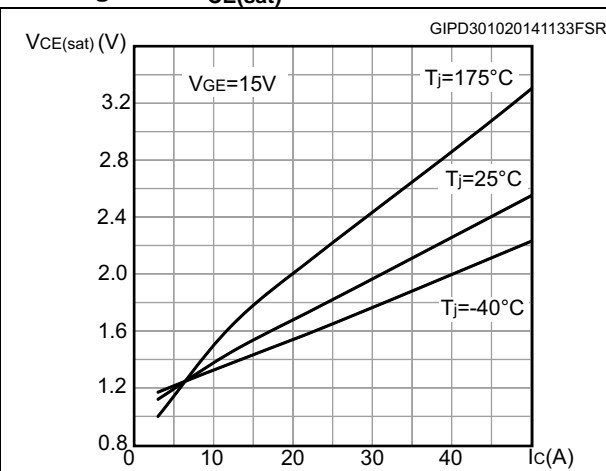

Figure 8. Collector current vs. switching frequency

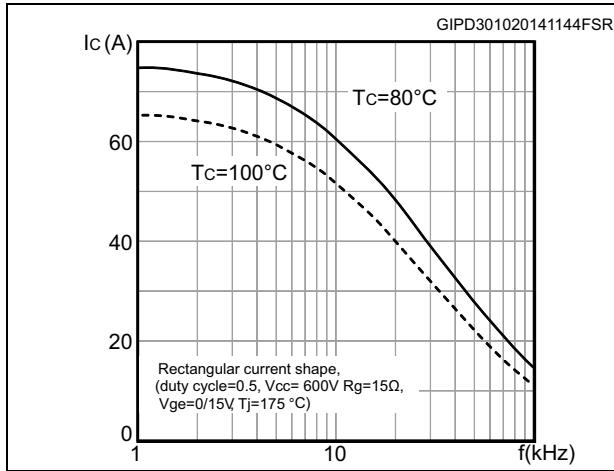

Figure 9. Safe operating area

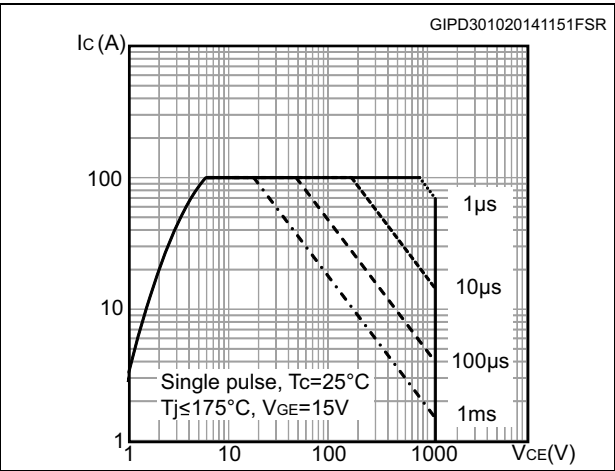

Figure 10. Transfer characteristics

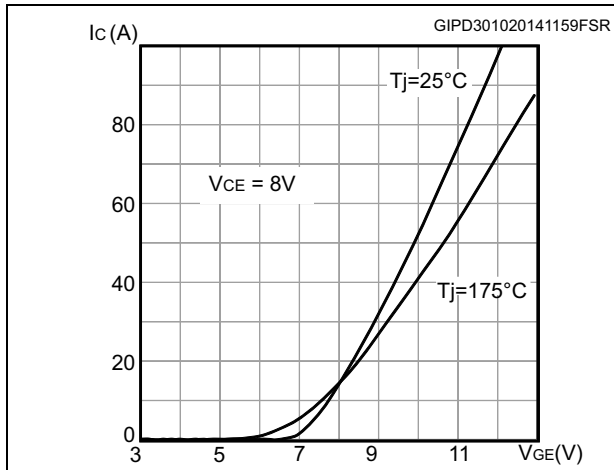

Figure 11. Diode V_F vs forward current

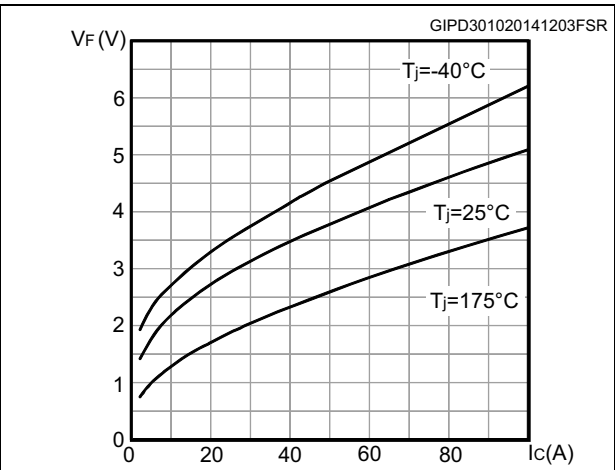

Figure 12. Normalized $V_{GE(th)}$ vs junction temperature

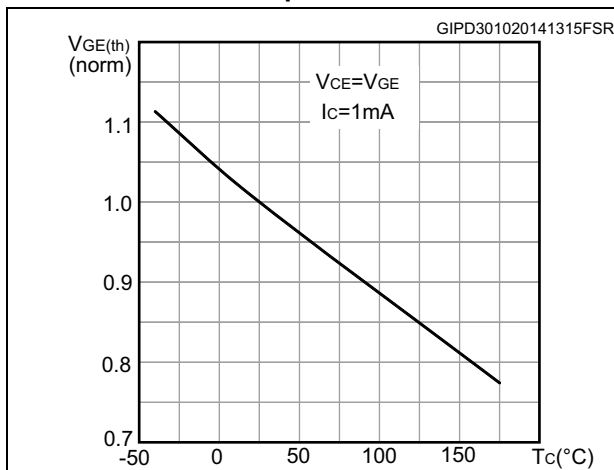

Figure 13. Normalized $V_{(BR)CES}$ vs. junction temperature

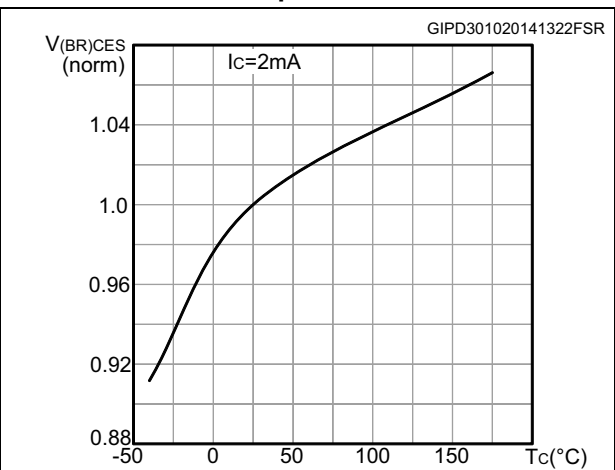

Figure 14. Capacitance variations

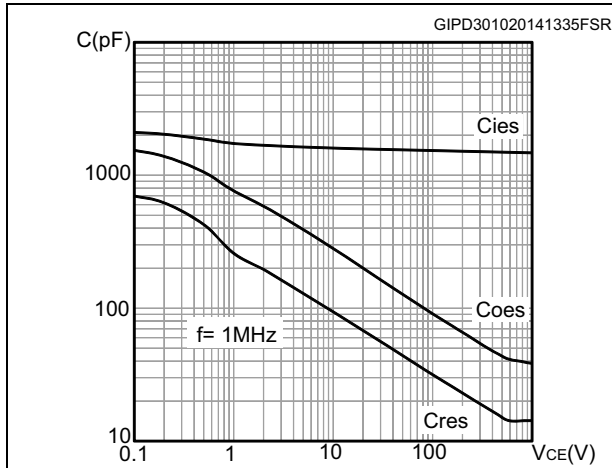

Figure 15. Gate charge vs. gate-emitter voltage

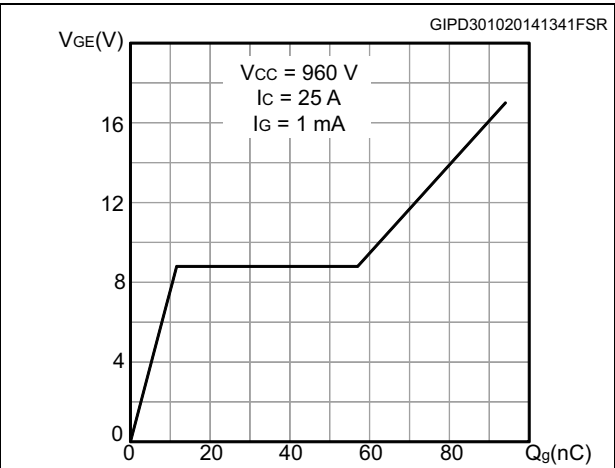

Figure 16. Switching losses vs. collector current

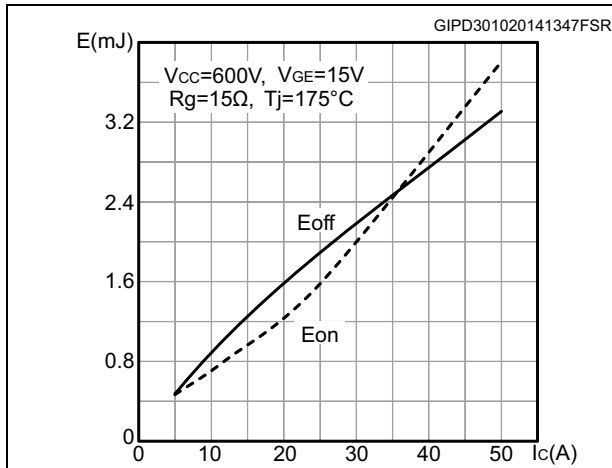

Figure 17. Switching losses vs. gate resistance

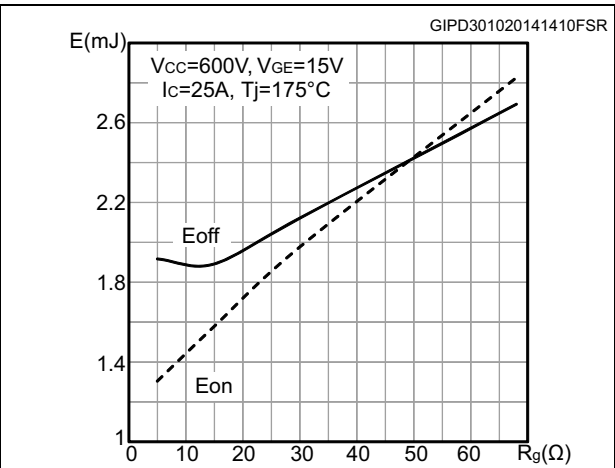

Figure 18. Switching losses vs. junction temperature

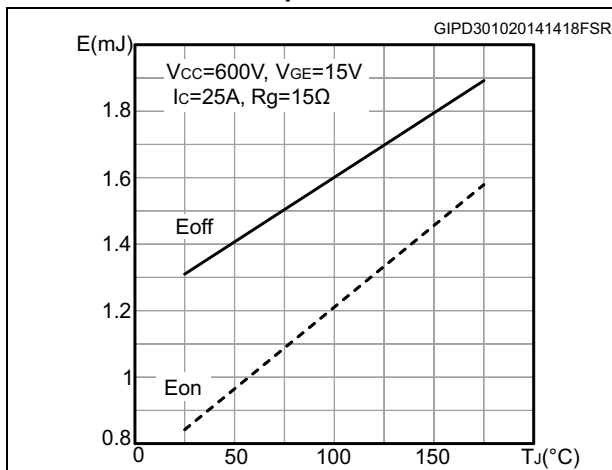

Figure 19. Switching losses vs. collector emitter voltage

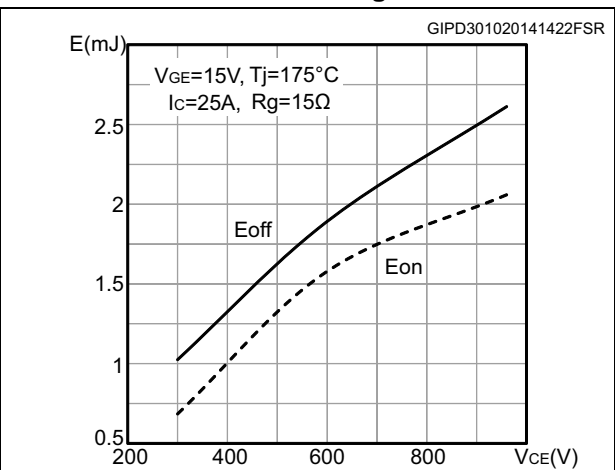

Figure 20. Short-circuit time and current vs. V_{GE} Figure 21. Switching times vs. collector current

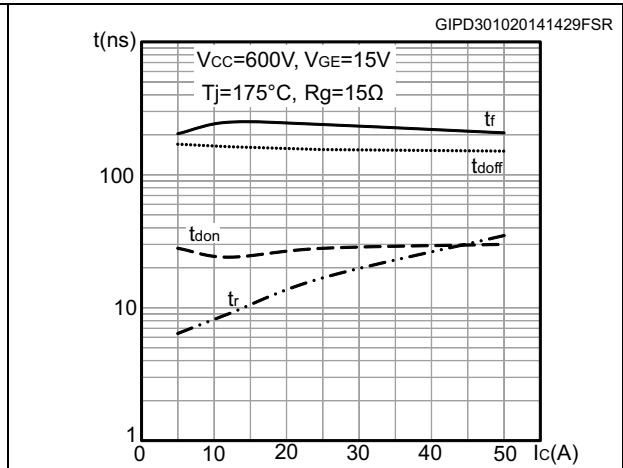
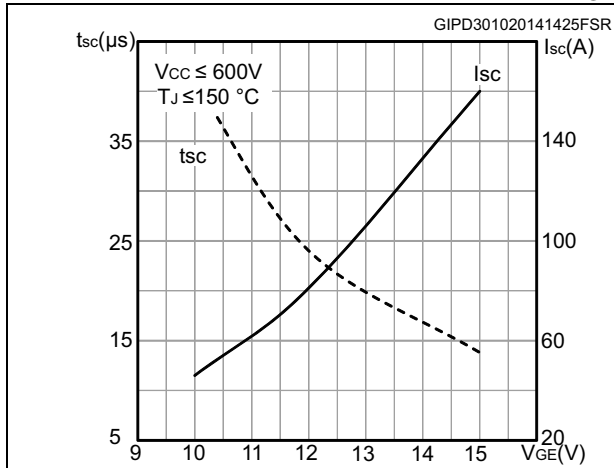

Figure 22. Switching times vs. gate resistance

Figure 23. Reverse recovery current vs. diode current slope

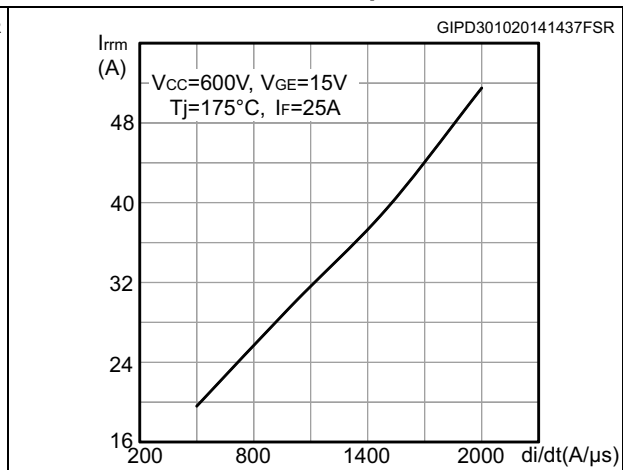
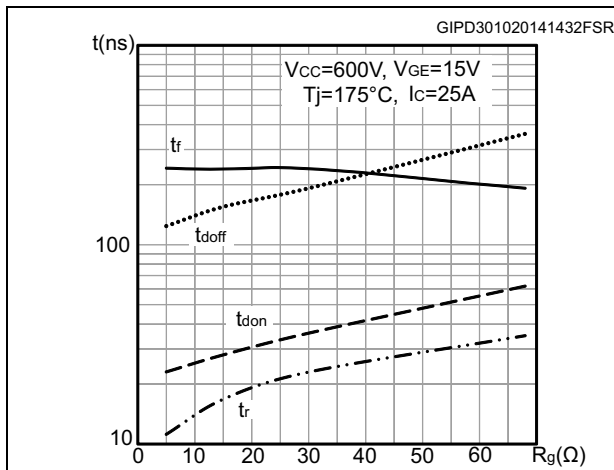

Figure 24. Reverse recovery time vs. diode current slope

Figure 25. Reverse recovery charge vs. diode current slope

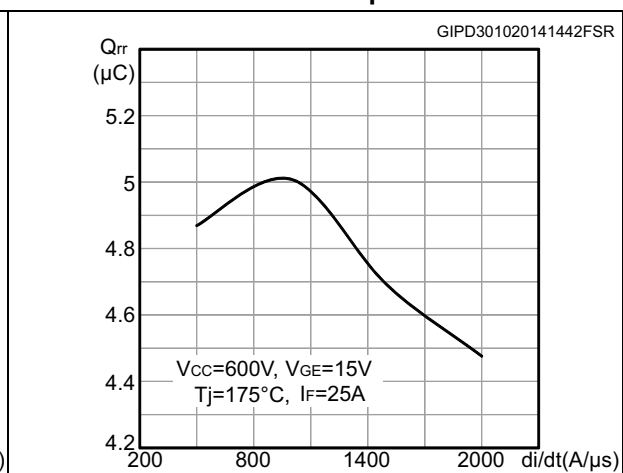
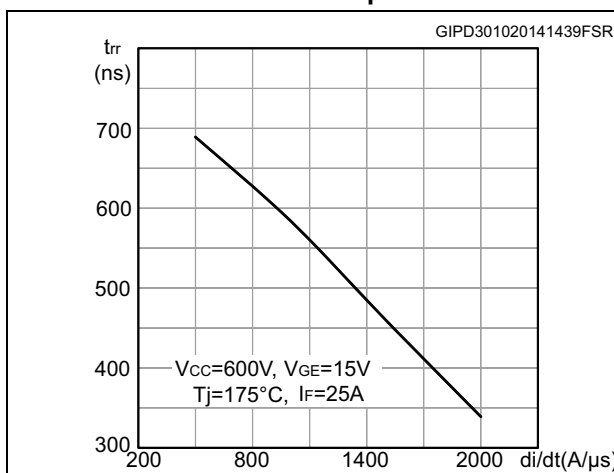

Figure 26. Reverse recovery energy vs. diode current slope

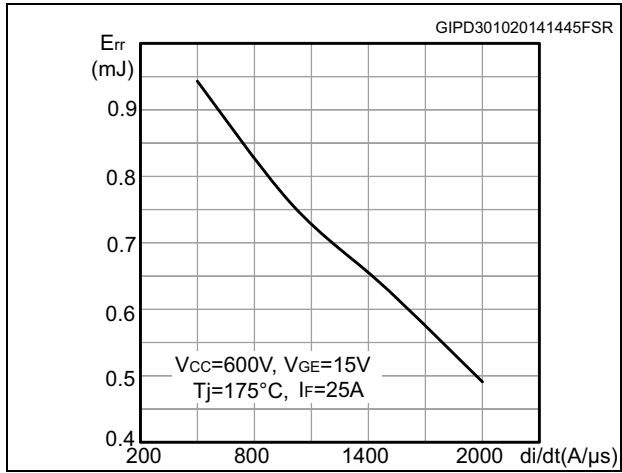

Figure 27. Thermal impedance for IGBT

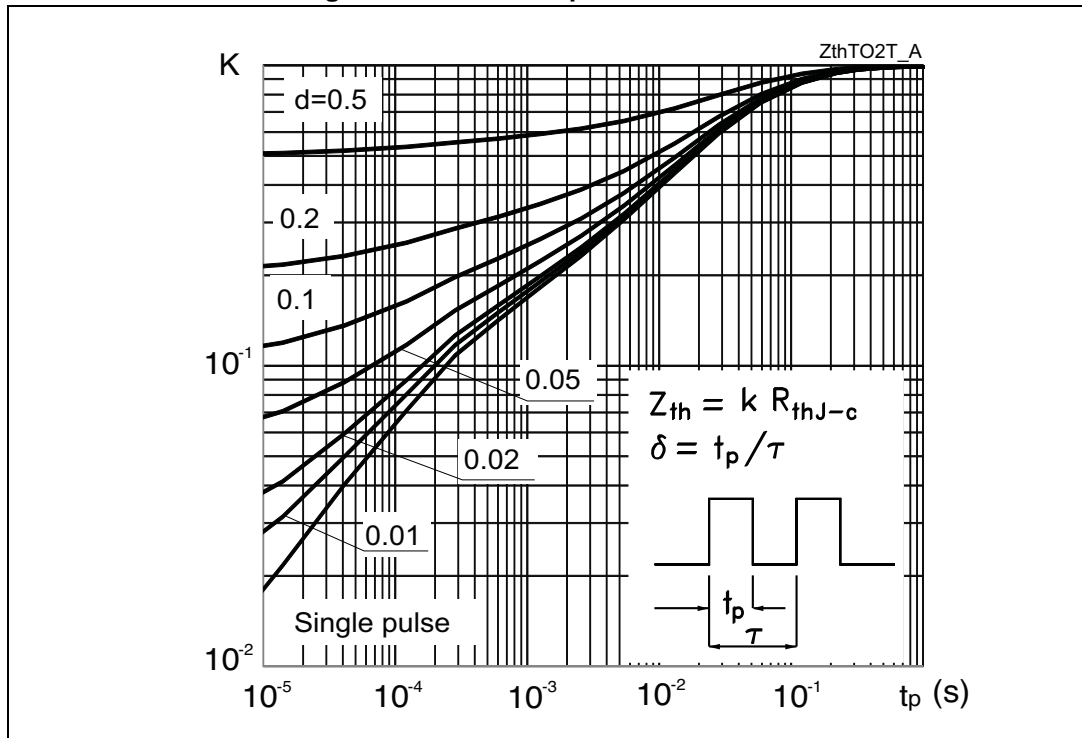
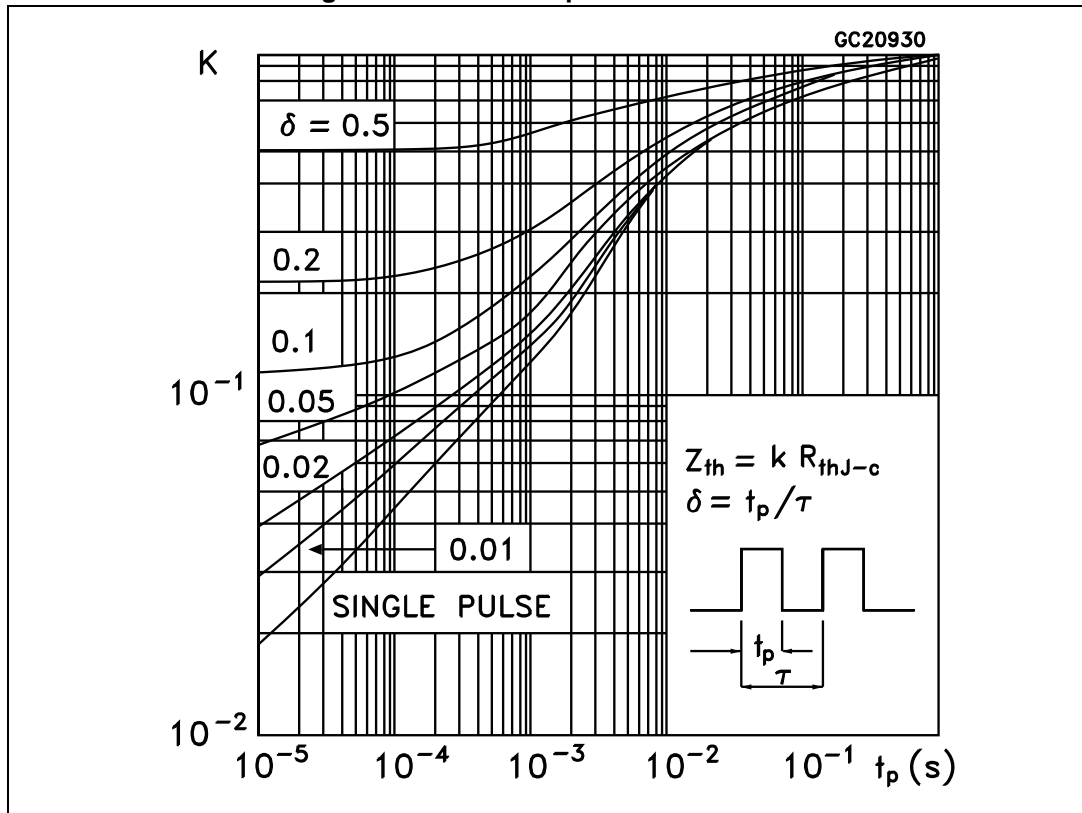

Figure 28. Thermal impedance for diode



3 Test circuits

Figure 29. Test circuit for inductive load switching



AM01504v1

Figure 30. Gate charge test

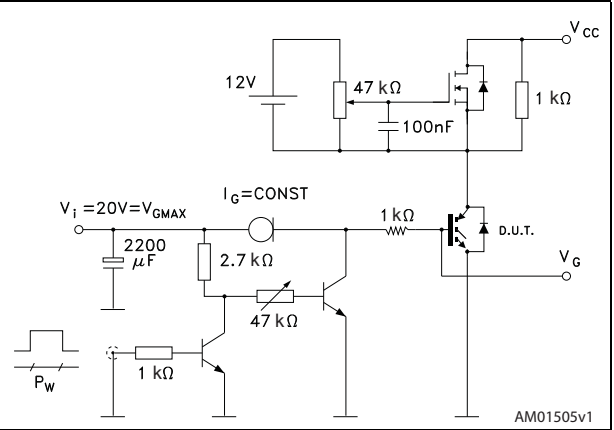

AM01505v1

Figure 31. Switching waveform

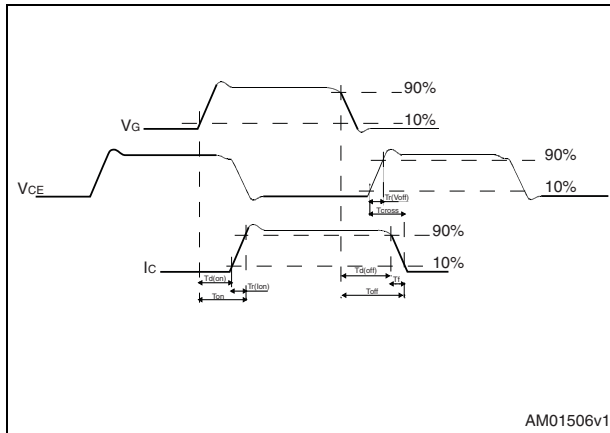

AM01506v1

Figure 32. Diode reverse recovery waveform

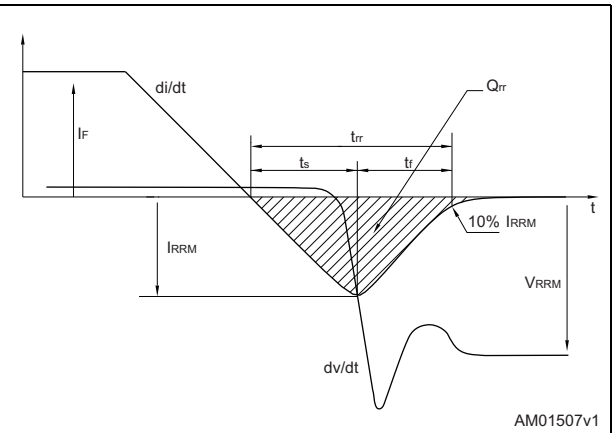

AM01507v1

4 Package mechanical data

In order to meet environmental requirements, ST offers these devices in different grades of ECOPACK® packages, depending on their level of environmental compliance. ECOPACK® specifications, grade definitions and product status are available at: www.st.com. ECOPACK is an ST trademark.

4.1 TO-247, STGW25M120DF3

Figure 33. TO-247 drawing

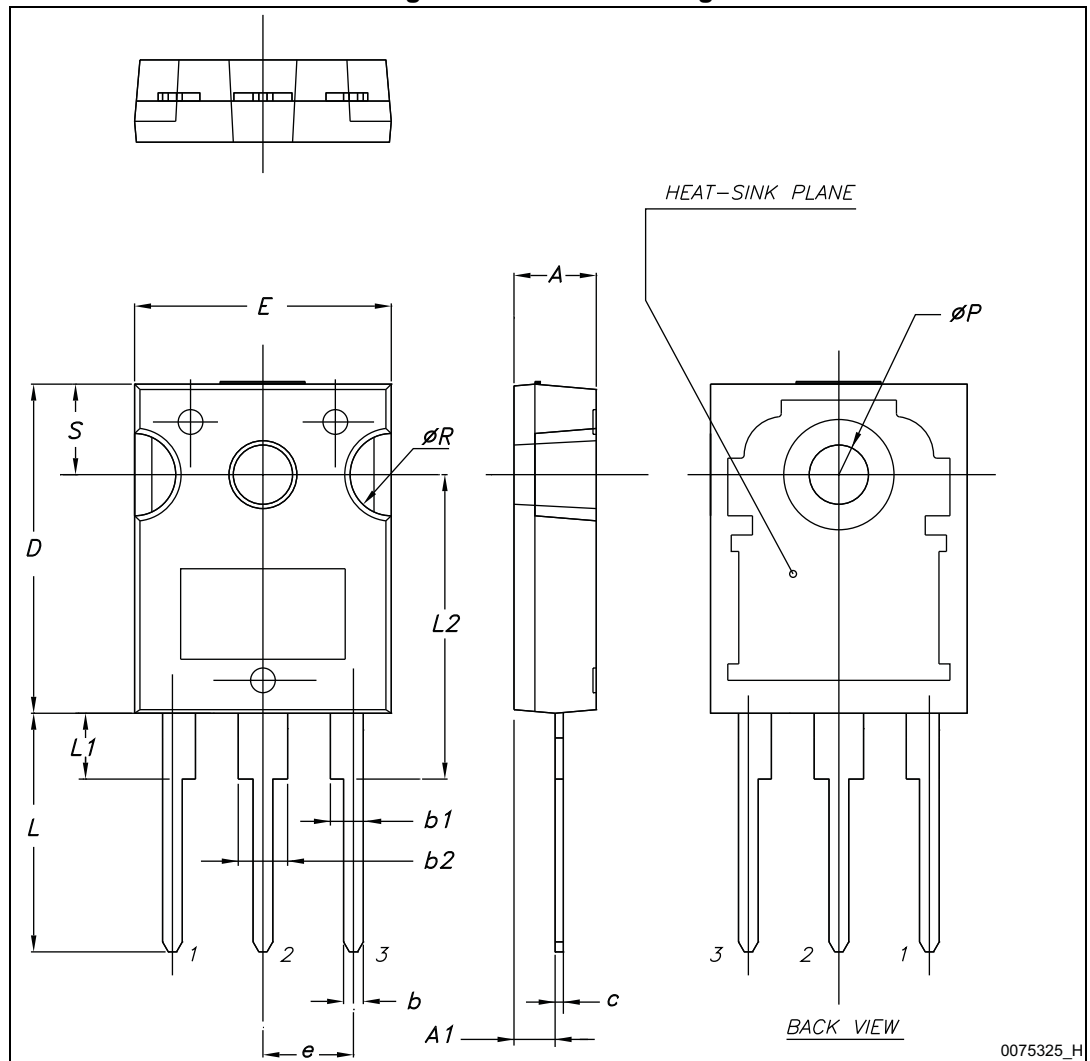

Table 8. TO-247 mechanical data

Dim.	mm.		
	Min.	Typ.	Max.
A	4.85		5.15
A1	2.20		2.60
b	1.0		1.40
b1	2.0		2.40
b2	3.0		3.40
c	0.40		0.80
D	19.85		20.15
E	15.45		15.75
e	5.30	5.45	5.60
L	14.20		14.80
L1	3.70		4.30
L2		18.50	
ØP	3.55		3.65
ØR	4.50		5.50
S	5.30	5.50	5.70

4.2 TO-247 long leads, STGWA25M120DF3

Figure 34. TO-247 long leads drawing

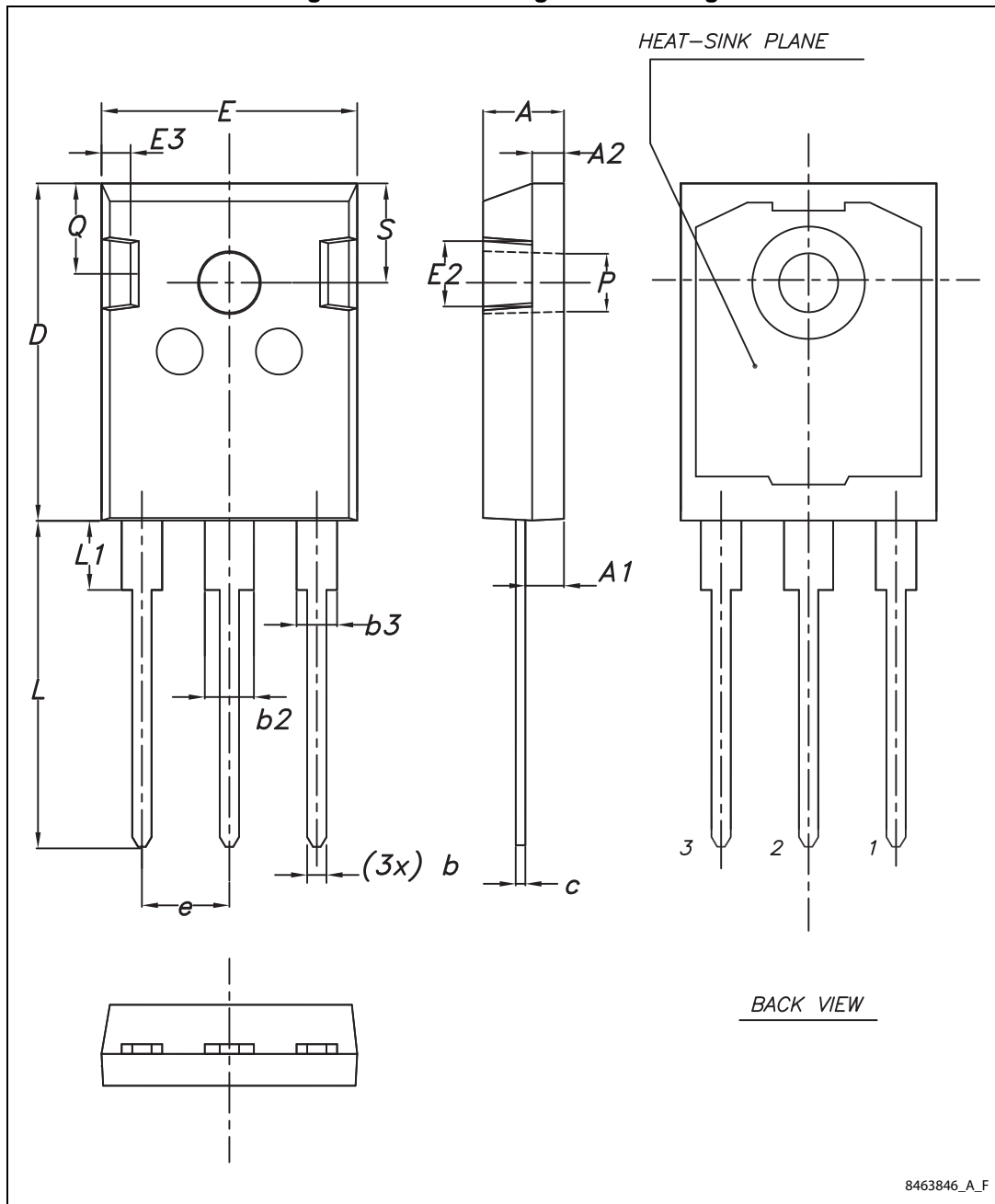

Table 9. TO-247 long leads mechanical data

Dim.	mm		
	Min.	Typ.	Max.
A	4.90	5.00	5.10
A1	2.31	2.41	2.51
A2	1.90	2.00	2.10
b	1.16		1.26
b2			3.25
b3			2.25
c	0.59		0.66
D	20.90	21.00	21.10
E	15.70	15.80	15.90
E2	4.90	5.00	5.10
E3	2.40	2.50	2.60
e	5.34	5.44	5.54
L	19.80	19.92	20.10
L1			4.30
P	3.50	3.60	3.70
Q	5.60		6.00
S	6.05	6.15	6.25

5 Revision history

Table 10. Document revision history

Date	Revision	Changes
22-Apr-2014	1	Initial release.
31-Oct-2014	2	Document status promoted from preliminary to production data. Updated all the document accordingly. Added Section 2.1: Electrical characteristics (curves) . Updated Section 4: Package mechanical data .

IMPORTANT NOTICE – PLEASE READ CAREFULLY

STMicroelectronics NV and its subsidiaries ("ST") reserve the right to make changes, corrections, enhancements, modifications, and improvements to ST products and/or to this document at any time without notice. Purchasers should obtain the latest relevant information on ST products before placing orders. ST products are sold pursuant to ST's terms and conditions of sale in place at the time of order acknowledgement.

Purchasers are solely responsible for the choice, selection, and use of ST products and ST assumes no liability for application assistance or the design of Purchasers' products.

No license, express or implied, to any intellectual property right is granted by ST herein.

Resale of ST products with provisions different from the information set forth herein shall void any warranty granted by ST for such product.

ST and the ST logo are trademarks of ST. All other product or service names are the property of their respective owners.

Information in this document supersedes and replaces information previously supplied in any prior versions of this document.

© 2014 STMicroelectronics – All rights reserved