

8 A Snubberless™ Triac

Datasheet - production data

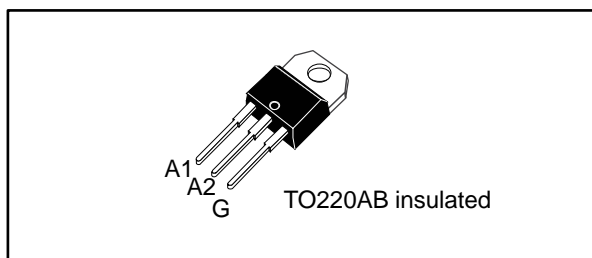

Features

- High static dV/dt
- High dynamic commutation
- 150 °C maximum T_j
- Three quadrants
- Built-in ceramic for tab insulation
- Compliance to UL1557 standard (ref : E81734)
- ECOPACK®2 compliant component
- Complies with UL94,V0
- Surge capability V_{DSM} , $V_{RSM} = 900$ V

Benefits

- Device is less likely to have false turn-on thanks to high dV/dt
- Better turn-off in high temperature environments thanks to $(di/dt)_c$
- Increase of thermal margin due to extended working T_j up to 150 °C
- Better thermal resistance due to the ceramic inside the package

Applications

- General purpose AC line load switching
- Motor control circuits
- Home appliances
- Heating
- Lighting
- Inrush current limiting circuits
- Overvoltage crowbar protection

Description

Available in through-hole package, the T835T-8I Triac can be used for the on/off or phase angle control function in general purpose AC switching where high commutation capability is required. This device can be used without a snubber RC circuit when the limits defined are respected.

TO-220AB insulated provides tab insulation, UL1557 certified, rated at 2.5 kV RMS and UL-94, V0 resin compliance.

Package environmentally friendly ECOPACK®2 graded (RoHS and Halogen Free compliance).

Snubberless™ is a trademark of STMicroelectronics.

Figure 1: Functional diagram

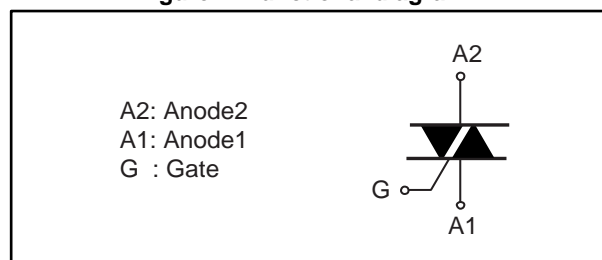

Table 1: Device summary

Symbol	Value	Unit
$I_{T(RMS)}$	8	A
V_{DRM}/V_{RRM}	800	V
V_{DSM}/V_{RSM}	900	V
I_{GT}	35	mA

1 Characteristics

Table 2: Absolute maximum ratings (limiting values)

Symbol	Parameter		Value	Unit	
$I_{T(RMS)}$	RMS on-state current (full sine wave)		$T_c = 118\text{ °C}$ 8	A	
I_{TSM}	Non repetitive surge peak on-state current, T_j initial = 25 °C		$t_p = 16.7\text{ ms}$ 63	A	
			$t_p = 20\text{ ms}$ 60		
I^2t	I^2t value for fusing, $t_p = 10\text{ ms}$		T_j initial = 25 °C 24	A ² s	
di/dt	Critical rate of rise of on-state current, $I_G = 2 \times I_{GT}$, $t_r \leq 100\text{ ns}$	$T_j = 150\text{ °C}$	$f = 100\text{ Hz}$	100	A/ μ s
			$T_j = 150\text{ °C}$ 600	V	
V_{DRM}/V_{RRM}	Repetitive peak off-state voltage		$T_j = 150\text{ °C}$ 800	800	V
			$T_j = 125\text{ °C}$ 900	V	
V_{DSM}/V_{RSM}	Non Repetitive peak off-state voltage		$t_p = 10\text{ ms}$ 900	V	
I_{GM}	Peak gate current	$t_p = 20\text{ }\mu$ s	$T_j = 150\text{ °C}$ 4	A	
$P_{G(AV)}$	Average gate power dissipation		$T_j = 150\text{ °C}$ 1	W	
T_{stg}	Storage junction temperature range			-40 to +150	°C
T_j	Operating junction temperature range			-40 to +150	°C
T_L	Maximum lead temperature for soldering during 10 s			260	°C
V_{ins}	Insulation RMS voltage, 1 minute, UL1557 certified (E81734)			2.5	kV

Table 3: Electrical characteristics ($T_j = 25\text{ °C}$, unless otherwise specified)

Symbol	Test Conditions		Value	Unit		
$I_{GT}^{(1)}$	$V_D = 12\text{ V}$, $R_L = 30\text{ }\Omega$	I - II - III	Min.	1.75	mA	
	$V_D = 12\text{ V}$, $R_L = 30\text{ }\Omega$	I - II - III	Max.	35	mA	
V_{GT}	$V_D = 12\text{ V}$, $R_L = 30\text{ }\Omega$	I - II - III	Max.	1.3	V	
V_{GD}	$V_D = V_{DRM}$, $R_L = 3.3\text{ k}\Omega$, $T_j = 150\text{ °C}$		I - II - III	Min.	0.2	V
I_L	$I_G = 1.2 \times I_{GT}$		I - III	Max.	60	mA
			II	Max.	70	mA
I_H	$I_T = 500\text{ mA}$, gate open		Max.	40	mA	
dV/dt	$V_D = 536\text{ V}$, gate open	$T_j = 125\text{ °C}$	Min.	2000	V/ μ s	
	$V_D = 402\text{ V}$, gate open	$T_j = 150\text{ °C}$		1000	V/ μ s	
$(di/dt)_c$	Without snubber, $(dV/dt)_c > 20\text{ V}/\mu$ s		$T_j = 125\text{ °C}$	Min.	8	A/ms
			$T_j = 150\text{ °C}$		4	A/ms

Notes:

(1)For both polarities of A2 referenced to A1.

Table 4: Static characteristics

Symbol	Test conditions	T _j		Value	Unit
V _{TM} ⁽¹⁾	I _T = 11.3 A, t _p = 380 μs	25 °C	Max.	1.60	V
V _{TO}	Threshold on-state voltage	150 °C	Max.	0.87	V
R _D	Dynamic resistance	150 °C	Max.	80	mΩ
I _{DRM} /I _{RDM}	V _{DRM} = V _{RDM} = 800 V	25 °C	Max.	5	μA
		125 °C		1.0	mA
	V _{DRM} = V _{RDM} = 600 V	150 °C	Max.	2.5	mA

Notes:

⁽¹⁾For both polarities of A2 referenced to A1.

Table 5: Thermal resistance

Symbol	Parameter		Value	Unit
R _{th(j-c)}	Junction to case (AC)	Max.	2.8	°C/W
R _{th(j-a)}	Junction to ambient	Typ.	60	

1.1 Characteristics (curves)

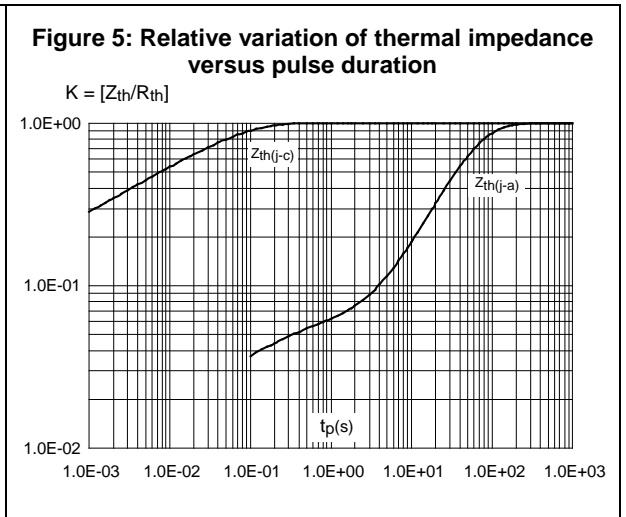
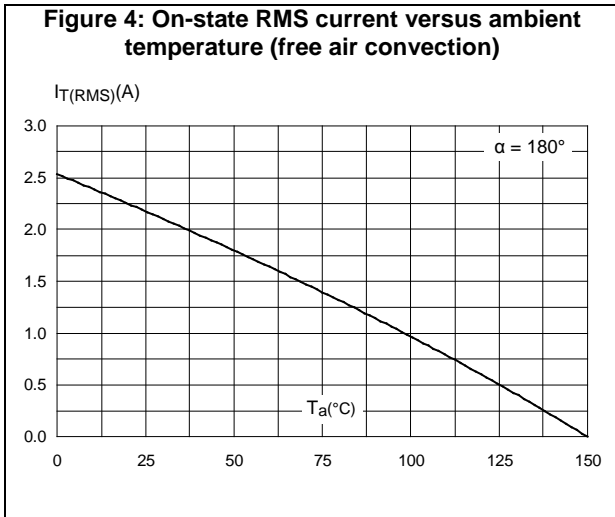
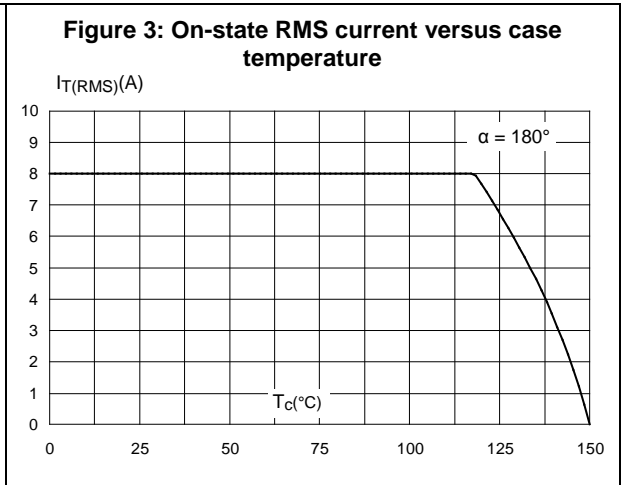
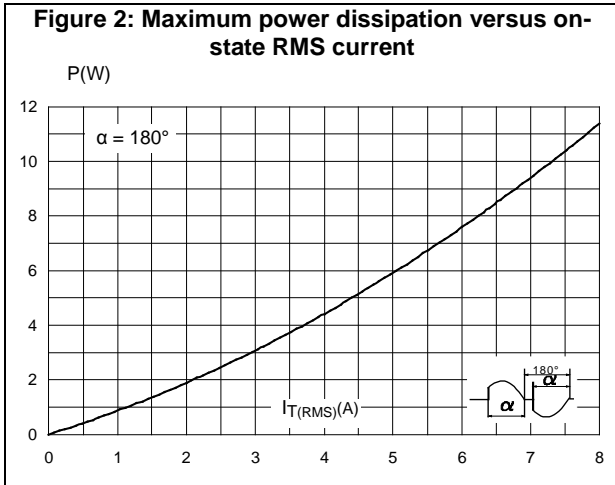

Figure 6: Relative variation of gate trigger voltage and current versus junction temperature (typical values)

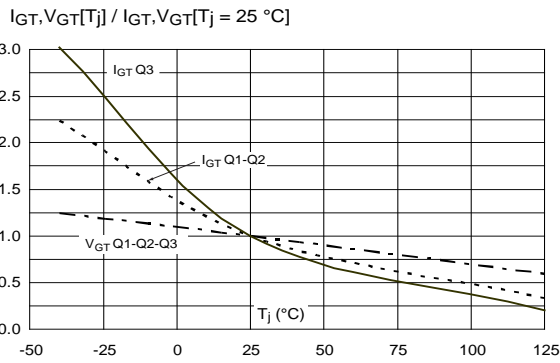

Figure 7: Relative variation of holding current and latching current versus junction temperature (typical values)

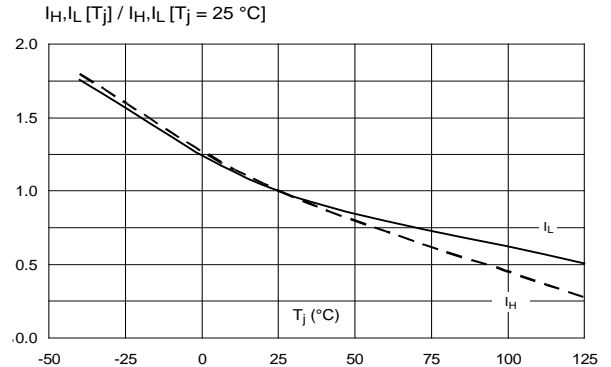

Figure 8: Surge peak on-state current versus number of cycles

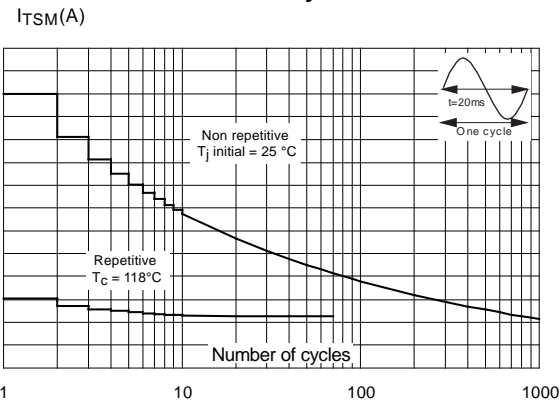

Figure 9: Non repetitive surge peak on-state current for a sinusoidal pulse with width t_p < 10 ms

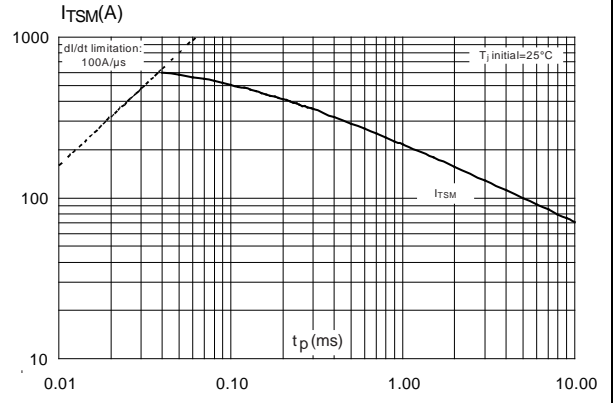

Figure 10: On-state characteristics (maximum values)

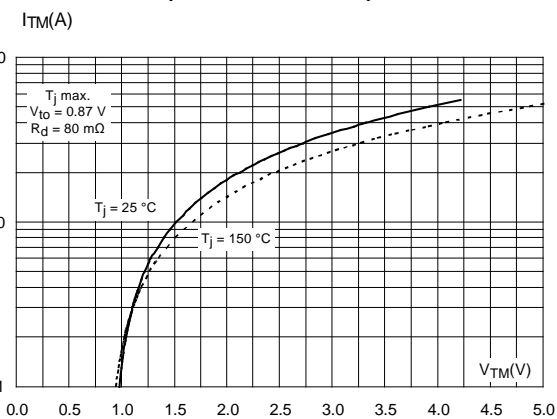
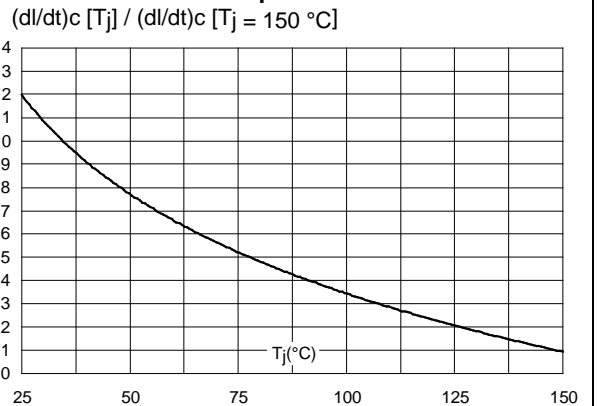
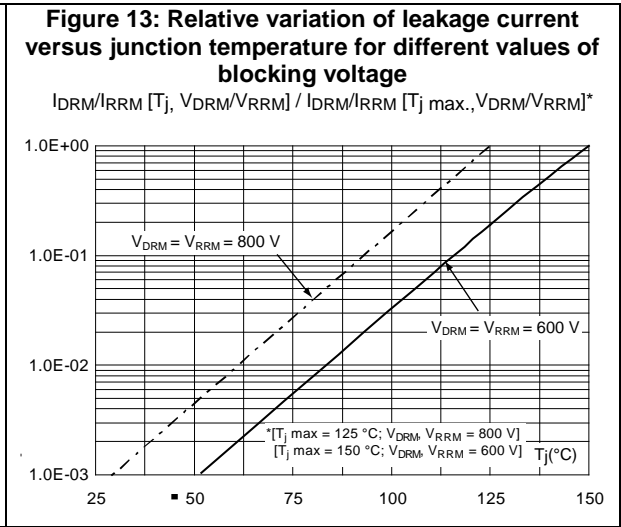
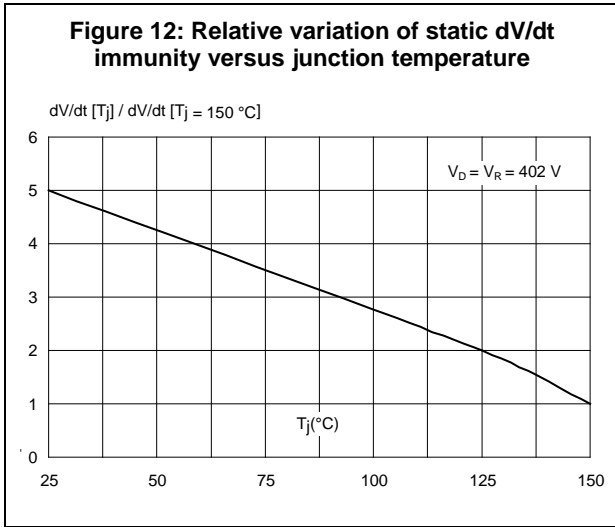

Figure 11: Relative variation of critical rate of decrease of main current versus junction temperature





2 Package information

In order to meet environmental requirements, ST offers these devices in different grades of ECOPACK® packages, depending on their level of environmental compliance. ECOPACK® specifications, grade definitions and product status are available at: www.st.com. ECOPACK® is an ST trademark.

- ECOPACK®2 (Lead-free plating and Halogen free package compliance)
- Lead-free package leads finishing
- Halogen-free molding compound resin meets UL94 standard level V0.
- Recommended torque (for through-hole package): 0.4 to 0.6 N·m

2.1 TO-220AB Insulated package information

Figure 14: TO-220AB Insulated package outline

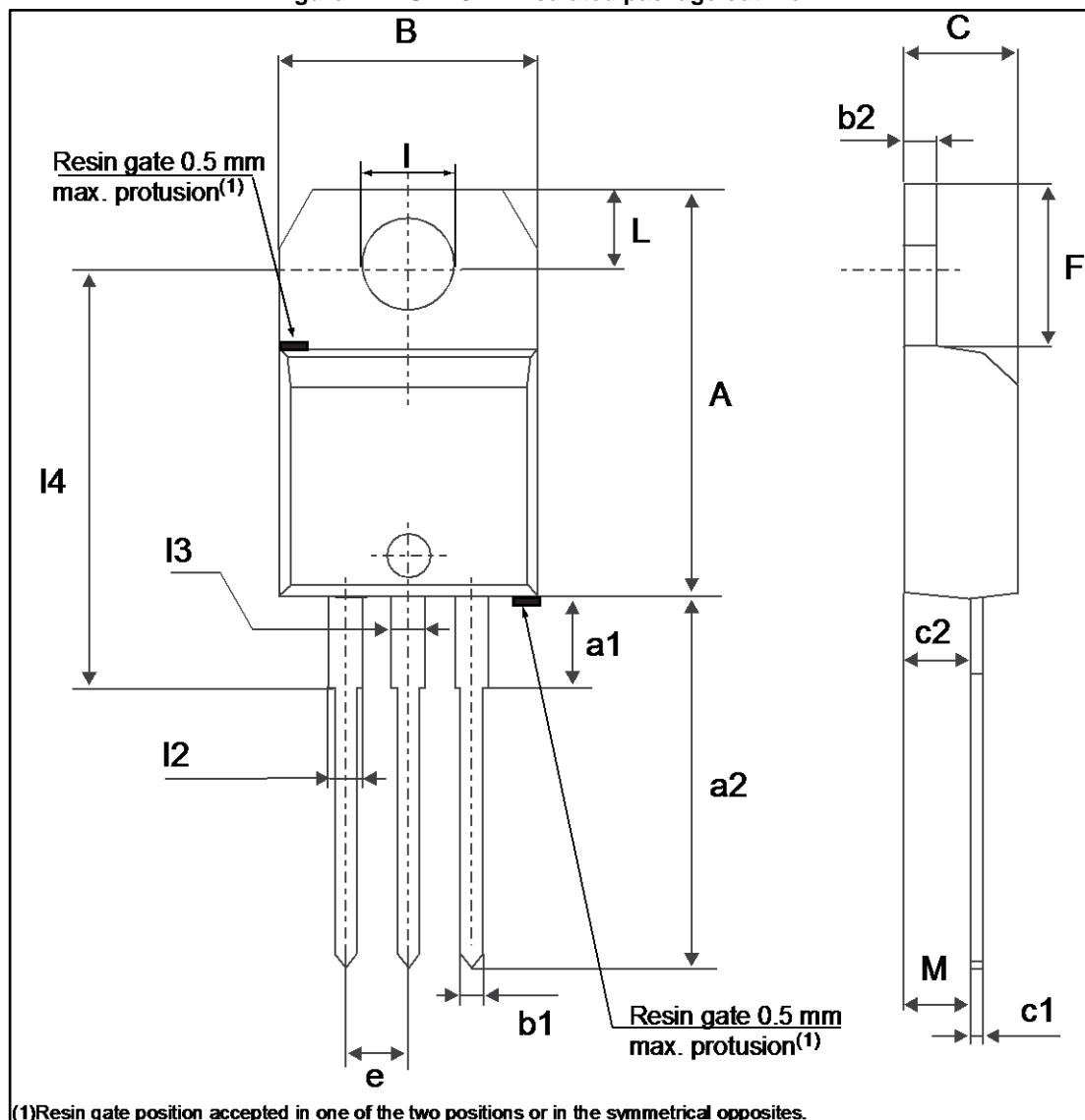

Table 6: TO-220AB Insulated package mechanical data

Ref.	Dimensions					
	Millimeters			Inches ⁽¹⁾		
	Min.	Typ.	Max.	Min.	Typ.	Max.
A	15.20		15.90	0.5984		0.6260
a1		3.75			0.1476	
a2	13.00		14.00	0.5118		0.5512
B	10.00		10.40	0.3937		0.4094
b1	0.61		0.88	0.0240		0.0346
b2	1.23		1.32	0.0484		0.0520
C	4.40		4.60	0.1732		0.1811
c1	0.49		0.70	0.0193		0.0276
c2	2.40		2.72	0.0945		0.1071
e	2.40		2.70	0.0945		0.1063
F	6.20		6.60	0.2441		0.2598
I	3.73		3.88	0.1469		0.1528
L	2.65		2.95	0.1043		0.1161
I2	1.14		1.70	0.0449		0.0669
I3	1.14		1.70	0.0449		0.0669
I4	15.80	16.40	16.80	0.6220	0.6457	0.6614
M		2.6			0.1024	

Notes:

⁽¹⁾Inch dimensions are for reference only.

3 Ordering information

Figure 15: Ordering information scheme

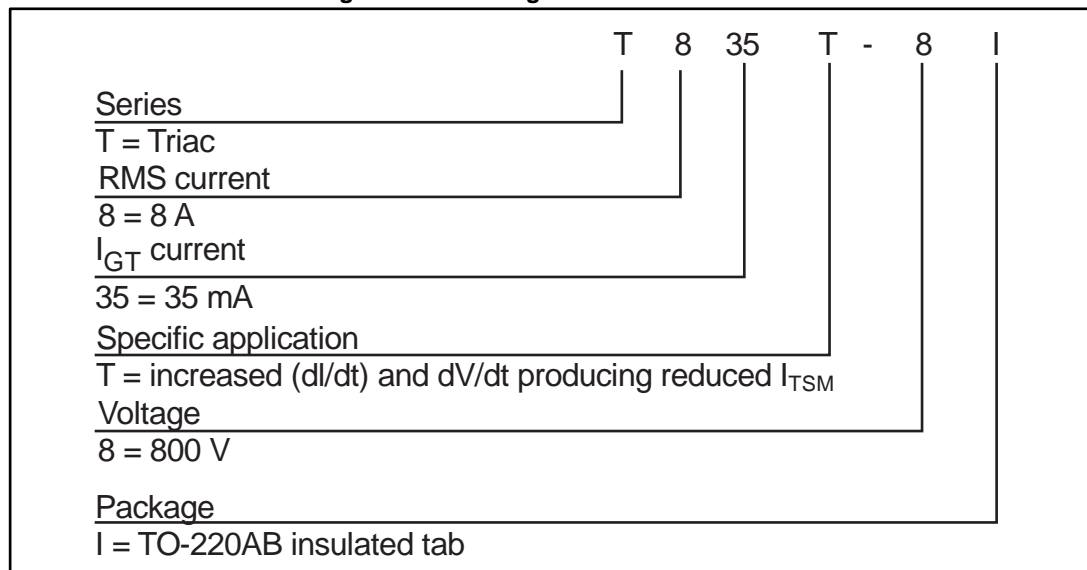

Table 7: Ordering information

Order code	Marking	Package	Weight	Base qty.	Delivery mode
T835T-8I	T835T-8I	TO-220AB insulated	2.3 g	50	Tube

4 Revision history

Table 8: Document revision history

Date	Revision	Changes
17-Oct-2017	1	Initial release.
06-Nov-2017	2	Updated Table 4: "Static characteristics" .

IMPORTANT NOTICE – PLEASE READ CAREFULLY

STMicroelectronics NV and its subsidiaries ("ST") reserve the right to make changes, corrections, enhancements, modifications, and improvements to ST products and/or to this document at any time without notice. Purchasers should obtain the latest relevant information on ST products before placing orders. ST products are sold pursuant to ST's terms and conditions of sale in place at the time of order acknowledgement.

Purchasers are solely responsible for the choice, selection, and use of ST products and ST assumes no liability for application assistance or the design of Purchasers' products.

No license, express or implied, to any intellectual property right is granted by ST herein.

Resale of ST products with provisions different from the information set forth herein shall void any warranty granted by ST for such product.

ST and the ST logo are trademarks of ST. All other product or service names are the property of their respective owners.

Information in this document supersedes and replaces information previously supplied in any prior versions of this document.

© 2017 STMicroelectronics – All rights reserved