

Conductive Sensors 2 to 4-point level controller Type CL with potentiometer

CARLO GAVAZZI



- Conductive level controller
- Adjustment of sensitivity – operating resistance from 250Ω to 500KΩ
- Multiple combinations of filling and emptying applications
- Low-voltage AC electrodes
- Easy installation on DIN rails or with 11 pin circular plug
- Rated operational voltage:
24 VAC/DC, 115 VAC or 230 VAC
- Output 2x8A/250 VAC SPDT relay
- LED indication for: Output ON and Power ON



Product Description

μ-Processor based level controller for liquids with a wide sensitivity range (like sewage water, chemicals, salt water etc.). The controller has a separate output for alarm indication in case of a tank

running dry or if an overflow condition occurs.
8A SPDT/SPST relay output, NO/NC.
Sensitivity control by potentiometer level in 3 ranges.

Ordering Key

CLD4MA2DM24

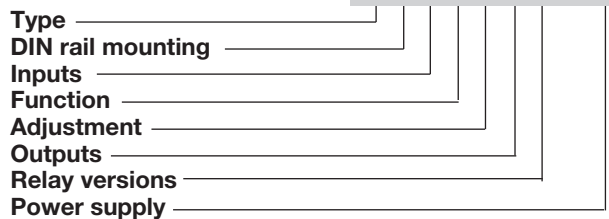

Type Selection

Mounting	Relay	Ordering no. Supply: 24 VAC/DC	Ordering no. Supply: 115 VAC	Ordering no. Supply: 230 VAC
DIN-rail	SPDT + SPST	CLD4MA2DM24	CLD4MA2D115	CLD4MA2D230
11-p circular plug	2 SPST	CLP4MA2AM24	CLP4MA2A115	CLP4MA2A230

Specifications

Rated operational voltage (U_B)			Dielectric voltage	>2.0 KVAC (rms) (contacts / electronics)
Pin 2 & 10	230	195 to 265 VAC, 45 to 65 Hz	Rated impulse withstand volt.	4 kV (1.2/50 μS) (contacts / electronics) (IEC 664)
	115	98 to 132 VAC, 45 to 65 Hz	Operating frequency (f)	
Supply class 2	24	19.2 to 28.8 VAC/DC	Relay output	0.5 HZ
Rated insulation voltage		<2.0 kVAC (rms)	Response time	
Rated impulse withstand voltage		4 kV (1.2/50 μs) (line/neutral)	OFF-ON (t _{on})	1 s
Rated operational power			ON-OFF (t _{off})	1 s
AC supply		5 VA	Environment	
AC/DC supply		5 VA / 5 W	Overvoltage category	III (IEC 60664)
Delay on operate (t_v)		< 300 mS	Degree of protection	IP 20 (IEC 60529, 60947-1)
Outputs		Make or break on rotary-switch	Pollution degree	2 (IEC 60664/60664A, 60947-1)
Rated insulation voltage		250 VAC (rms) (cont./elec.)	Temperature	
Relay Rating (AgCdO)		μ (micro gap)	Operating	-20° to +50°C (-4° to + 122°F)
Resistive loads	AC1	8 A / 250 VAC (2500 VA)	Storage	-50° to +85°C (-58° to +185°F)
	DC1	1 A / 250 VDC (250 W) or 10 A / 25 VDC (250 W)	Housing material	
Small induc. Loads	AC15	0,4 A / 250 VAC	CLP	NORYL PPO, light grey
	DC13	0,4 A / 30 VDC	CLD	ABS VO, light grey
Mechanical life (typical)		≥ 30 x 10 ⁶ operations	Screw type	M3
		@ 18'000 imp/h	Tightening torque min/max	0.4Nm/0.8Nm
Electrical life (typical)	AC1	> 250'000 operations	Weight	
Level probe supply		Max. 5 VAC	AC supply	200 g
Level probe current		Max. 2 mA	AC/DC supply	125 g
Sensitivity		250Ω to 500KΩ	UL Approvals	cURus UL508, UL325, CSA-C22.2 No.247
		Factory settings standard range "S" 100KΩ	CE marking	Yes
Ranges L (Low sensitivity)		250 Ω to 5 KΩ, C _F * = 4.7 nF		
Ranges S (Standard sensitivity)		5 KΩ to 100 KΩ, C _F * = 2.2 nF		
Ranges H (High sensitivity)		50 KΩ to 500 KΩ, C _F * = 1.0 nF		

*C_F = maximum Cable Capacitance

Specifications are subject to change without notice (14.12.2015)



Mode of Operation

Connection cable

2, 3, 4 or 5 conductor PVC cable, normally screened. Cable length: max. 100 m. The resistance between the cores and the ground must be at least 500k. Normally, it is recommended to use a screened cable between probe and controller, e.g. where the cable is placed in parallel to the load cables (mains). The screen has to be connected to Y5 (reference).

react to the low current created when the electrodes are in contact with the liquid.

The reference (Ref) must be connected to the container or if the container consists of a non-conductive material, to an additional electrode. (To be connected to pin Y5).

In the diagram this electrode is shown by the dotted line.)

The alarm outputs utilize alarm - and Y1 for LoLo alarm - and Y4 for HiHi alarm outputs.

Example 1

The diagram shows the level control connected as max. and min. control, i.e. registration of 2 levels + 2 alarm levels. The relays

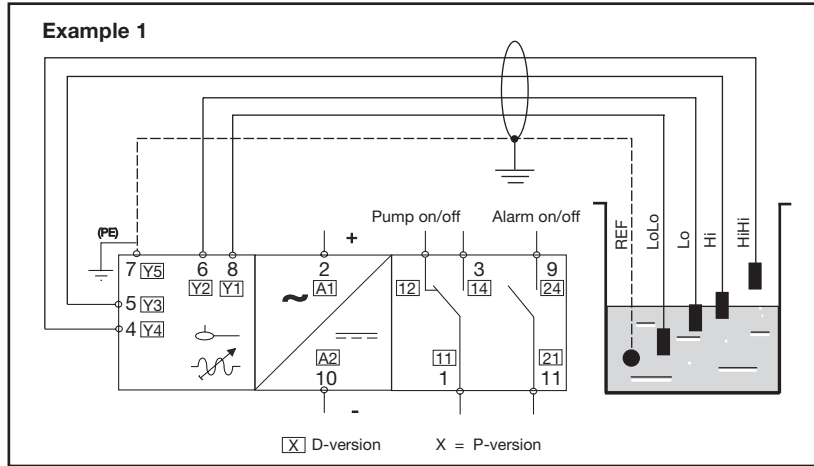

Operation Diagram

Function: Filling or Emptying

The Multifunction Controller can be used as a minimum-maximum control for two systems, a filling system and an emptying system, with the same kind of liquid to be measured and one common pump.

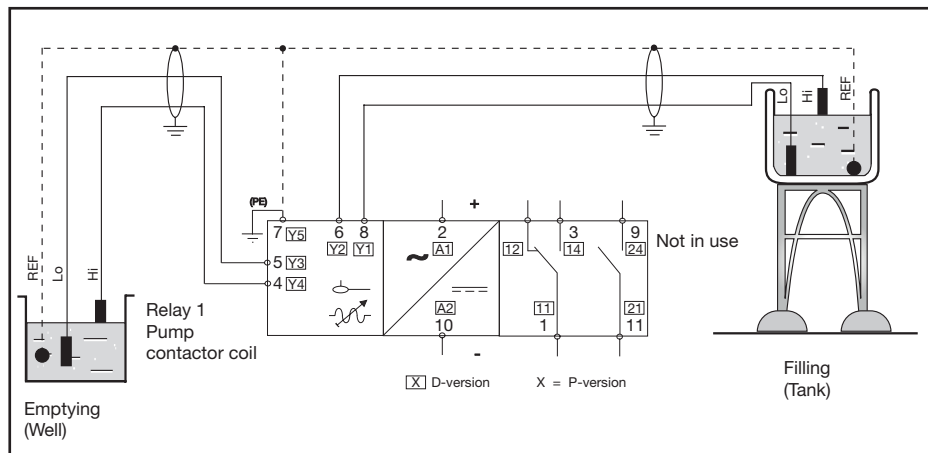

Tank-Well application (Filling and emptying)

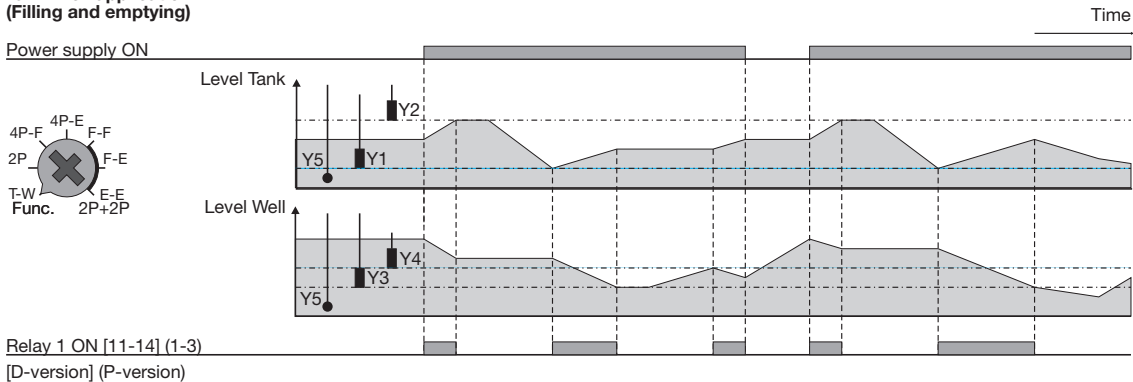

Operation Diagram

Function: Direct input- output
 The Multifunction Controller can be used as direct input/ output, where each of the two inputs (electrodes) controls an individual relay output:
 Electrode no. 1 = Relay no. 1
 Electrode no. 2 = Relay no. 2.

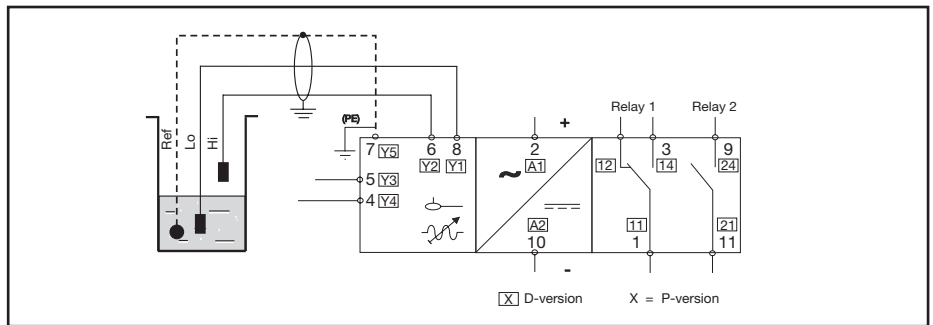

2-Probe (Direct Input to output)

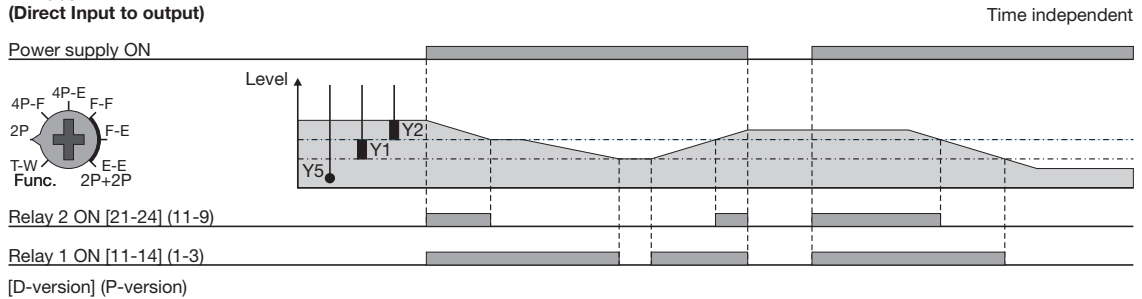

Function: Filling or Emptying with high and low alarms

The Multifunction Controller can be used as a minimum-maximum control filling or emptying system, with HiHi and LoLo Alarm output.

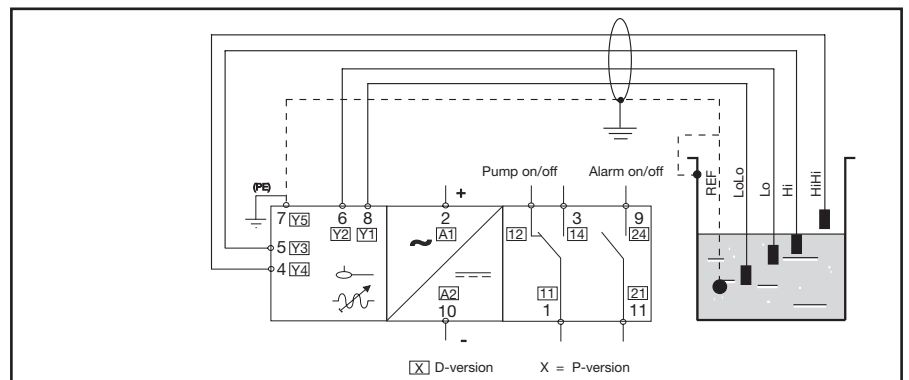

4-Probe Filling (Low and High alarm)

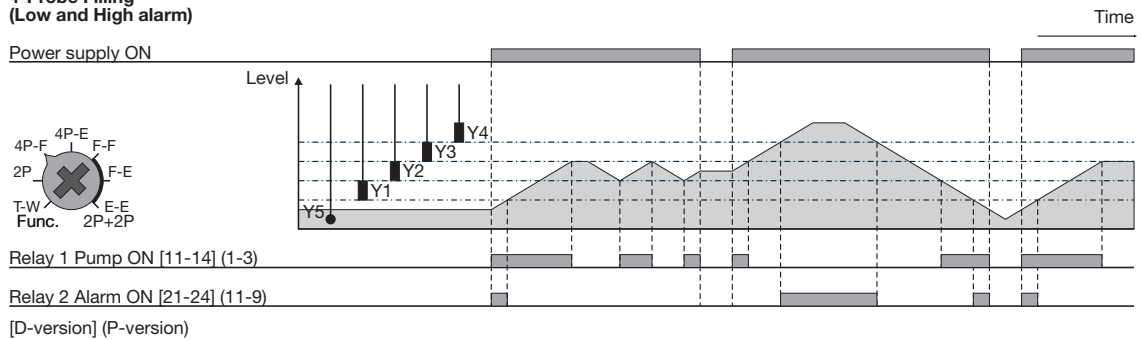

4-Probe Emptying (Low and High alarm)

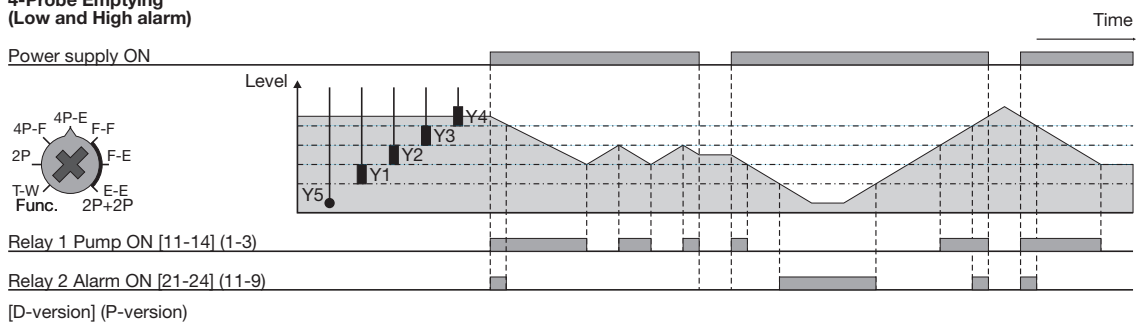

Operation Diagram

Function: Filling or Emptying
 The Multifunction Controller can be used as a minimum-maximum control for up to two individual systems, with the same kind of liquid to be measured.

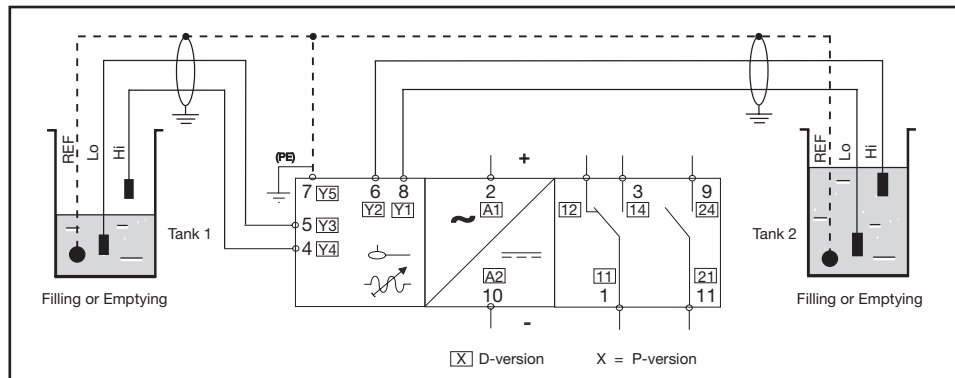

2 Individual systems (Filling and/or emptying)

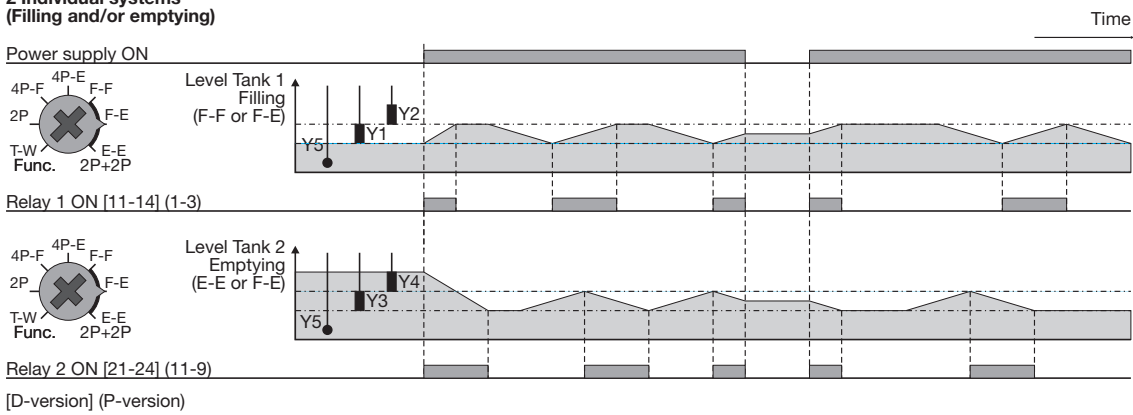

Wiring Diagram

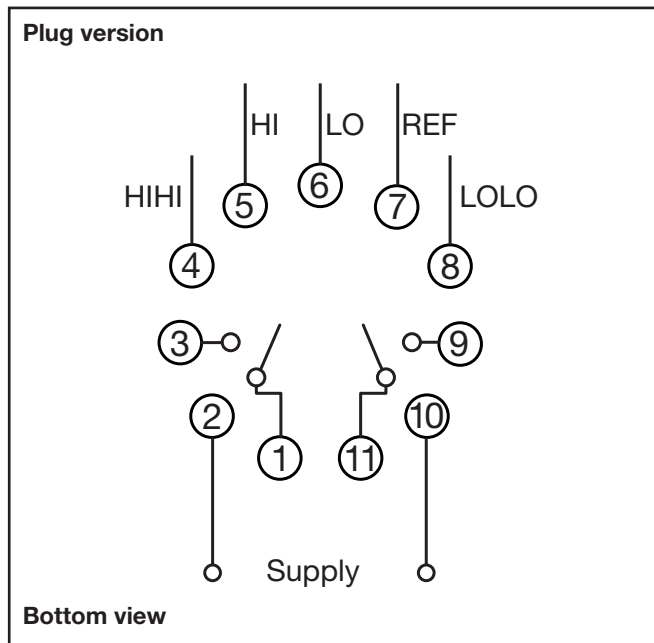
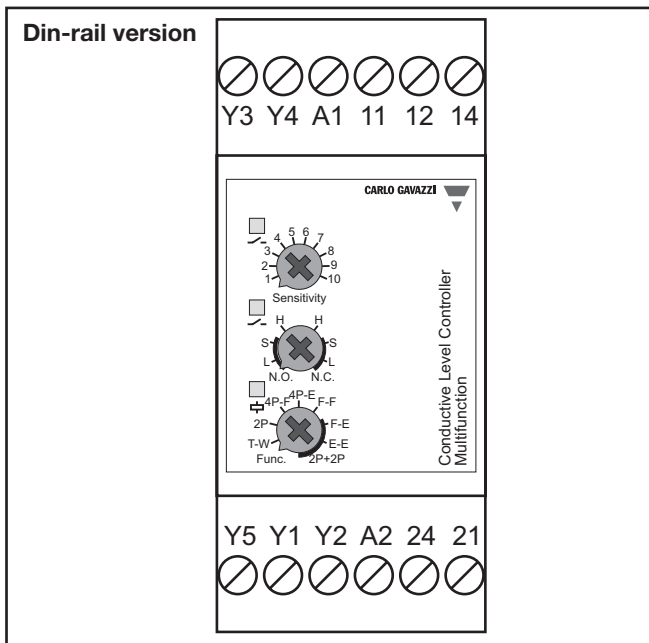

Dimension Drawings

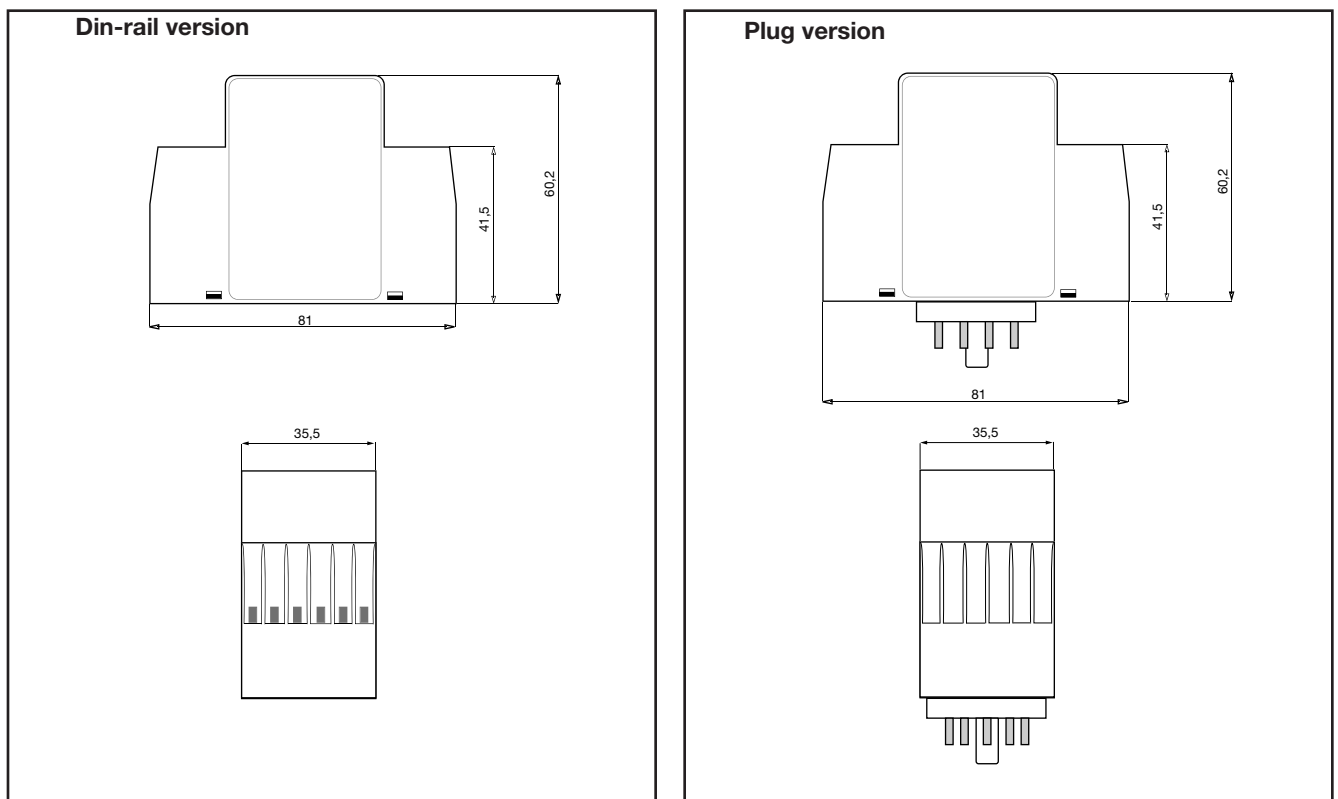

Accessories

- 11 pole circular socket ZPD11
- Retaining spring HF

Delivery Contents

- Amplifier
- Packaging: Carton box
- Manual