

*Phase leg
Series & parallel diodes
MOSFET Power Module*

$V_{DSS} = 200V$
 $R_{DSon} = 6m\Omega$ typ @ $T_j = 25^\circ C$
 $I_D = 300A$ @ $T_c = 25^\circ C$

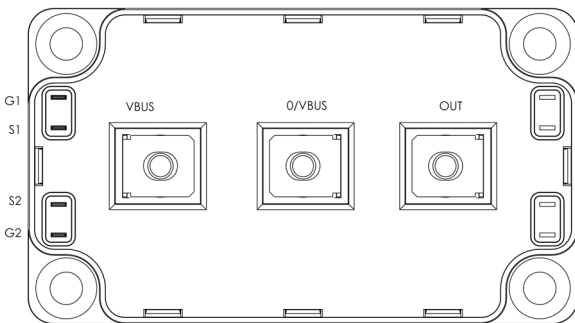
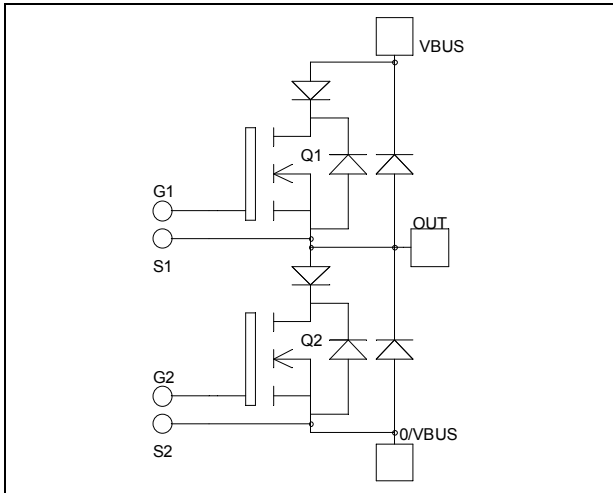

Application

- Motor control
- Switched Mode Power Supplies
- Uninterruptible Power Supplies

Features

- Power MOS 7[®] MOSFETs
 - Low R_{DSon}
 - Low input and Miller capacitance
 - Low gate charge
 - Fast intrinsic reverse diode
 - Avalanche energy rated
 - Very rugged
- Kelvin source for easy drive
- Very low stray inductance
 - Symmetrical design
 - M5 power connectors
- High level of integration

Benefits

- Outstanding performance at high frequency operation
- Direct mounting to heatsink (isolated package)
- Low junction to case thermal resistance
- Low profile
- RoHS Compliant

Absolute maximum ratings

Symbol	Parameter	Max ratings	Unit
V_{DSS}	Drain - Source Breakdown Voltage	200	V
I_D	Continuous Drain Current	$T_c = 25^\circ C$	300
		$T_c = 80^\circ C$	225
I_{DM}	Pulsed Drain current	1200	
V_{GS}	Gate - Source Voltage	± 30	V
R_{DSon}	Drain - Source ON Resistance	7.2	$m\Omega$
P_D	Maximum Power Dissipation	$T_c = 25^\circ C$	1250
I_{AR}	Avalanche current (repetitive and non repetitive)	24	A
E_{AR}	Repetitive Avalanche Energy	30	mJ
E_{AS}	Single Pulse Avalanche Energy	1300	

CAUTION: These Devices are sensitive to Electrostatic Discharge. Proper Handling Procedures Should Be Followed. See application note APT0502 on www.microsemi.com

All ratings @ $T_j = 25^\circ\text{C}$ unless otherwise specified

Electrical Characteristics

Symbol	Characteristic	Test Conditions	Min	Typ	Max	Unit
I_{DSS}	Zero Gate Voltage Drain Current	$V_{GS} = 0V, V_{DS} = 200V$			500	μA
		$V_{GS} = 0V, V_{DS} = 160V$	$T_j = 125^\circ\text{C}$		2000	
$R_{DS(on)}$	Drain – Source on Resistance	$V_{GS} = 10V, I_D = 150A$		6	7.2	$\text{m}\Omega$
$V_{GS(th)}$	Gate Threshold Voltage	$V_{GS} = V_{DS}, I_D = 6\text{mA}$	3		5	V
I_{GSS}	Gate – Source Leakage Current	$V_{GS} = \pm 30V, V_{DS} = 0V$			± 500	nA

Dynamic Characteristics

Symbol	Characteristic	Test Conditions	Min	Typ	Max	Unit
C_{iss}	Input Capacitance	$V_{GS} = 0V$		18.5		nF
C_{oss}	Output Capacitance	$V_{DS} = 25V$		6.03		
C_{rss}	Reverse Transfer Capacitance	$f = 1\text{MHz}$		0.58		
Q_g	Total gate Charge	$V_{GS} = 10V$ $V_{Bus} = 100V$ $I_D = 300A$		325		nC
Q_{gs}	Gate – Source Charge			144		
Q_{gd}	Gate – Drain Charge			156		
$T_{d(on)}$	Turn-on Delay Time	Inductive switching @ 125°C $V_{GS} = 15V$ $V_{Bus} = 133V$ $I_D = 300A$ $R_G = 0.8\Omega$		28		ns
T_r	Rise Time			56		
$T_{d(off)}$	Turn-off Delay Time			81		
T_f	Fall Time			99		
E_{on}	Turn-on Switching Energy	Inductive switching @ 25°C $V_{GS} = 15V, V_{Bus} = 133V$ $I_D = 300A, R_G = 0.8\Omega$		1543		μJ
E_{off}	Turn-off Switching Energy			1517		
E_{on}	Turn-on Switching Energy	Inductive switching @ 125°C $V_{GS} = 15V, V_{Bus} = 133V$ $I_D = 300A, R_G = 0.8\Omega$		2027		μJ
E_{off}	Turn-off Switching Energy			1770		

Series diode ratings and characteristics

Symbol	Characteristic	Test Conditions	Min	Typ	Max	Unit
V_{RRM}	Maximum Peak Repetitive Reverse Voltage		200			V
I_{RM}	Maximum Reverse Leakage Current	$V_R = 200V$	$T_j = 25^\circ\text{C}$		350	μA
			$T_j = 125^\circ\text{C}$		600	
I_F	DC Forward Current	$T_c = 85^\circ\text{C}$		120		A
V_F	Diode Forward Voltage	$I_F = 120A$		1.1	1.15	V
		$I_F = 240A$		1.4		
		$I_F = 120A$	$T_j = 125^\circ\text{C}$		0.9	
t_{rr}	Reverse Recovery Time	$I_F = 120A$ $V_R = 133V$ $di/dt = 400A/\mu\text{s}$	$T_j = 25^\circ\text{C}$		31	ns
			$T_j = 125^\circ\text{C}$		60	
Q_{rr}	Reverse Recovery Charge	$I_F = 120A$ $V_R = 133V$ $di/dt = 400A/\mu\text{s}$	$T_j = 25^\circ\text{C}$		120	nC
			$T_j = 125^\circ\text{C}$		500	

Parallel diode ratings and characteristics

<i>Symbol</i>	<i>Characteristic</i>	<i>Test Conditions</i>		<i>Min</i>	<i>Typ</i>	<i>Max</i>	<i>Unit</i>
V _{RRM}	Maximum Peak Repetitive Reverse Voltage			200			V
I _{RM}	Maximum Reverse Leakage Current	V _R =200V	T _j = 25°C			350	μA
			T _j = 125°C			600	
I _F	DC Forward Current	T _c = 85°C			120		A
V _F	Diode Forward Voltage	I _F = 120A			1.1	1.15	V
		I _F = 240A			1.4		
		I _F = 120A	T _j = 125°C		0.9		
t _{rr}	Reverse Recovery Time	I _F = 120A V _R = 133V di/dt = 400A/μs	T _j = 25°C		31		ns
			T _j = 125°C		60		
Q _{rr}	Reverse Recovery Charge	I _F = 120A V _R = 133V di/dt = 400A/μs	T _j = 25°C		120		nC
			T _j = 125°C		500		

Thermal and package characteristics

<i>Symbol</i>	<i>Characteristic</i>			<i>Min</i>	<i>Typ</i>	<i>Max</i>	<i>Unit</i>
R _{thJC}	Junction to Case Thermal Resistance	Transistor				0.10	°C/W
		Series diode				0.46	
		Diode parallel				0.46	
V _{ISOL}	RMS Isolation Voltage, any terminal to case t = 1 min, 50/60Hz			4000			V
T _J	Operating junction temperature range			-40		150	°C
T _{STG}	Storage Temperature Range			-40		125	
T _C	Operating Case Temperature			-40		100	
Torque	Mounting torque	To heatsink	M6	3		5	N.m
		For terminals	M5	2		3.5	
Wt	Package Weight					300	g

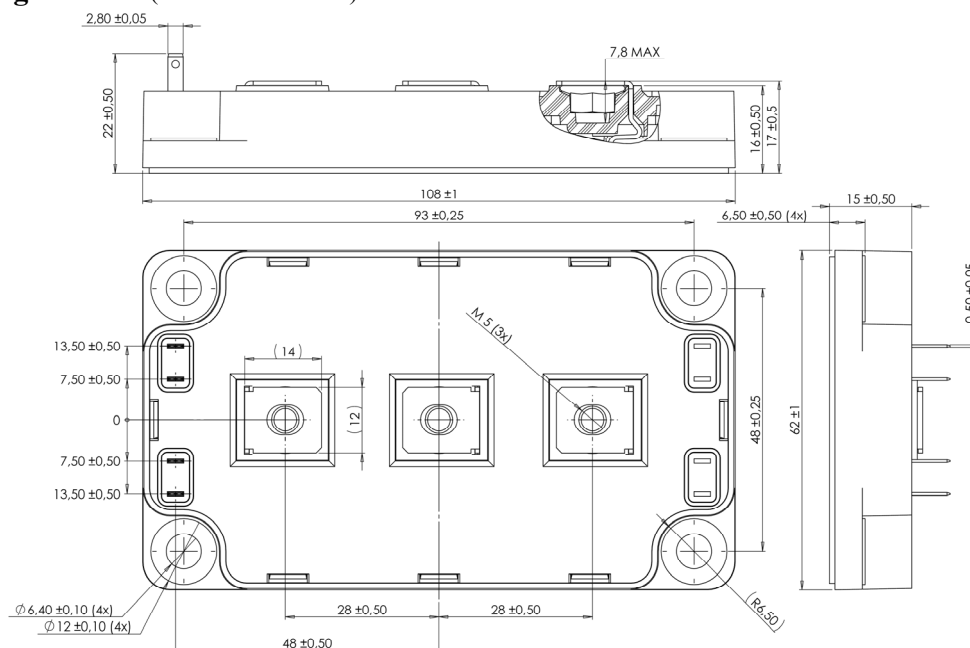
SP6 Package outline (dimensions in mm)

See application note APT0601 - Mounting Instructions for SP6 Power Modules on www.microsemi.com

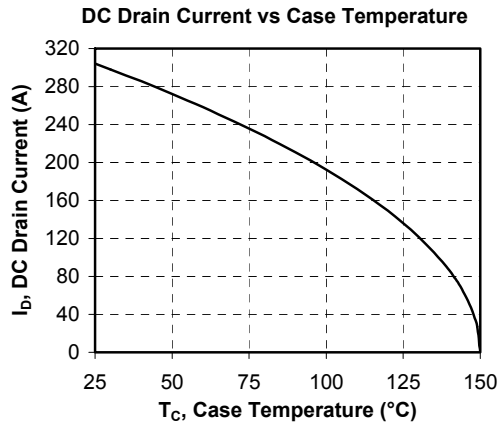
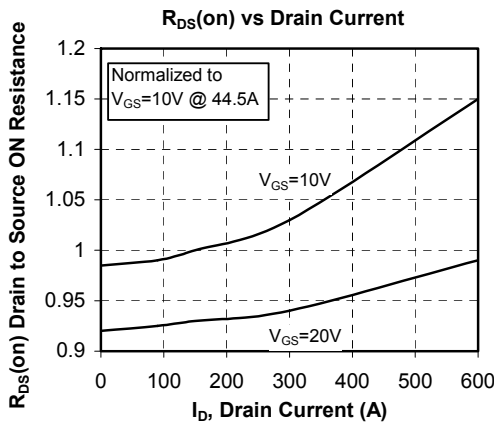
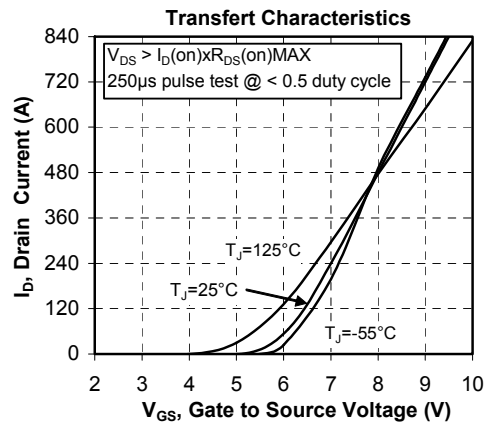
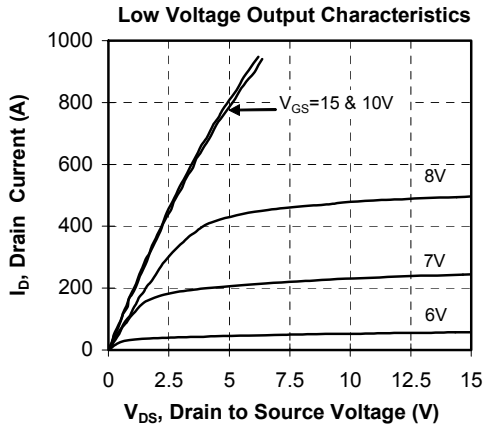
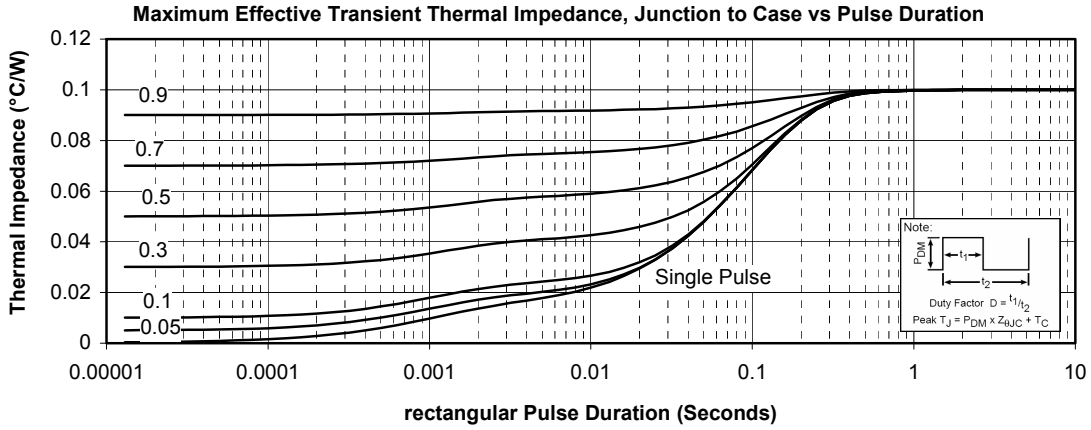
Typical Performance Curve

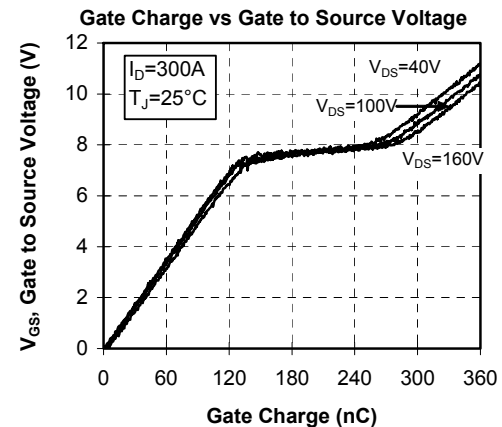
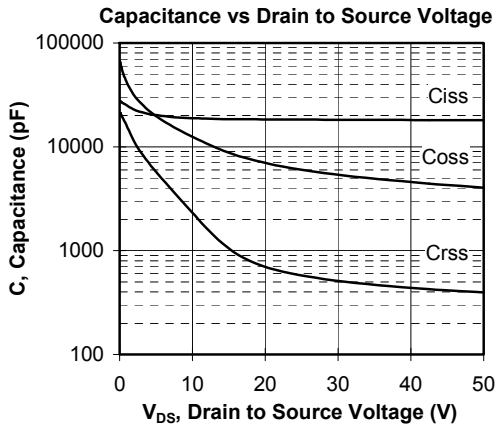
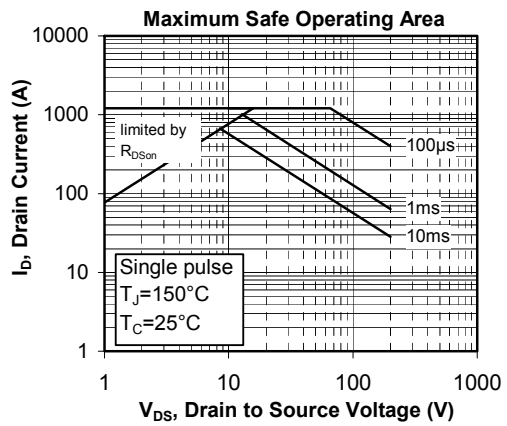
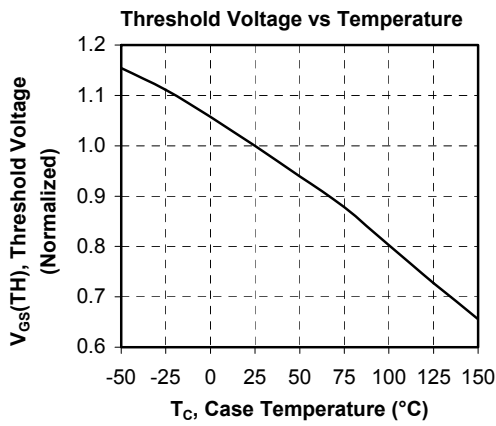
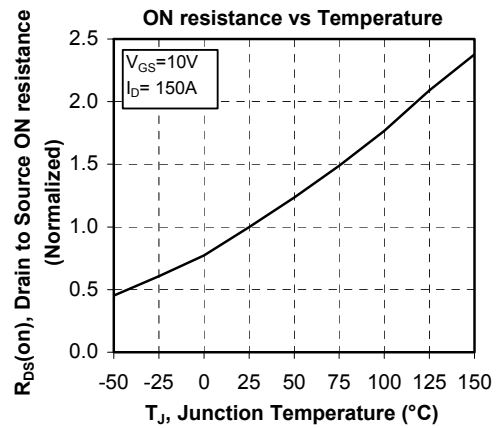
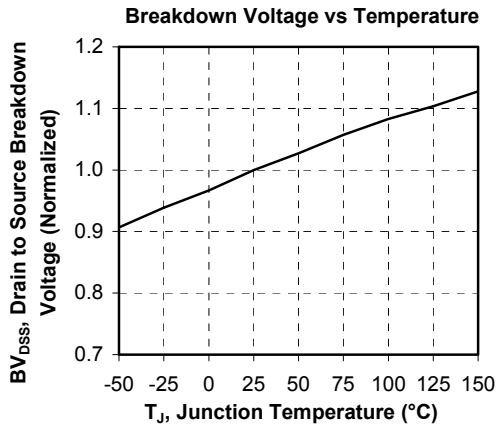

Delay Times vs Current

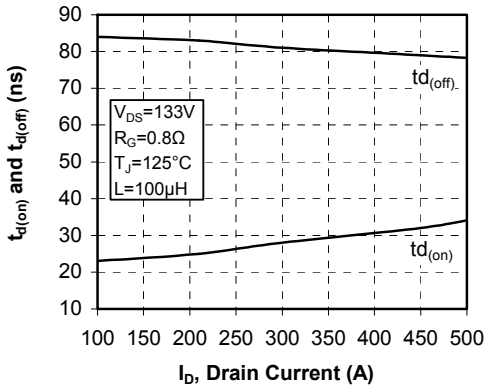

Rise and Fall times vs Current

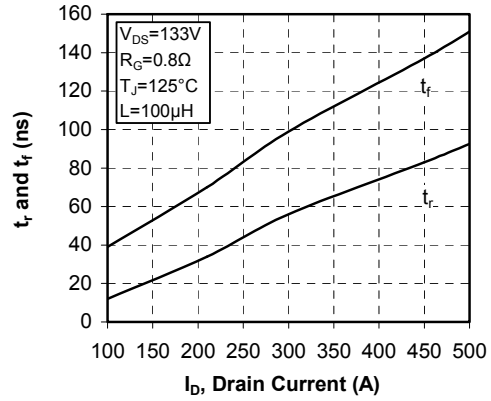

Switching Energy vs Current

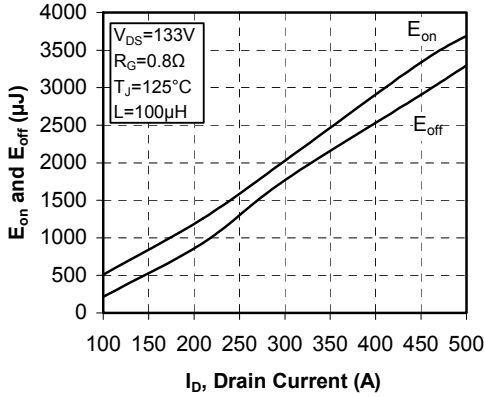

Switching Energy vs Gate Resistance

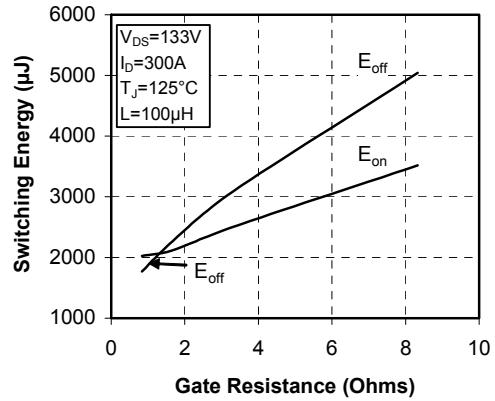

Operating Frequency vs Drain Current

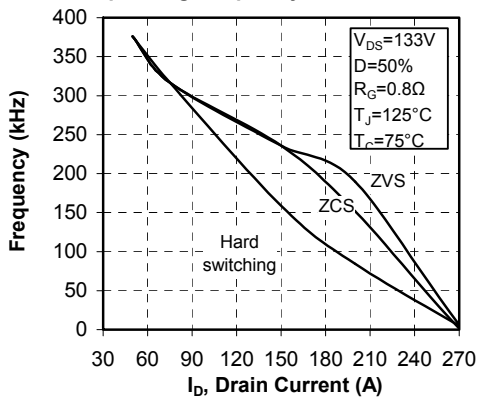

Source to Drain Diode Forward Voltage

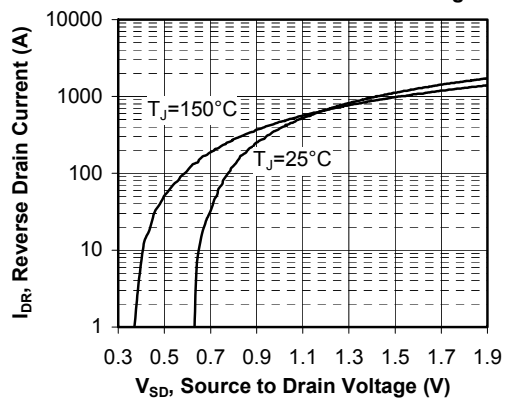

DISCLAIMER

The information contained in the document (unless it is publicly available on the Web without access restrictions) is PROPRIETARY AND CONFIDENTIAL information of Microsemi and cannot be copied, published, uploaded, posted, transmitted, distributed or disclosed or used without the express duly signed written consent of Microsemi. If the recipient of this document has entered into a disclosure agreement with Microsemi, then the terms of such Agreement will also apply. This document and the information contained herein may not be modified, by any person other than authorized personnel of Microsemi. No license under any patent, copyright, trade secret or other intellectual property right is granted to or conferred upon you by disclosure or delivery of the information, either expressly, by implication, inducement, estoppels or otherwise. Any license under such intellectual property rights must be approved by Microsemi in writing signed by an officer of Microsemi.

Microsemi reserves the right to change the configuration, functionality and performance of its products at anytime without any notice. This product has been subject to limited testing and should not be used in conjunction with life-support or other mission-critical equipment or applications. Microsemi assumes no liability whatsoever, and Microsemi disclaims any express or implied warranty, relating to sale and/or use of Microsemi products including liability or warranties relating to fitness for a particular purpose, merchantability, or infringement of any patent, copyright or other intellectual property right. Any performance specifications believed to be reliable but are not verified and customer or user must conduct and complete all performance and other testing of this product as well as any user or customers final application. User or customer shall not rely on any data and performance specifications or parameters provided by Microsemi. It is the customer's and user's responsibility to independently determine suitability of any Microsemi product and to test and verify the same. The information contained herein is provided "AS IS, WHERE IS" and with all faults, and the entire risk associated with such information is entirely with the User. Microsemi specifically disclaims any liability of any kind including for consequential, incidental and punitive damages as well as lost profit. The product is subject to other terms and conditions which can be located on the web at <http://www.microsemi.com/legal/tnc.asp>

Life Support Application

Seller's Products are not designed, intended, or authorized for use as components in systems intended for space, aviation, surgical implant into the body, in other applications intended to support or sustain life, or for any other application in which the failure of the Seller's Product could create a situation where personal injury, death or property damage or loss may occur (collectively "Life Support Applications").

Buyer agrees not to use Products in any Life Support Applications and to the extent it does it shall conduct extensive testing of the Product in such applications and further agrees to indemnify and hold Seller, and its officers, employees, subsidiaries, affiliates, agents, sales representatives and distributors harmless against all claims, costs, damages and expenses, and attorneys' fees and costs arising, directly or indirectly, out of any claims of personal injury, death, damage or otherwise associated with the use of the goods in Life Support Applications, even if such claim includes allegations that Seller was negligent regarding the design or manufacture of the goods.

Buyer must notify Seller in writing before using Seller's Products in Life Support Applications. Seller will study with Buyer alternative solutions to meet Buyer application specification based on Sellers sales conditions applicable for the new proposed specific part.