

# MAX15462C 12V Evaluation Kit

# Evaluates: MAX15462C in 12V Output Voltage Application

## General Description

The MAX15462C 12V evaluation kit (EV kit) is a fully assembled and tested circuit board that demonstrates the performance of the MAX15462C 42V, 300mA ultra-small, high-efficiency, synchronous step-down converter. The EV kit operates over a wide input voltage range of 14V to 42V, and provides up to 300mA load current at 12V output voltage. The device features undervoltage lockout, overcurrent protection, and thermal shutdown. The EV kit switches at a frequency of 500kHz, and delivers a peak efficiency of 95% with the supplied components.

The EV kit comes installed with the MAX15462CATA+ in an 8-pin (2mm x 2mm) lead(Pb)-free/RoHS-compliant TDFN package.

## Features and Benefits

- 14V to 42V Input Voltage Range
- 12V Output, 300mA Continuous Current
- Internal Compensation
- EN/UVLO for On/Off Control and Programmable Input Undervoltage Lockout
- 95% Peak Efficiency
- 500kHz Switching Frequency
- PFM or Forced-PWM Mode of Operation
- Hiccup Mode Overcurrent Protection
- Open-Drain  $\overline{\text{RESET}}$  Output
- Thermal Shutdown
- Lead-Free, 8-Pin, 2mm x 2mm TDFN Package
- Proven PCB Layout
- Fully Assembled and Tested

**Ordering Information** appears at end of data sheet.

## Quick Start

### Recommended Equipment

- MAX15462C 12V EV kit
- 42V adjustable, 0.5A DC power supply
- Electronic load up to 300mA
- Voltmeter

### Procedure

The EV kit is fully assembled and tested. Follow the steps below to verify board operation. **Caution: Do not turn on the power supply until all connections are completed.**

- 1) Verify that shunts are installed on jumpers JU1, JU2 (EN/UVLO).
- 2) Verify that jumper JU3 (MODE-PFM operation) is open.
- 3) Set the electronic load to constant-current mode, 300mA, and disable the electronic load.
- 4) Connect the electronic load's positive terminal to the VOUT PCB pad. Connect the negative terminal to the GND PCB pad.
- 5) Connect the voltmeter across the VOUT and GND PCB pads.
- 6) Set the power-supply output to 24V. Disable the power supply.
- 7) Connect the 24V power-supply output to the VIN PCB pad. Connect the supply ground to the GND PCB pad.
- 8) Turn on the power supply.
- 9) Enable the electronic load and verify that output voltage is at 12V with respect to GND.
- 10) Vary the input voltage from 14V to 42V.
- 11) Vary the load current from 1mA to 300mA and verify that output voltage is 12V.

**Detailed Description**

The MAX15462C 12V EV kit is a fully assembled and tested circuit board that demonstrates the performance of the MAX15462C 42V, 300mA ultra-small, high-efficiency, synchronous step-down converter. The EV kit operates over a wide input voltage range of 14V to 42V, and provides up to 300mA load current at 12V output voltage. The device features undervoltage lockout, overcurrent protection, and thermal shutdown. The EV kit switches at a frequency of 500kHz, and delivers a peak efficiency of 95% with the supplied components.

The EV kit includes an EN/UVLO PCB pad and jumpers JU1, JU2 to enable control of the converter output. The MODE PCB pad and jumper JU3 are provided for selecting the mode of operation of the converter. The VCC PCB pad helps measure the internal LDO voltage. An additional  $\overline{\text{RESET}}$  PCB pad is available for monitoring the open-drain logic output.

The EV kit output voltage can be configured to 15V by installing the resistor R6 and the inductor L1 (alternate) included in the EV kit.

**Enable Control (JU1, JU2)**

The EN/UVLO pin on the device serves as an on/off control while also allowing the user to program the input

undervoltage-lockout (UVLO) threshold. Jumpers JU1 and JU2 configure the EV kit’s output for turn-on/turn-off control. Install a shunt across jumper JU2 pins 1-2 to disable VOUT. See [Table 1](#) for proper JU1, JU2 jumper configurations.

Additionally, resistors R1 and R2 are included to set the UVLO to a desired turn-on voltage. Refer to the *Enable Input (EN/UVLO)*, *Soft-Start* section in the MAX15462 IC data sheet for additional information on setting the UVLO threshold voltage.

**Active-Low, Open-Drain Reset Output ( $\overline{\text{RESET}}$ )**

The EV kit provides a PCB pad to monitor the status of the  $\overline{\text{RESET}}$  output.  $\overline{\text{RESET}}$  goes high when  $V_{\text{OUT}}$  rises above 95% (typ) of its nominal regulated output voltage.  $\overline{\text{RESET}}$  goes low when  $V_{\text{OUT}}$  falls below 92% (typ) of its nominal regulated voltage.

**PFM or Forced-PWM Mode (MODE)**

The EV kit includes a jumper (JU3) to program the mode of operation of the converter. Install a shunt across JU3 before powering up the EV kit to enable the forced-PWM operation. Keep JU3 open to enable the light-load PFM operation. See [Table 2](#) for proper JU3 jumper configurations.

**Table 1. Enable Control (EN/UVLO) (JU1, JU2)**

SHUNT POSITION		EN/UVLO PIN	VOUT OUTPUT
JU1	JU2		
1-2	Open	Connected to VIN	Enabled
Open	1-2	Connected to GND	Disabled
1-2*	1-2*	Connected to midpoint of R1, R2 resistor-divider	Enabled at VIN ≥ 13V

\*Default position.

**Table 2. MODE Control**

SHUNT POSITION	MODE PIN	MODE OF OPERATION
1-2	Connected to GND	Forced PWM
Open*	Unconnected	PFM

\*Default position.

EV Kit Performance Report

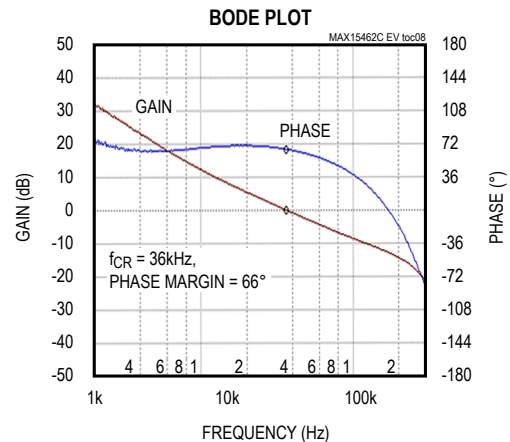
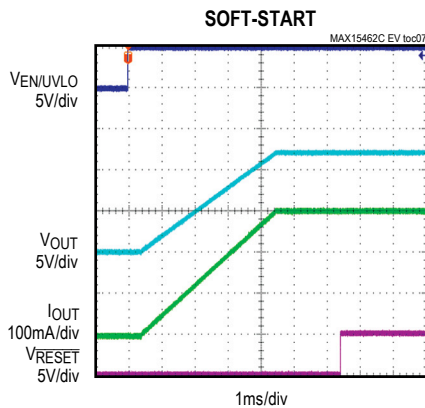
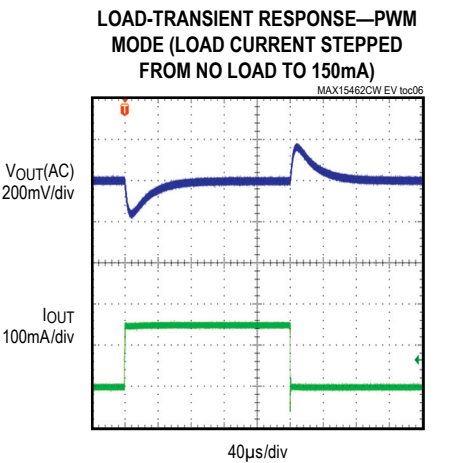
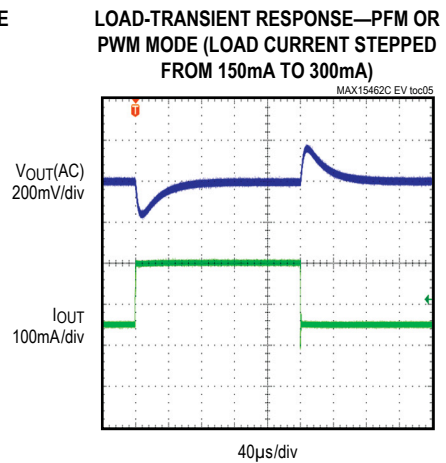
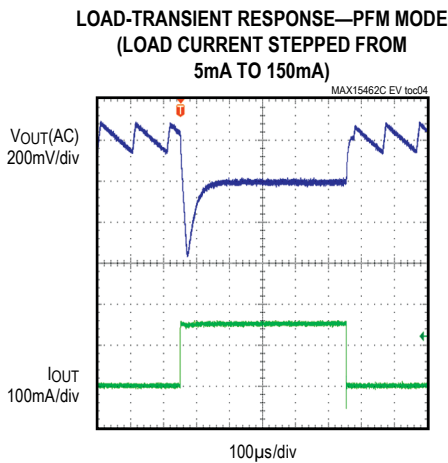
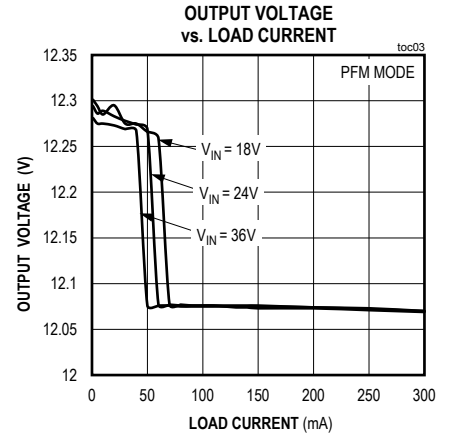
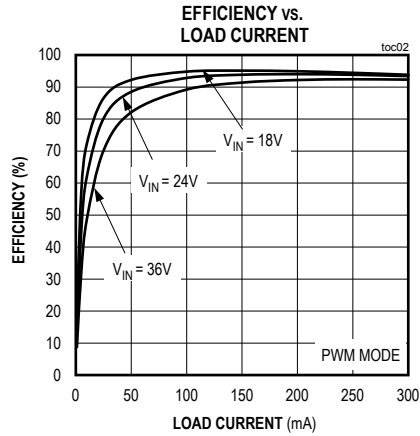
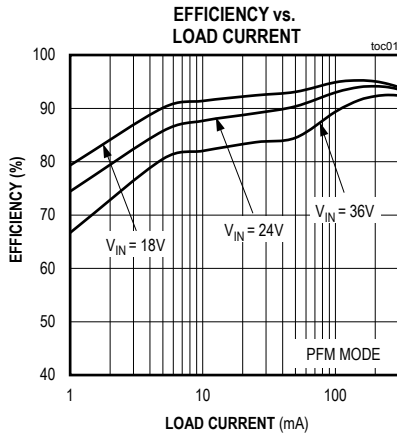

# MAX15462C 12V Evaluation Kit

# Evaluates: MAX15462C in 12V Output Voltage Application

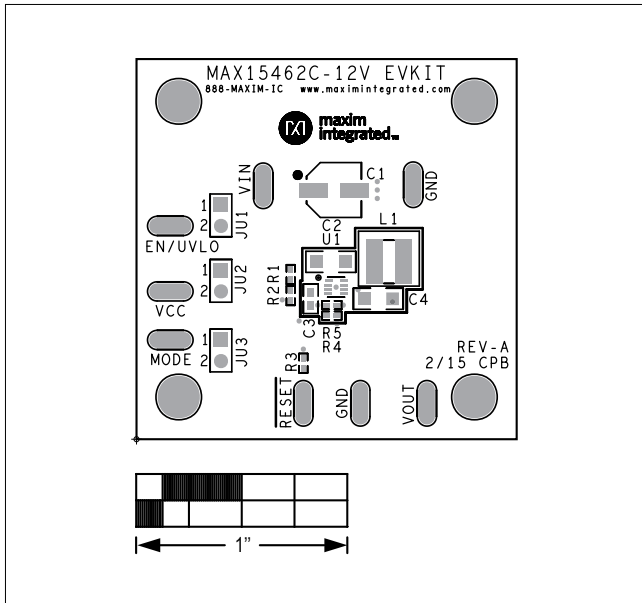

Figure 1. MAX15462C 12V EV Kit Component Placement Guide—Component Side

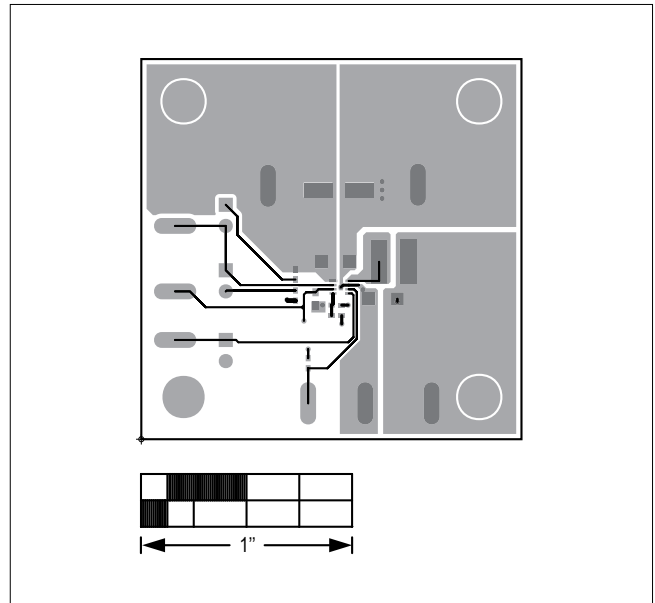

Figure 2. MAX15462C 12V EV Kit PCB Layout—Component Side

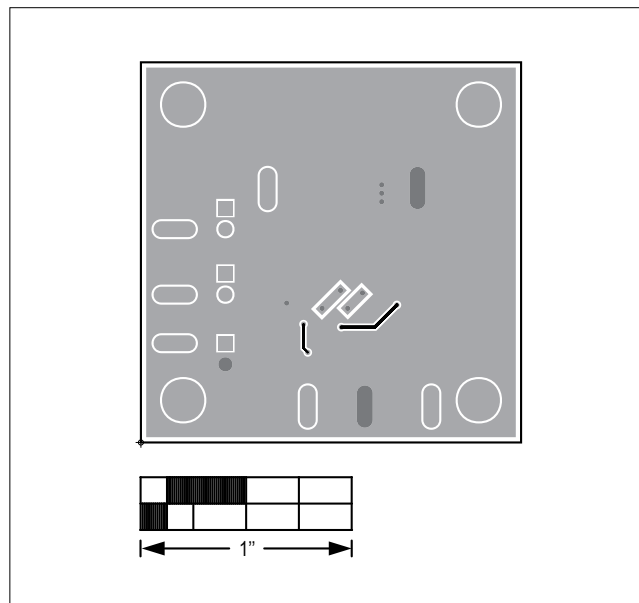

Figure 3. MAX15462C 12V EV Kit PCB Layout—Solder Side

## Component Suppliers

SUPPLIER	WEBSITE
Murata Americas	www.murata.com
Panasonic Corp.	www.panasonic.com
Würth Elektronik	www.we-online.com

**Note:** Indicate that you are using the MAX15462C when contacting these component suppliers.

## Component Information and Schematic

See the following links for component information and schematic:

- [MAX15462C EV BOM](#)
- [MAX15462C EV Schematic](#)

## Ordering Information

PART	TYPE
MAX15462C12EVKIT#	EV Kit

# Denotes RoHS compliant.

### Revision History

REVISION NUMBER	REVISION DATE	DESCRIPTION	PAGES CHANGED
0	03/15	Initial release	—

For pricing, delivery, and ordering information, please contact Maxim Direct at 1-888-629-4642, or visit Maxim Integrated's website at [www.maximintegrated.com](http://www.maximintegrated.com).

*Maxim Integrated cannot assume responsibility for use of any circuitry other than circuitry entirely embodied in a Maxim Integrated product. No circuit patent licenses are implied. Maxim Integrated reserves the right to change the circuitry and specifications without notice at any time.*

**BILL OF MATERIALS (BOM) Revision 3/15**

Description	Quantity	Designator	Part Number
22μF, 50V Electrolytic capacitors (6.6mm x 6.6mm case size)	1	C1	PANASONIC EEEFK1H220P
CAP+,1μF,10%,50V,X7R,1206	1	C2	MURATA GRM31MR71H105K
CAP+,1μF,10%,6.3V,X7R,0603	1	C3	MURATA GRM188R70J105K
CAP+,4.7μF,10%,16V,X7R,1206	1	C4	MURATA GRM31CR71C475K
INDUCTOR,100μH,620mA,	1	L1	Würth 74408943101
RES+,2.20MΩ,1%,0402	1	R1	
RES+,226KΩ,1%,0402	1	R2	
RES+,100KΩ,1%,0402	1	R3	
RES+,499KΩ,1%,0402	1	R4	
RES+,40.2KΩ,1%,0402	1	R5	
42V, 300mA, High Efficiency, Integrated MOSFET, Synchronous Step-Down Regulator (8 TDFN)	1	U1	MAXIM MAX15462CATA+
2 Pin Headers(0.1in centers)	3	JU1, JU2, JU3	

Jumper Table	
JUMPER	SHUNT POSITION
JU1	1,2 SHORT
JU2	1,2 SHORT
JU3	Connected to Pin1 only

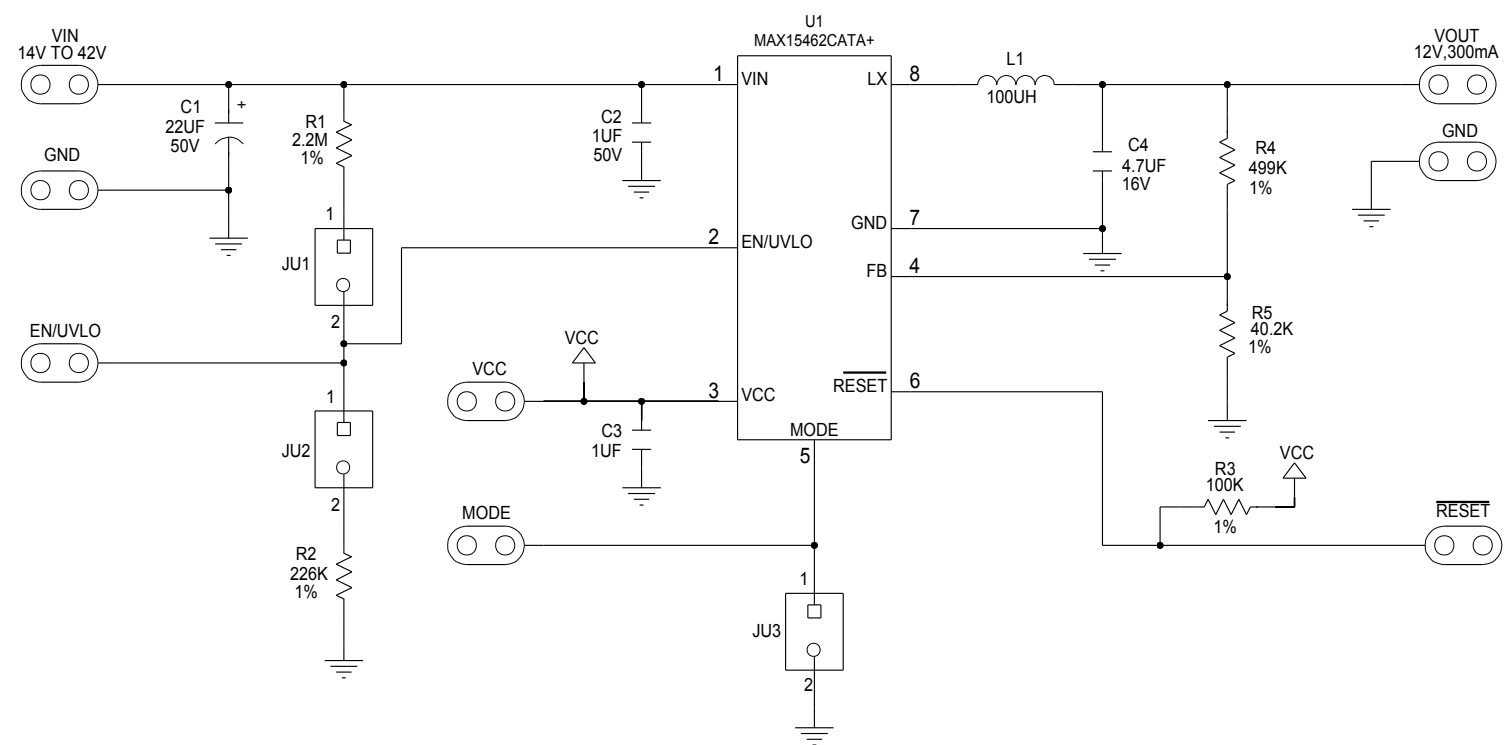

PROJECT TITLE: <b>MAX15462C12_EVKIT</b>		
DRAWING TITLE:		
SIZE <b>B</b>	HARDWARE NUMBER: <>	DATE: 02/25/2015
ENGINEER:	DRAWN BY:	REV: A
	TEMPLATE REV: B	SHEET 2 OF 2