

SPECIFICATION

- Part No. : **MA413.A.B.004**
- Product Name : MA413 Storm LTE Screw Mount Antenna
- Features : LTE 698 to 960MHz/1710 to 2170MHz/
2490 to 2690MHz Antenna
Screw-Mount [Permanent Mount]
Worldwide 4G Bands including 3G and 2G
Aerodynamic, Super Low-profile Vandal Resistant Housing
IP67 Enclosure
Dims: 216.24*93.25*30.95mm
5M CFD-200 with SMA(M) Connector
Custom Cables and Connectors Available
Product conforms to the EMC directive 2014/30/EU
RoHS Compliant



1. Introduction

The Storm MA413 antenna is a low profile, heavy-duty, fully IP67 waterproof external M2M antenna for use in worldwide telematics applications which combine Global Cellular communications. The MA413 delivers best in class LTE antenna performance. You will never be out of touch with this extremely robust antenna.

At only 31mm high, the Storm is the world's lowest profile global telematics antenna solution. It delivers powerful worldwide 4G LTE antenna technology while also covering the 3G and 2G bands.

Typical applications:

- Telematics
- HD Video over LTE
- First Responder and Emergency Services
- Internet of Things (IoT market)
- Wireless LTE M2M Devices
- Digital Signage

LTE 4G applications demand high speed data uplink and downlink. The MA413 does not require a ground plane. Low loss cables are used to keep efficiency high over long cable lengths.

Conformity is declared under the following standard: **EN55022 Class B**

This is to declare that the product listed above conforms to the EMC directive 2014/30/EU.

Cable length and connector types are customizable. Contact your regional Taoglas sales office for support.

2. Specification

4G/3G/2G LTE Antenna									
Frequency (MHz)	LTE700	GSM850	GSM900	DCS	PCS	UMTS1	LTE2600	LTE3500	
	698~803	824~894	880~960	1710~1880	1850~1990	1920~2170	2490~2690	3300~3600	
Efficiency (%)									
On the 50*50cm ground plane	30cm	62.06	41.76	49.16	44.93	59.56	59.39	55.42	37.39
	1M	59.27	39.88	46.95	40.98	54.46	54.71	50.55	33.33
	2M	55.31	36.93	42.81	36.86	48.53	48.56	43.53	27.99
	3M	51.62	34.20	39.76	32.65	42.73	42.47	36.84	23.59
	5M	44.25	28.85	33.36	25.50	32.98	32.90	28.22	16.96
In free space	30cm	65.08	48.08	55.44	49.41	57.62	59.92	54.98	38.19
	1M	62.15	45.91	52.95	45.06	52.69	55.18	50.14	34.83
	2M	58.00	42.54	48.29	40.62	46.96	48.99	43.17	29.65
	3M	54.13	39.46	44.80	35.92	41.31	42.84	36.53	24.66
	5M	46.39	33.24	37.60	28.10	31.89	33.19	27.99	19.14
Average Gain(dBi)									
On the 50*50cm ground plane	30cm	-2.22	-3.98	-3.20	-3.55	-2.27	-2.27	-2.57	-4.36
	1M	-2.42	-4.18	-3.40	-3.95	-2.66	-2.63	-2.97	-4.86
	2M	-2.72	-4.51	-3.80	-4.40	-3.16	-3.14	-3.62	-5.61
	3M	-3.02	-4.84	-4.13	-4.94	-3.72	-3.73	-4.35	-6.36
	5M	-3.70	-5.58	-4.88	-6.00	-4.84	-4.84	-5.50	-7.79
In free space	30cm	-2.02	-3.19	-2.60	-3.11	-2.42	-2.23	-2.62	-4.25
	1M	-2.22	-3.39	-2.80	-3.51	-2.81	-2.59	-3.02	-4.65
	2M	-2.52	-3.72	-3.20	-3.97	-3.31	-3.10	-3.67	-5.35
	3M	-2.82	-4.05	-3.52	-4.50	-3.86	-3.69	-4.39	-6.15
	5M	-3.50	-4.79	-4.28	-5.57	-4.98	-4.80	-5.55	-7.25
Peak Gain(dBi)									
On the 50*50cm ground plane	30cm	5.37	3.66	4.35	6.24	7.04	7.11	7.91	6.46
	1M	5.17	3.46	4.15	5.84	6.64	6.81	7.51	5.96
	2M	4.87	3.06	3.75	5.34	6.14	6.31	6.91	5.16
	3M	4.57	2.76	3.45	4.84	5.64	5.71	6.21	4.46
	5M	3.87	2.06	2.65	3.74	4.44	4.61	5.11	4.82
In free space	30cm	3.54	4.07	4.13	4.67	6.57	6.69	8.11	6.27
	1M	3.34	3.87	3.93	4.27	6.17	6.35	7.71	5.87
	2M	3.04	3.47	3.53	3.77	5.67	5.79	7.11	5.17
	3M	2.74	3.17	3.23	3.27	5.07	5.19	6.41	4.37
	5M	2.04	2.37	2.43	2.17	3.97	4.09	5.31	3.27
Impedance			50Ω						
Polarization			Linear						
VSWR			< 3						
Cable			5 meters CFD200 standard, fully customizable						
Connector			SMA Male connector, fully customizable						

MECHANICAL

Antenna Dimensions	216.24*93.25*30.95mm
Casing	ABS+PC
Base and thread	Nickel Plated Aluminum
Weight (including cable)	540g
Ingress Protection Rating	IP67
Maximum Assembly Torque	39.2 N-m

ENVIRONMENTAL

Operation Temperature	-40°C to 85°C
Storage Temperature	-40°C to 90°C
Humidity	Non-condensing 65°C 95% RH

LTE BANDS			
Band Number	LTE/ LTE-Advanced / WCDMA / HSPA / HSPA+ / TD-SCDMA		
	Uplink	Downlink	Covered
1	UL: 1920 to 1980	DL: 2110 to 2170	✓
2	UL: 1850 to 1910	DL: 1930 to 1990	✓
3	UL: 1710 to 1785	DL: 1805 to 1880	✓
4	UL: 1710 to 1755	DL: 2110 to 2155	✓
5	UL: 824 to 849	DL: 869 to 894	✓
7	UL: 2500 to 2570	DL: 2620 to 2690	✓
8	UL: 880 to 915	DL: 925 to 960	✓
9	UL: 1749.9 to 1784.9	DL: 1844.9 to 1879.9	✓
11	UL: 1427.9 to 1447.9	DL: 1475.9 to 1495.9	✗
12	UL: 699 to 716	DL: 729 to 746	✓
13	UL: 777 to 787	DL: 746 to 756	✓
14	UL: 788 to 798	DL: 758 to 768	✓
17	UL: 704 to 716	DL: 734 to 746 (LTE only)	✓
18	UL: 815 to 830	DL: 860 to 875 (LTE only)	✓
19	UL: 830 to 845	DL: 875 to 890	✓
20	UL: 832 to 862	DL: 791 to 821	✓
21	UL: 1447.9 to 1462.9	DL: 1495.9 to 1510.9	✗
22	UL: 3410 to 3490	DL: 3510 to 3590	✗
23	UL: 2000 to 2020	DL: 2180 to 2200 (LTE only)	✓
24	UL: 1625.5 to 1660.5	DL: 1525 to 1559 (LTE only)	✗
25	UL: 1850 to 1915	DL: 1930 to 1995	✓
26	UL: 814 to 849	DL: 859 to 894	✓
27	UL: 807 to 824	DL: 852 to 869 (LTE only)	✓
28	UL: 703 to 748	DL: 758 to 803 (LTE only)	✓
29	UL: -	DL: 717 to 728 (LTE only)	✓
30	UL: 2305 to 2315	DL: 2350 to 2360 (LTE only)	✓
31	UL: 452.5 to 457.5	DL: 462.5 to 467.5 (LTE only)	✗
32	UL: -	DL: 1452 - 1496	✗
35		1850 to 1910	✓
38		2570 to 2620	✓
39		1880 to 1920	✓
40		2300 to 2400	✓
41		2496 to 2690	✓
42		3400 to 3600	✗
43		3600 to 3800	✗

*Covered bands represent an efficiency greater than 20%

3. Antenna Characteristics

3.1 LTE Antenna

3.1.1 Test Setup

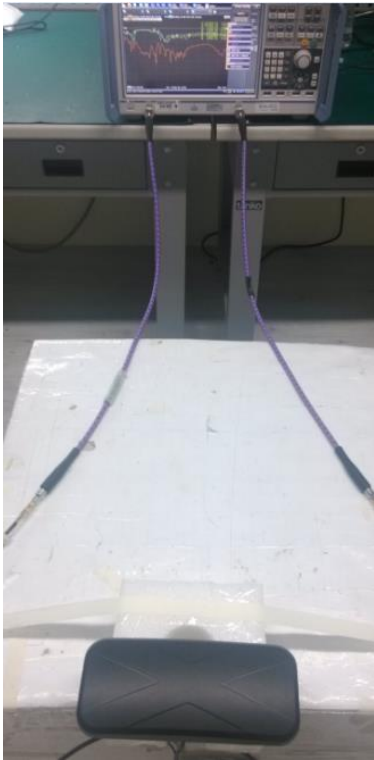

In free space

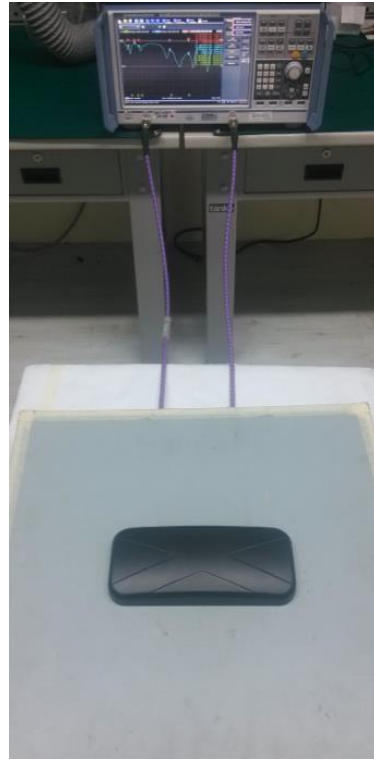

On the 50*50cm ground plane

3.1.2 LTE Antenna Return Loss and Isolation

Setup on 50*50cm ground plane with 5 meters cable length

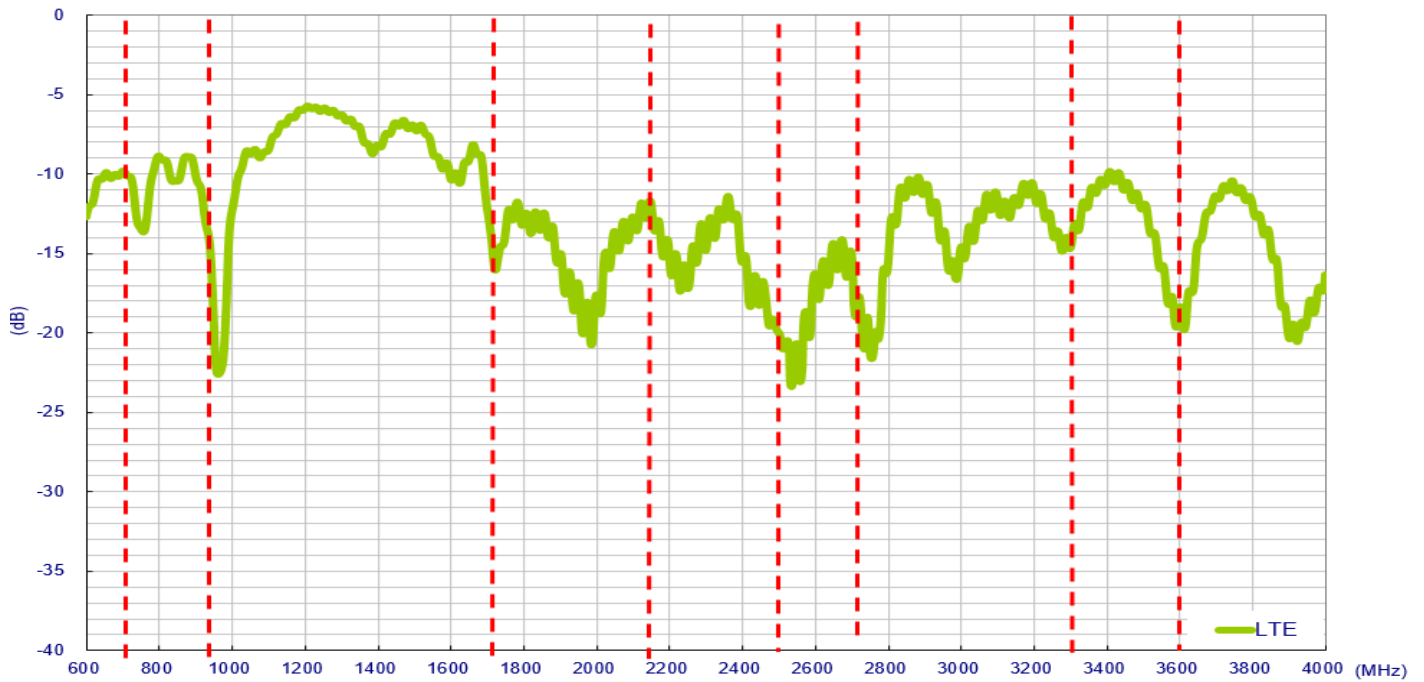

Setup in free space with 5 meters cable length

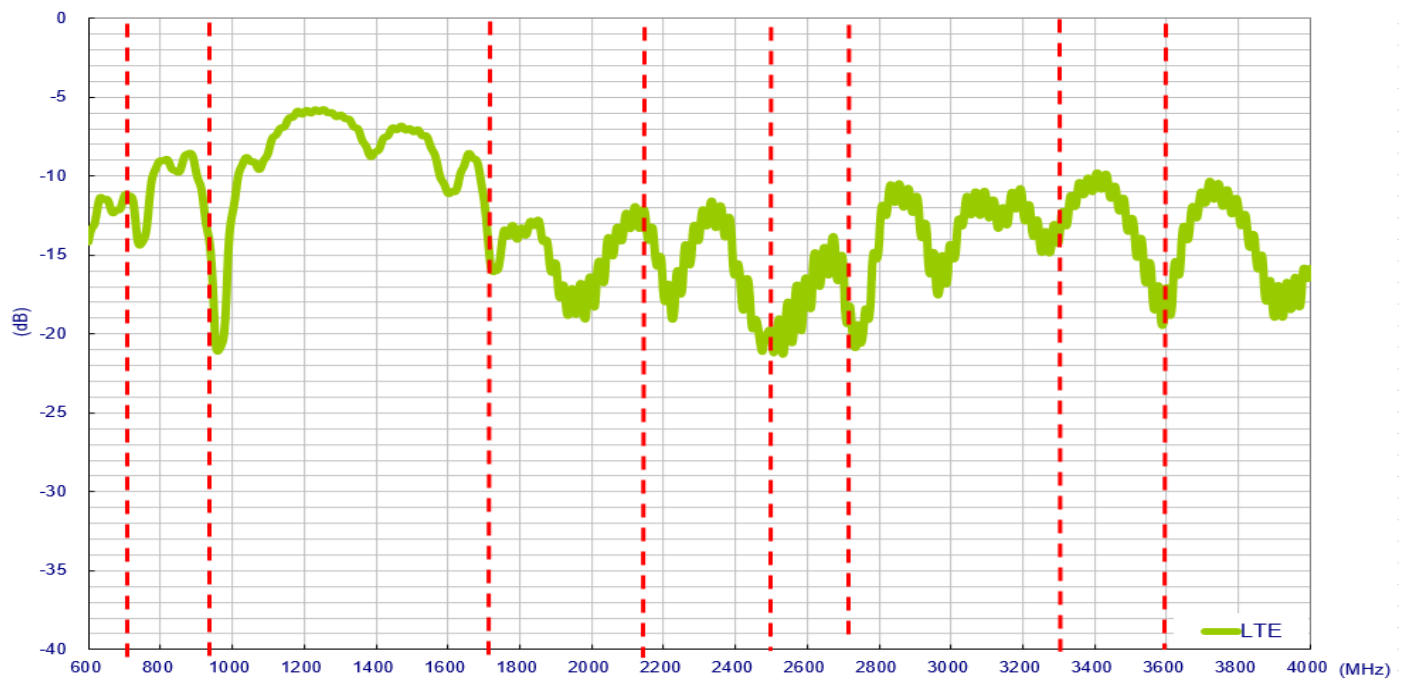

3.1.3 LTE Antenna Efficiency

Setup on 50*50cm ground plane with 5 meters cable length

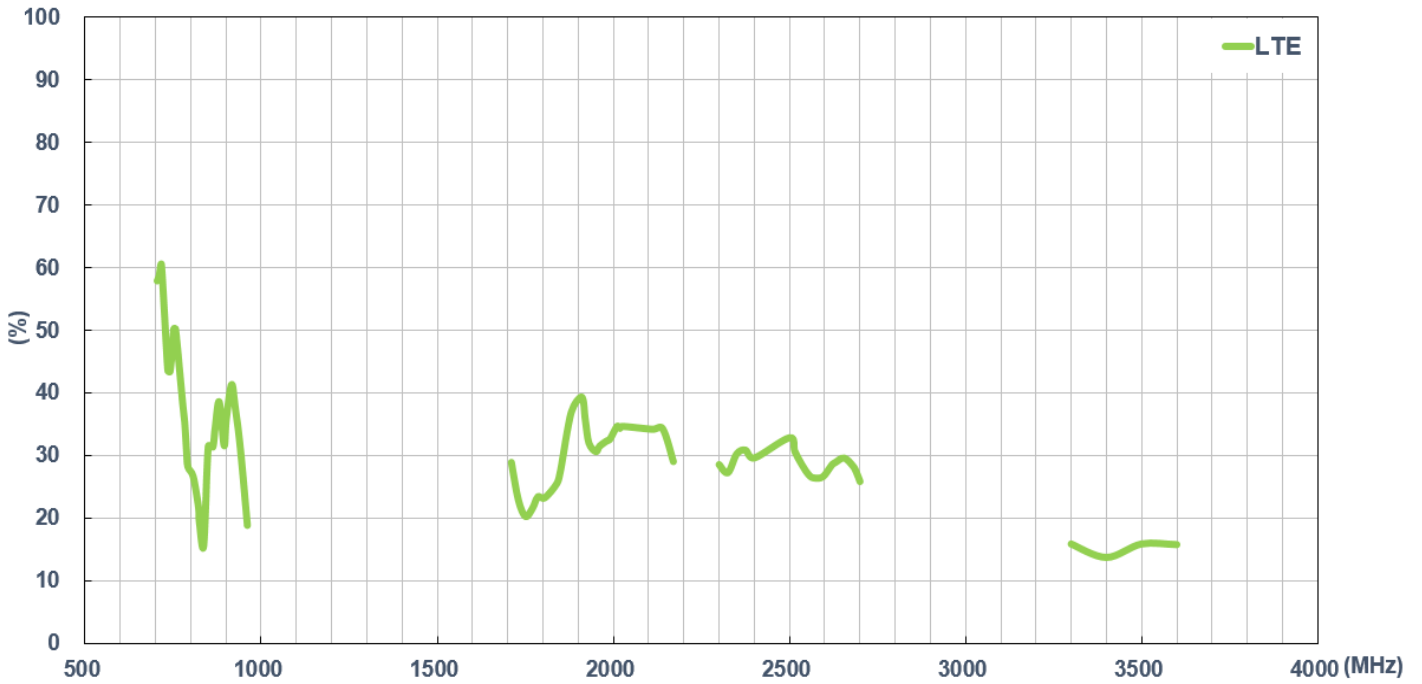

Setup in free space with 5 meters cable length

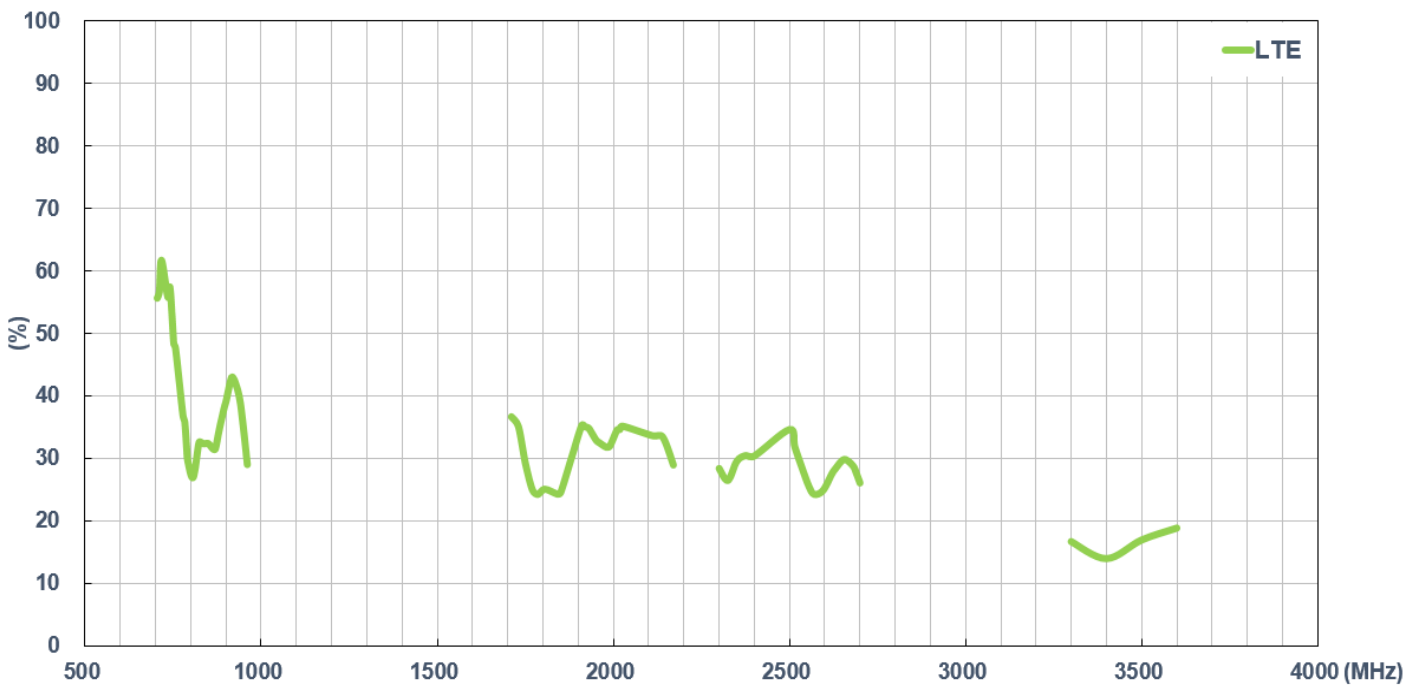

3.1.4 LTE Antenna Peak Gain

Setup on 50*50cm ground plane with 5 meters cable length

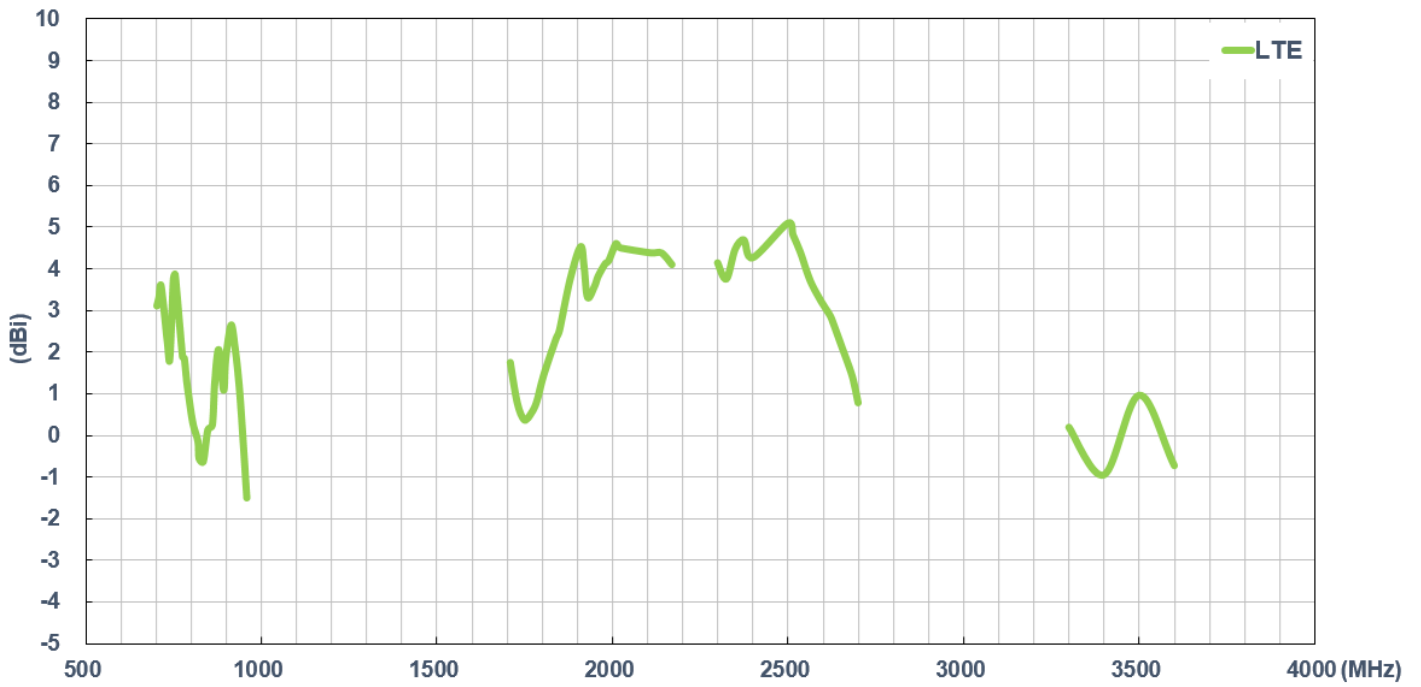

Setup in free space with 5 meters cable length

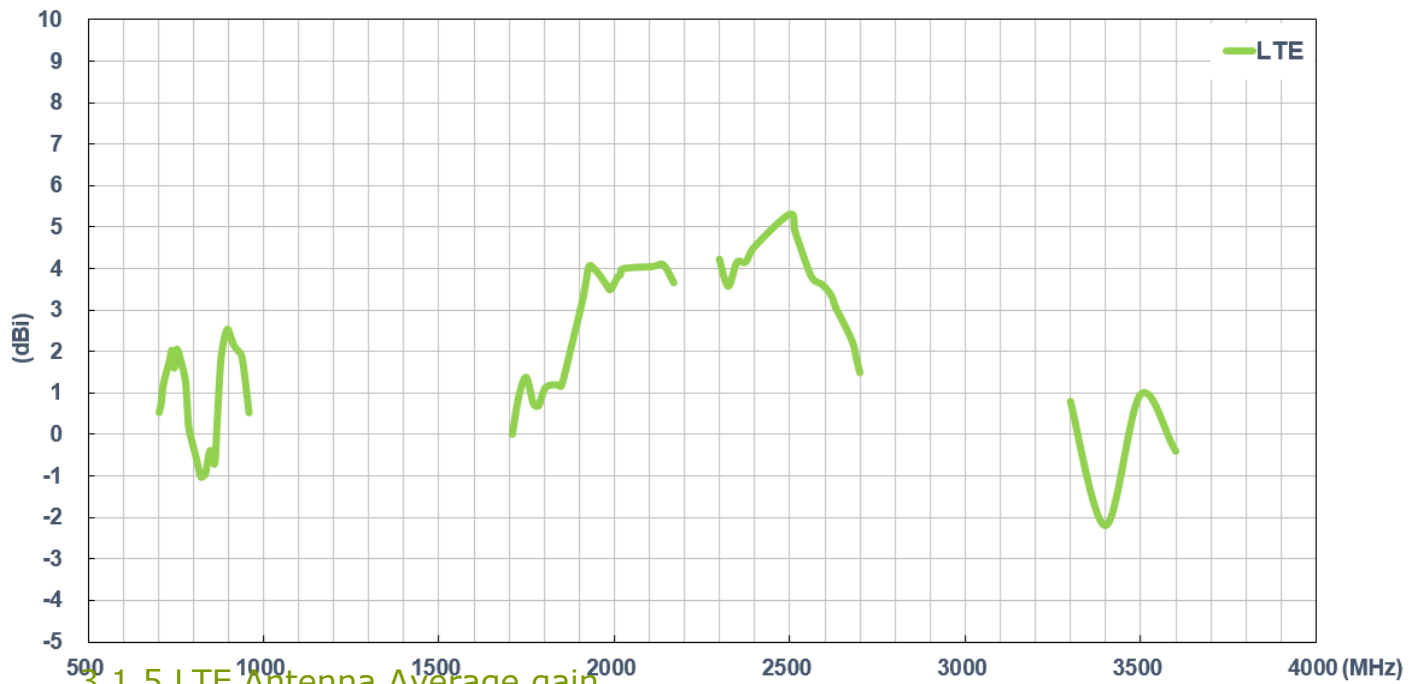

3.1.5 LTE Antenna Average gain

Setup on 50*50cm ground plane with 5 meters cable length

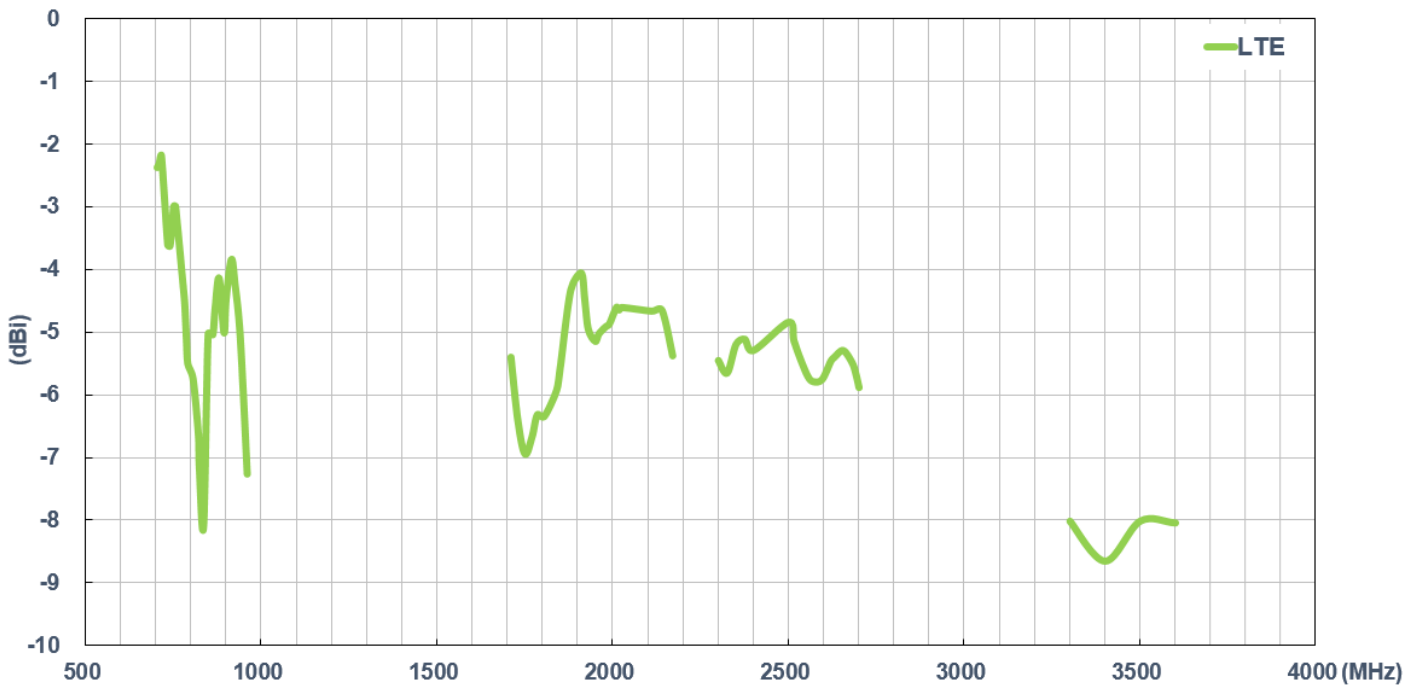

Setup in free space with 5 meters cable length

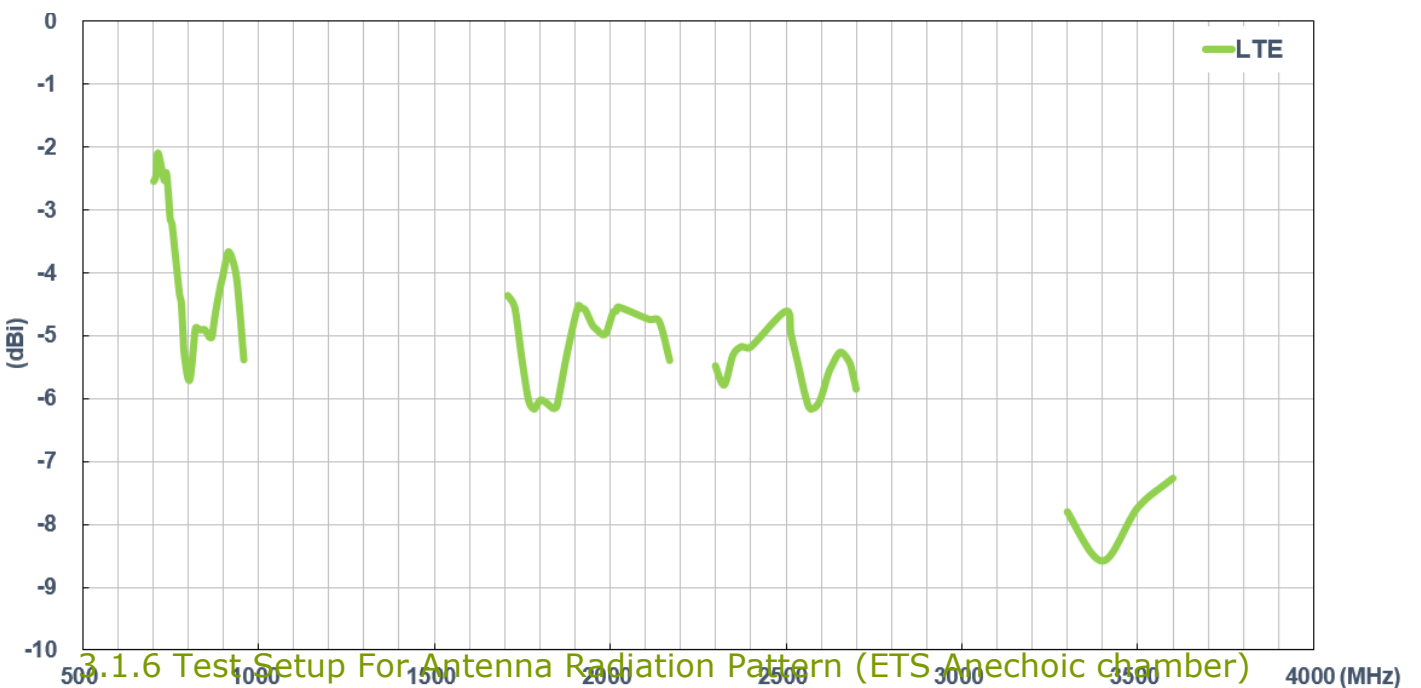

3.1.6 Test Setup For Antenna Radiation Pattern (ETS Anechoic chamber)

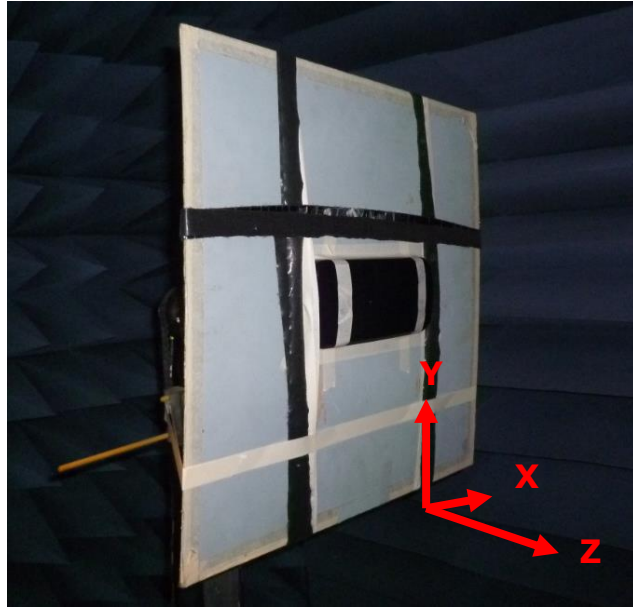

On 50*50cm ground plane

3.1.7 2D Radiation pattern (LTE with 5M cable length on the 50*50 ground plane)

XY Plane

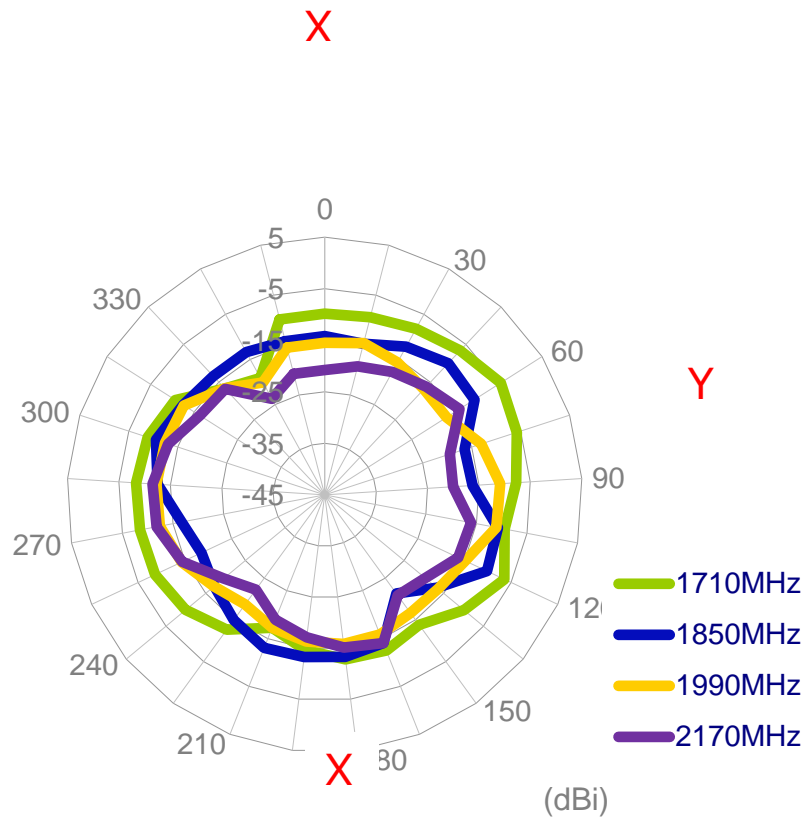
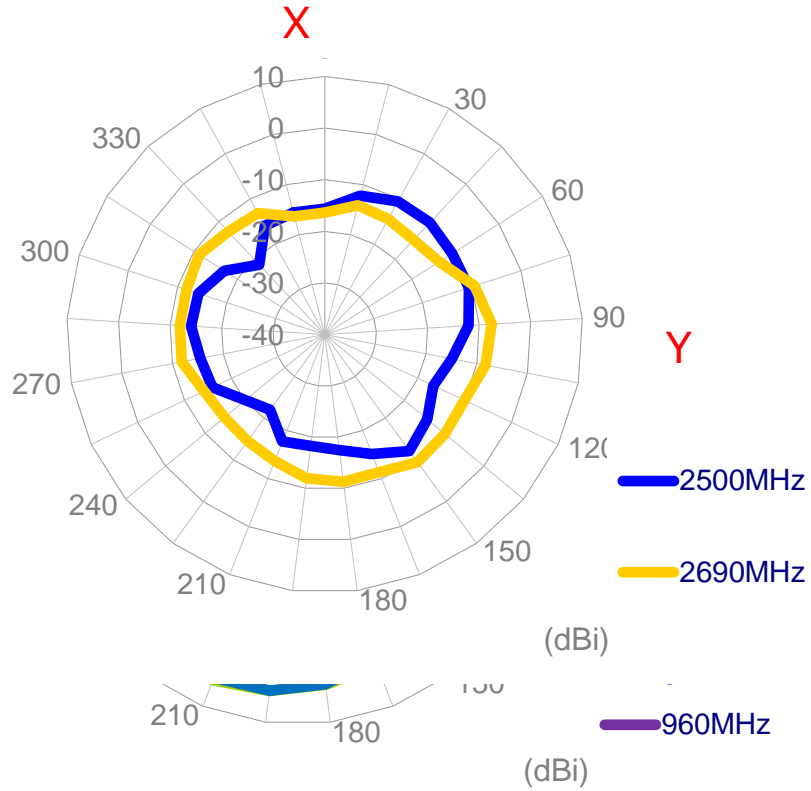

Y

X

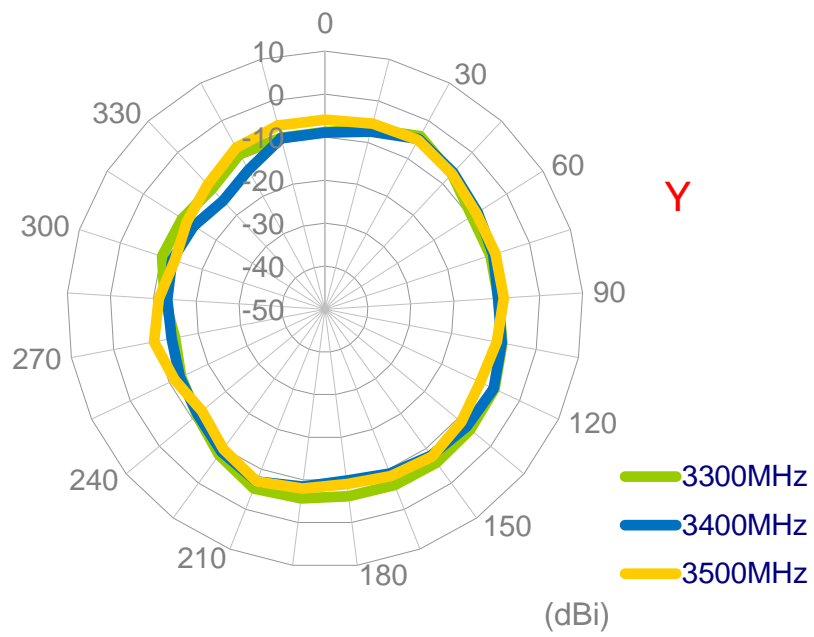

XZ Plane

Z

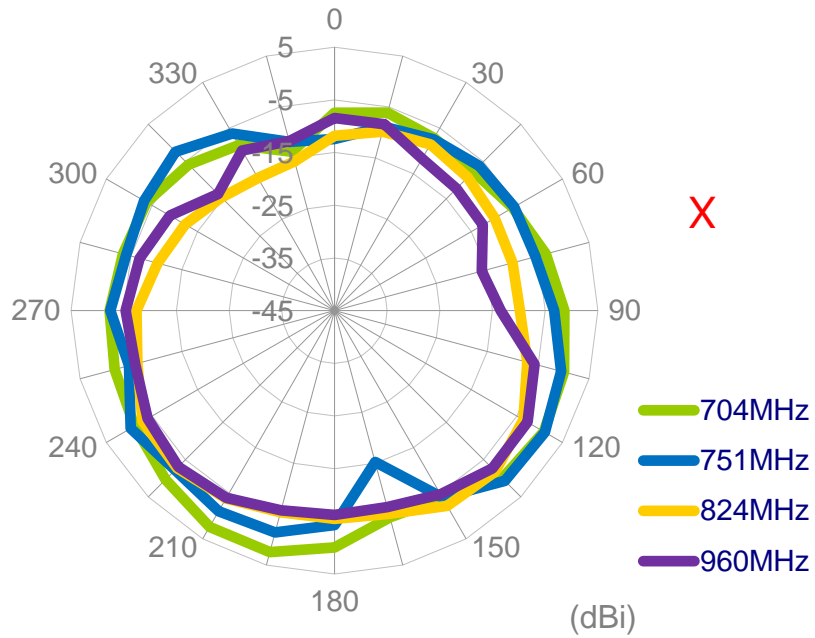

Z

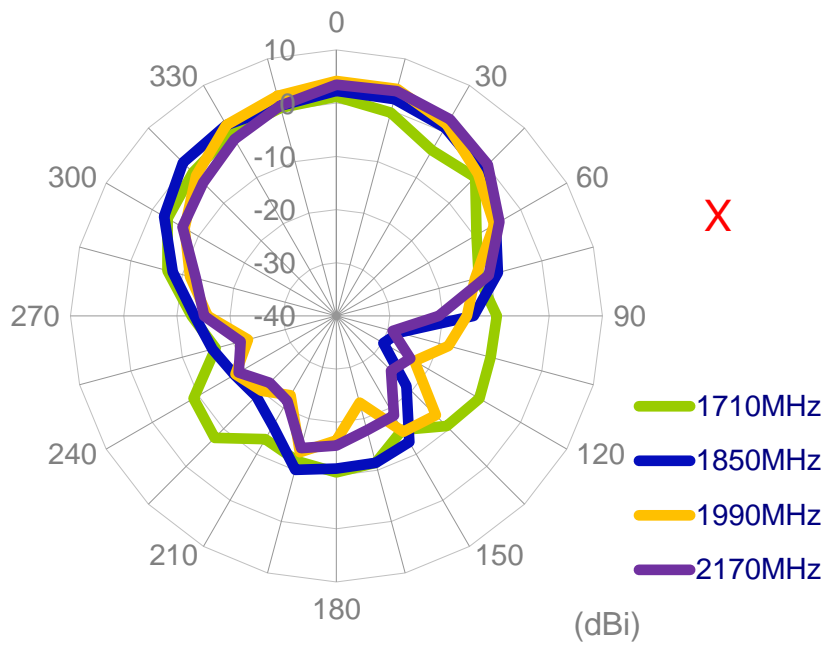

Z

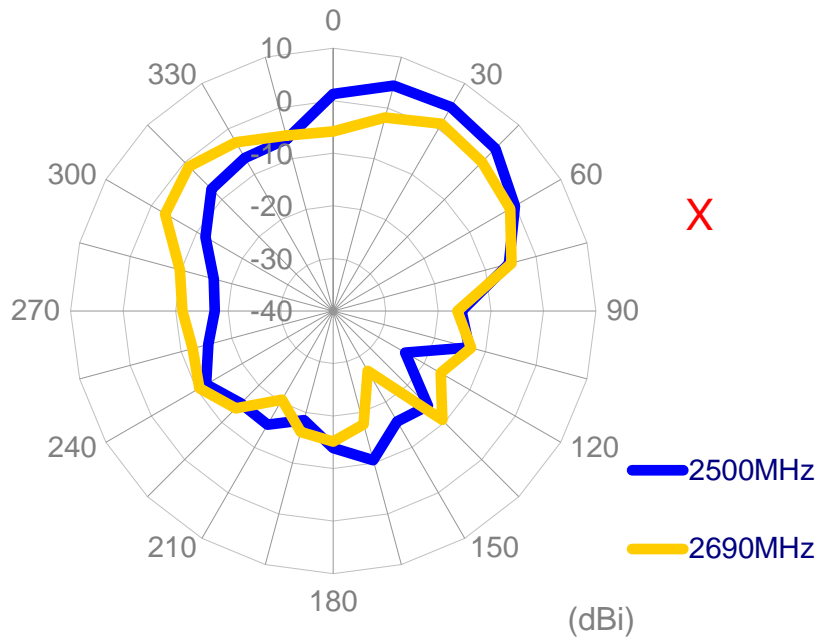

Z

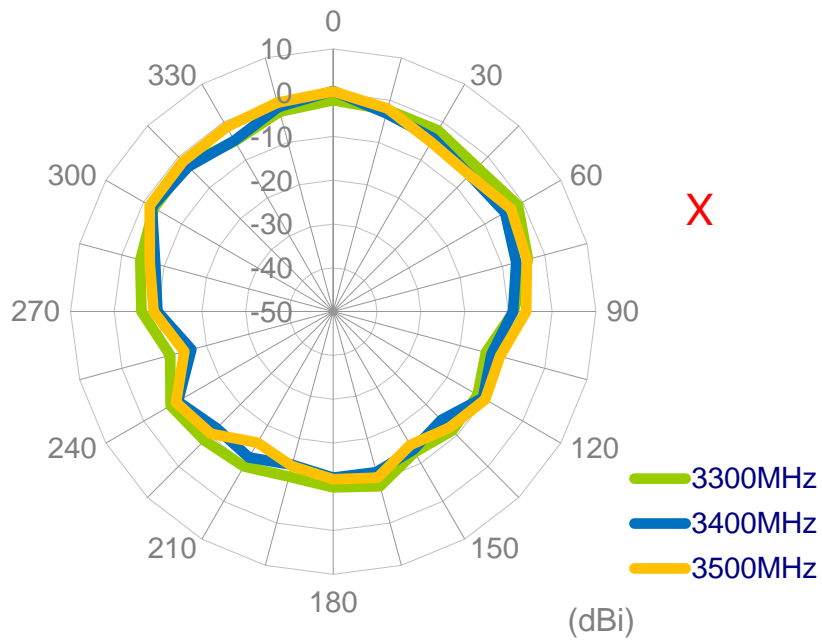

YZ Plane

Z

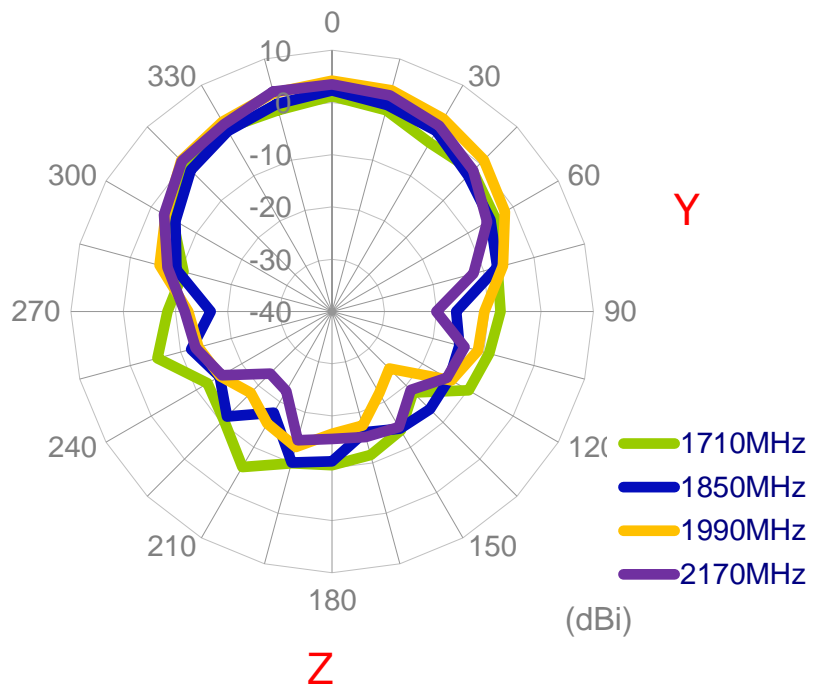
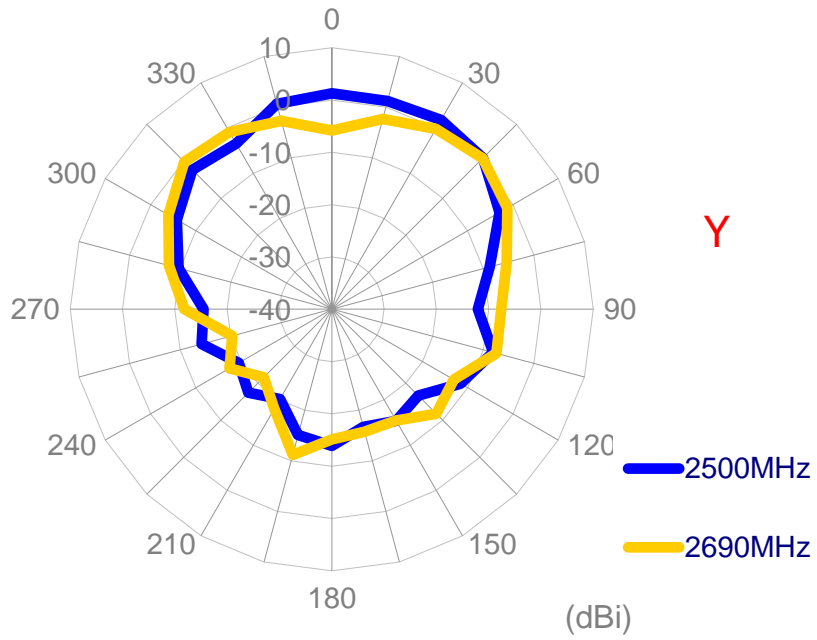

Y

Z

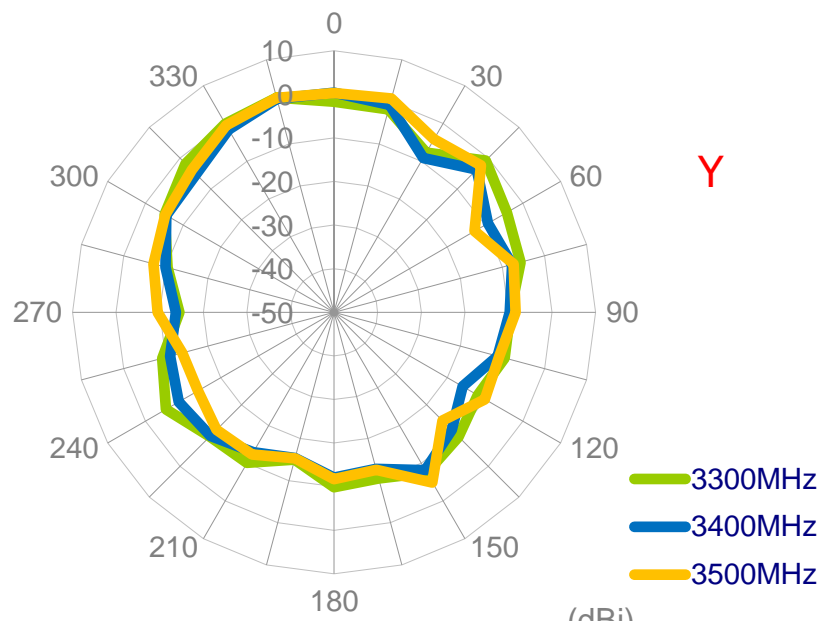

Y

3.1.8 3D Radiation pattern (LTE with 5M cable length on the 50*50 ground plane)

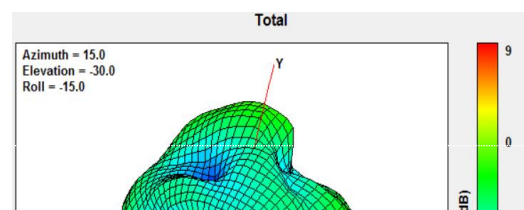
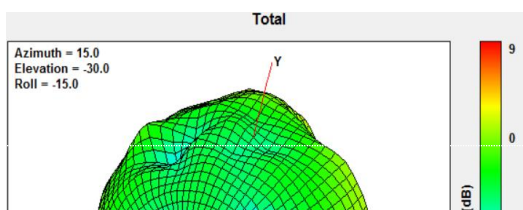

704MHz

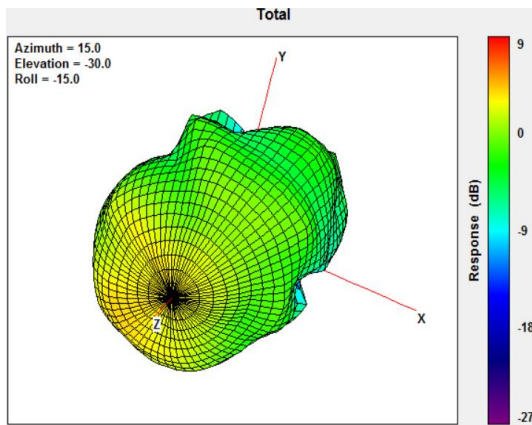

960MHz

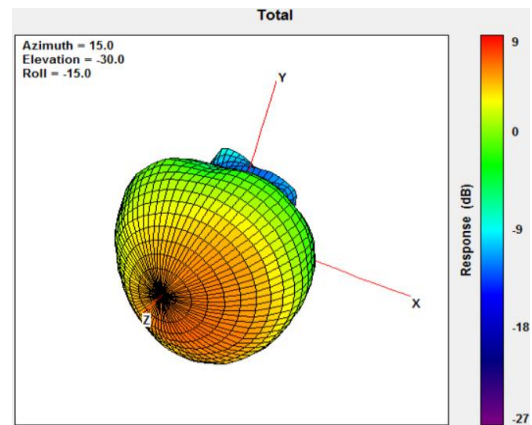

1710MHz

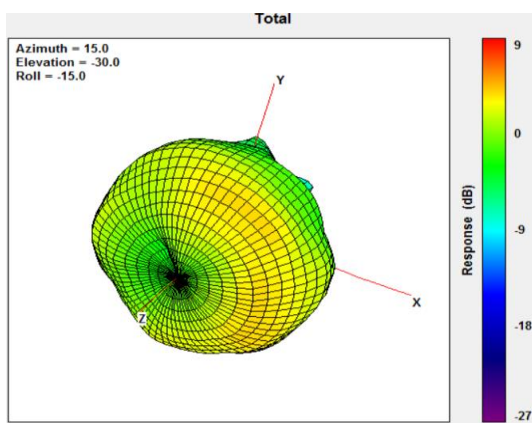

2170MHz

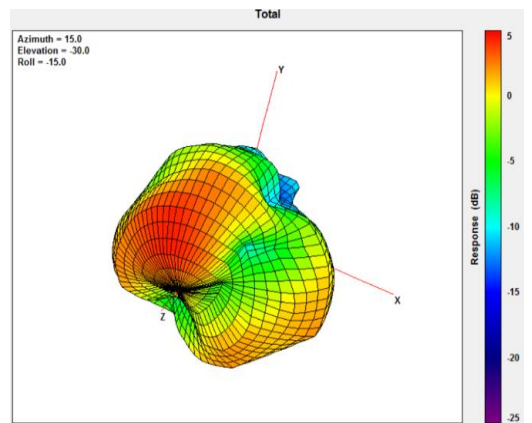

2690MHz

3500MHz

3.1.9 Test Setup for Antenna Radiation Pattern (ETS Anechoic chamber)

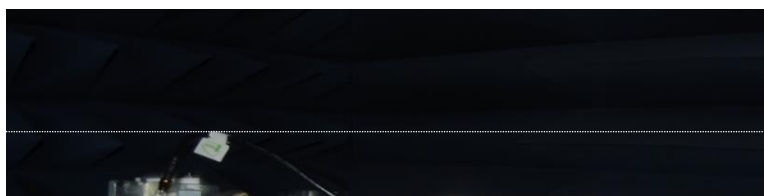

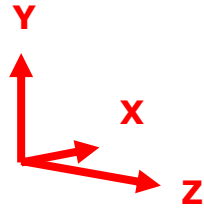

In free space

3.1.10 2D Radiation pattern (LTE with 5M cable length in free space)

XY Plane

X

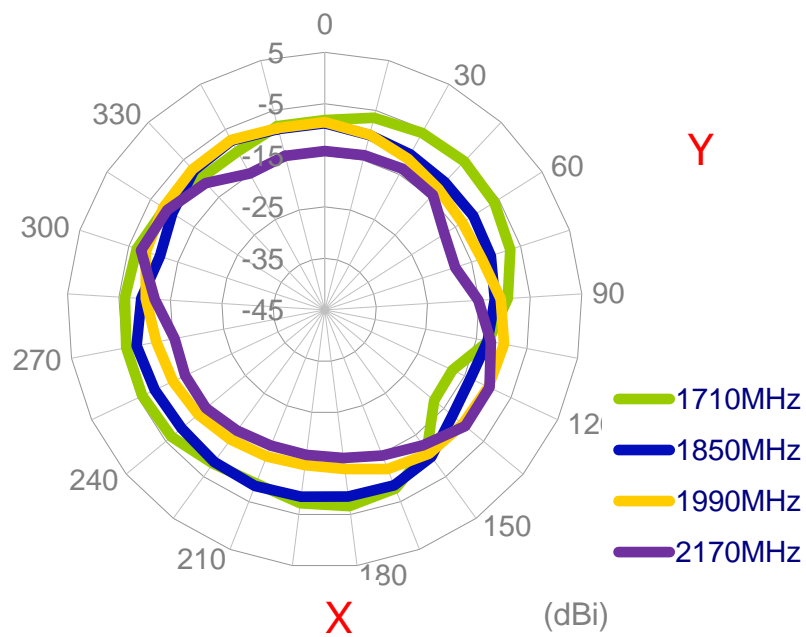
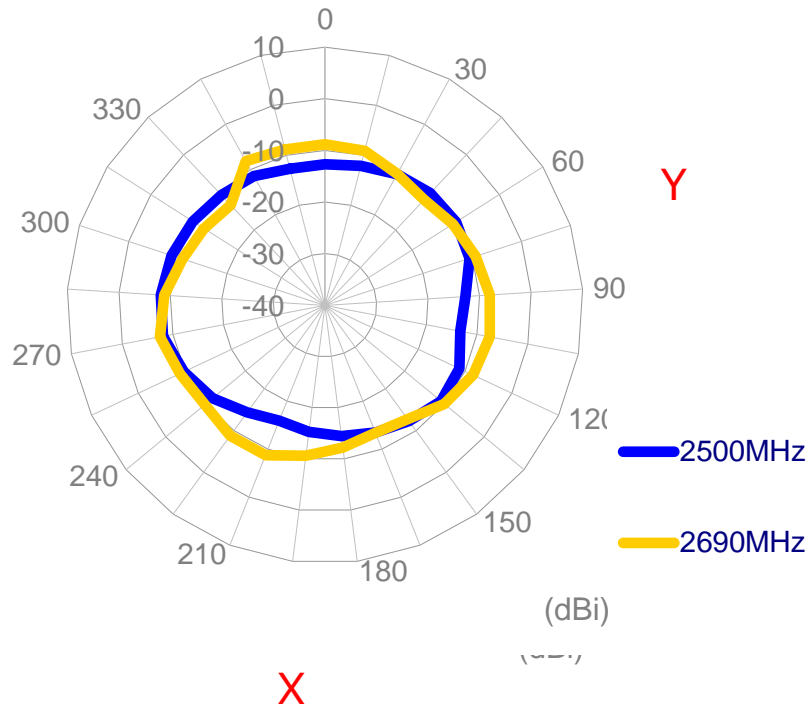

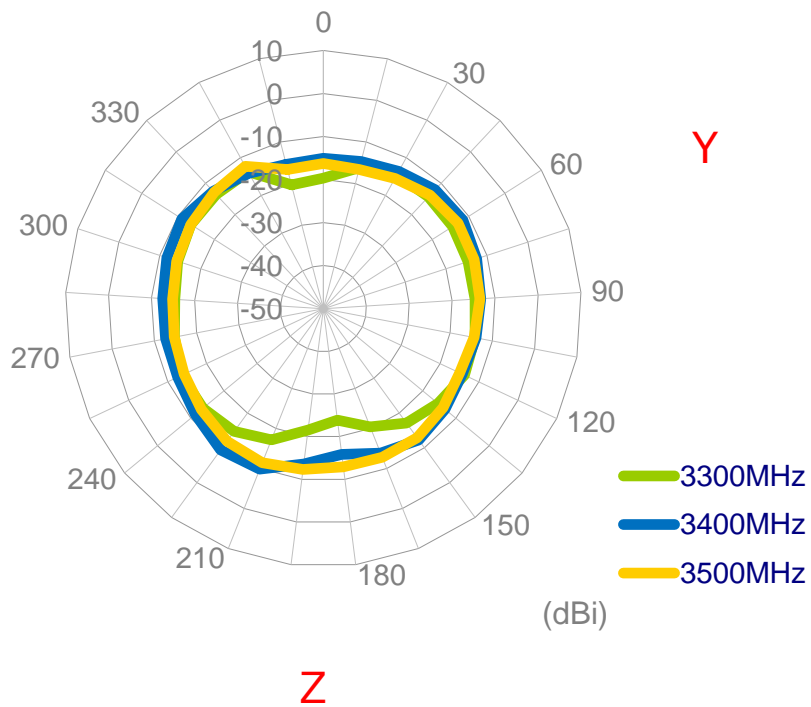
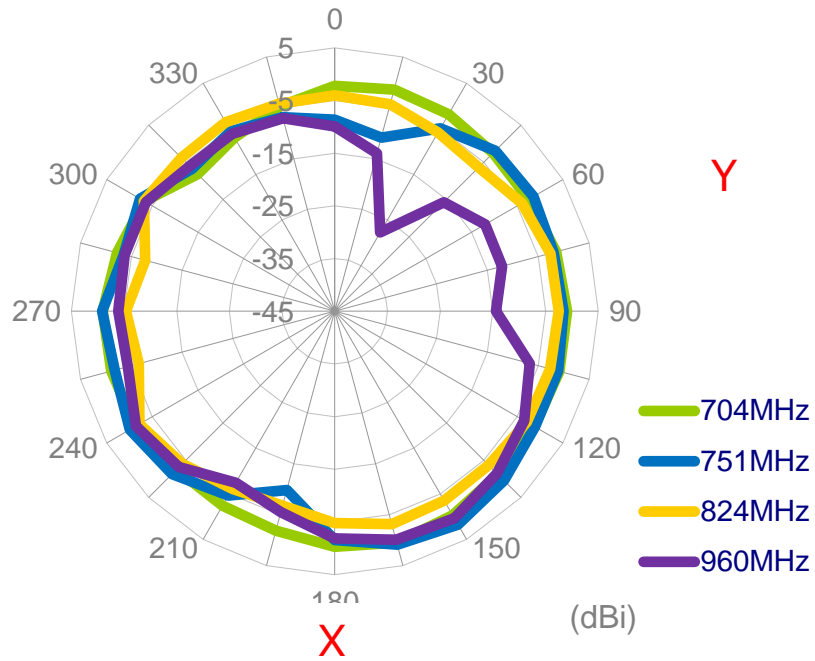

XZ Plane

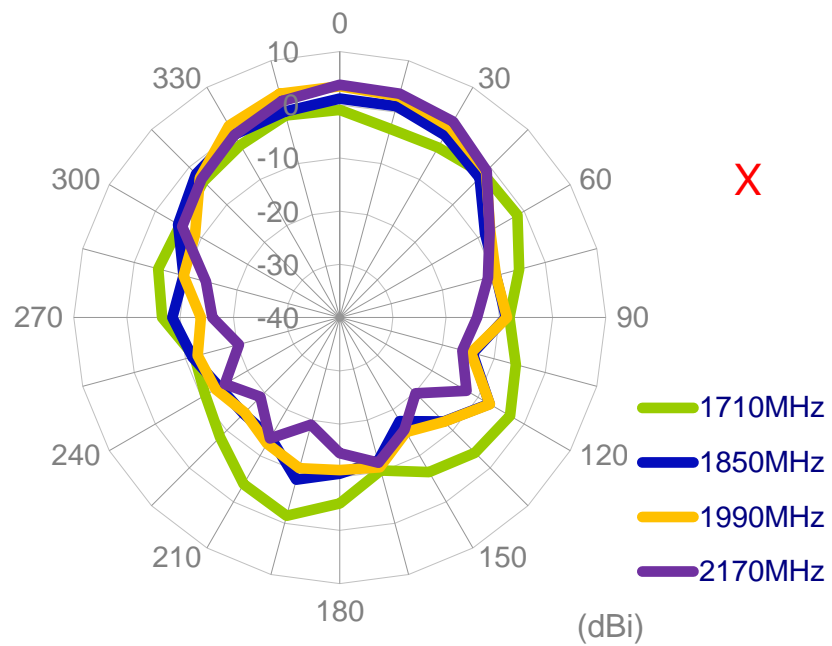
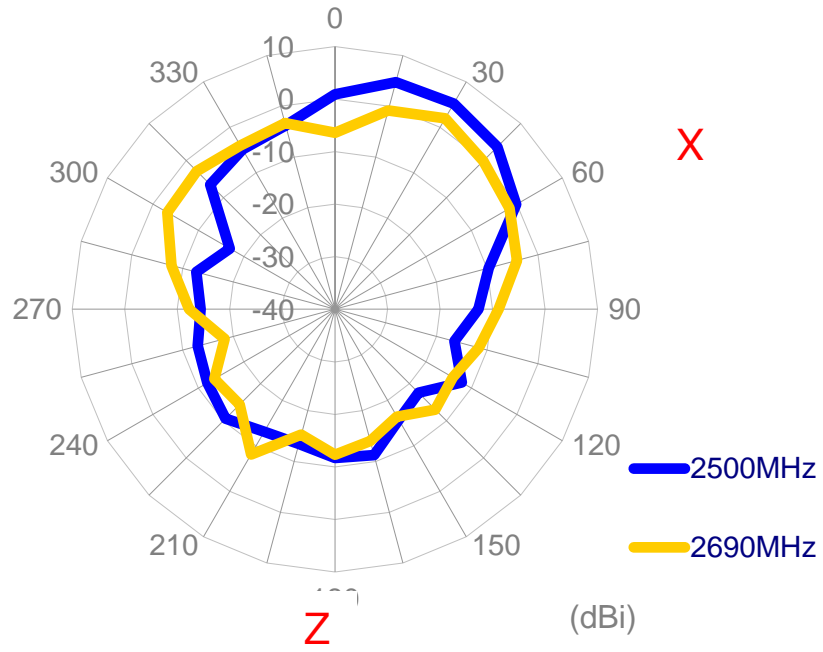

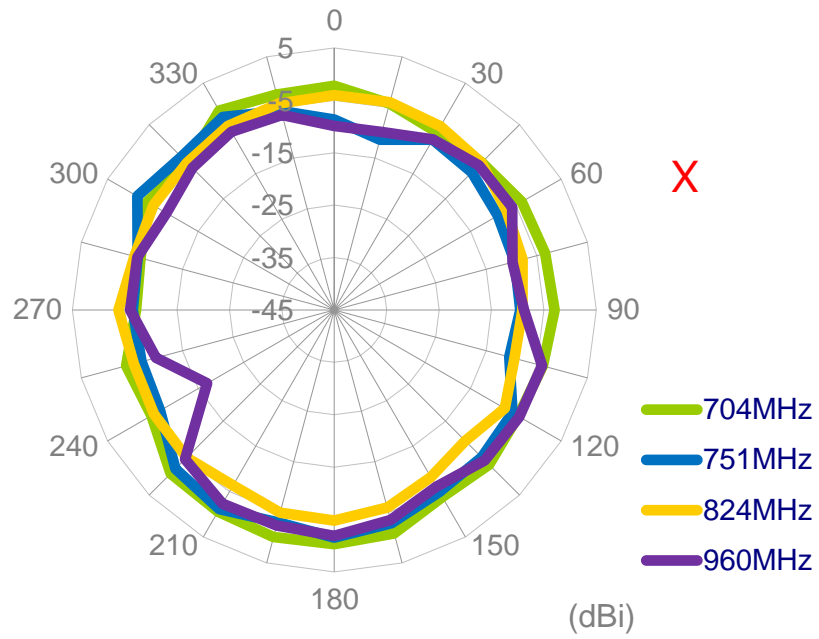

Z

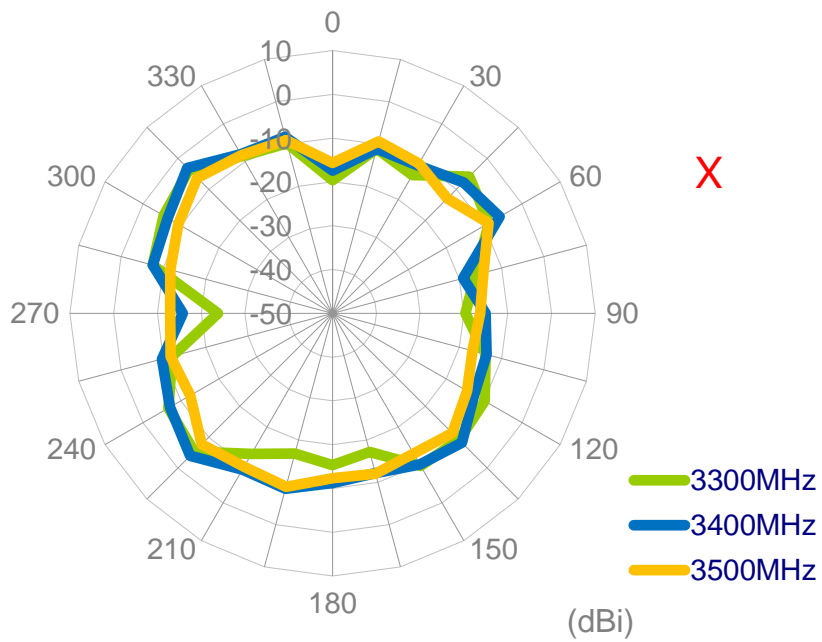

YZ Plane

Z

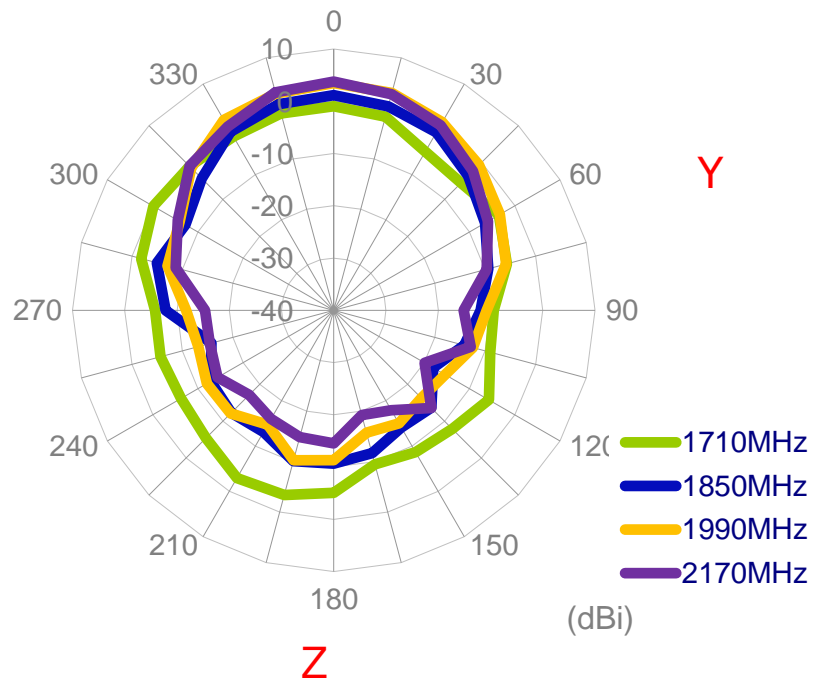
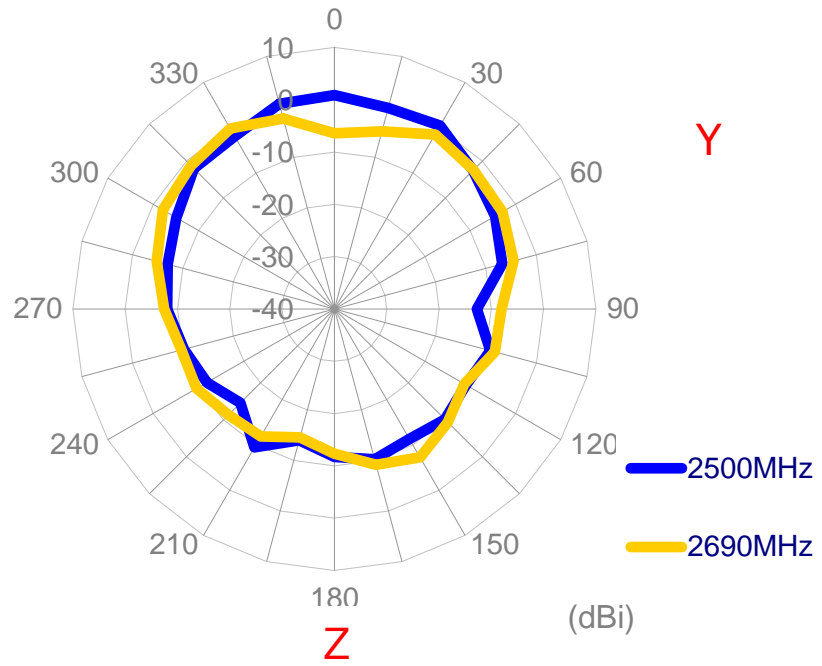

Y

Z

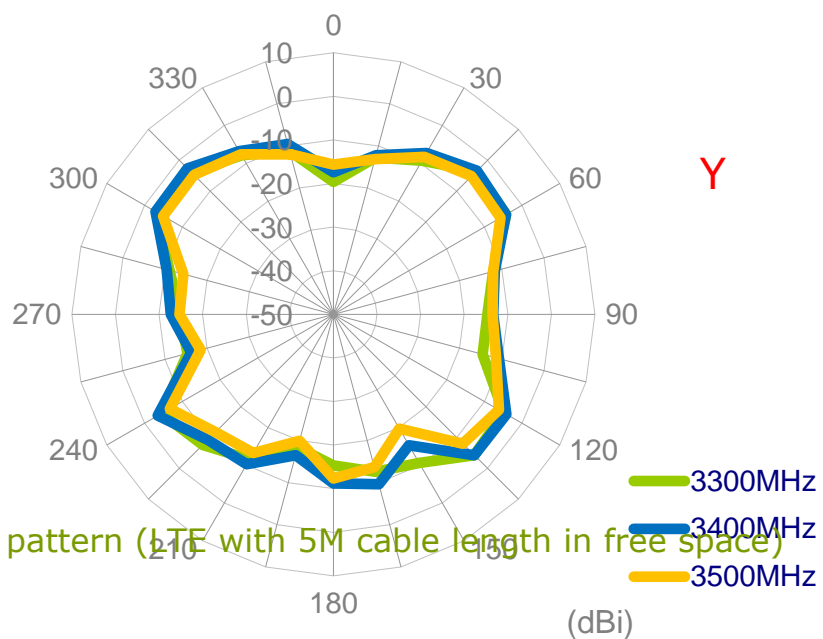

3.1.11 3D Radiation pattern (LTE with 5M cable length in free space)

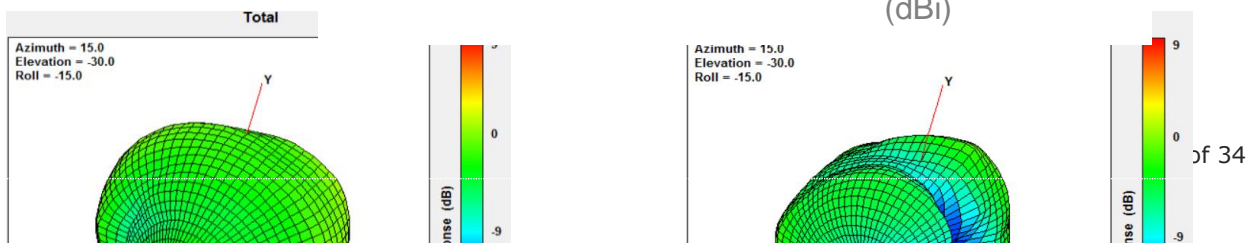

704MHz

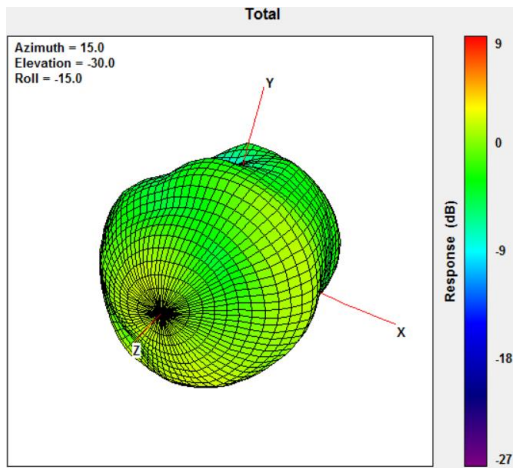

960MHz

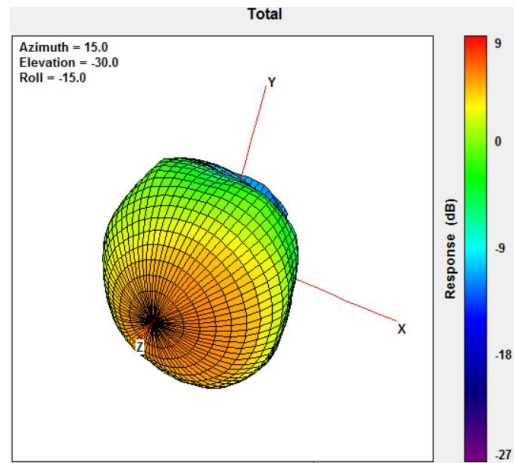

1710MHz

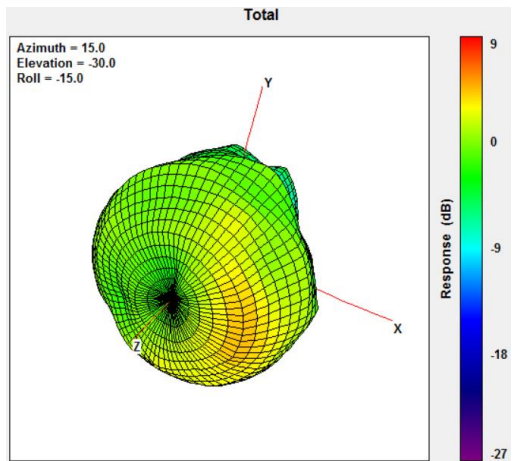

2170MHz

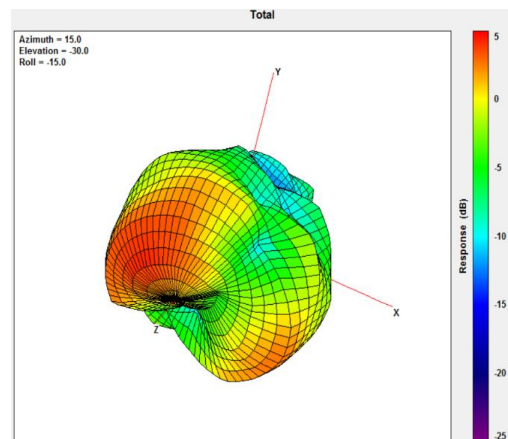

2690MHz

3500MHz

4. Mechanical Drawing (Unit: mm)

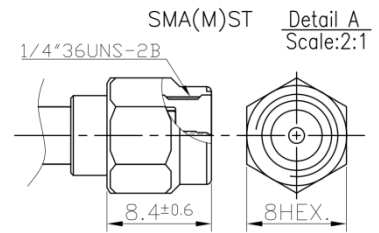
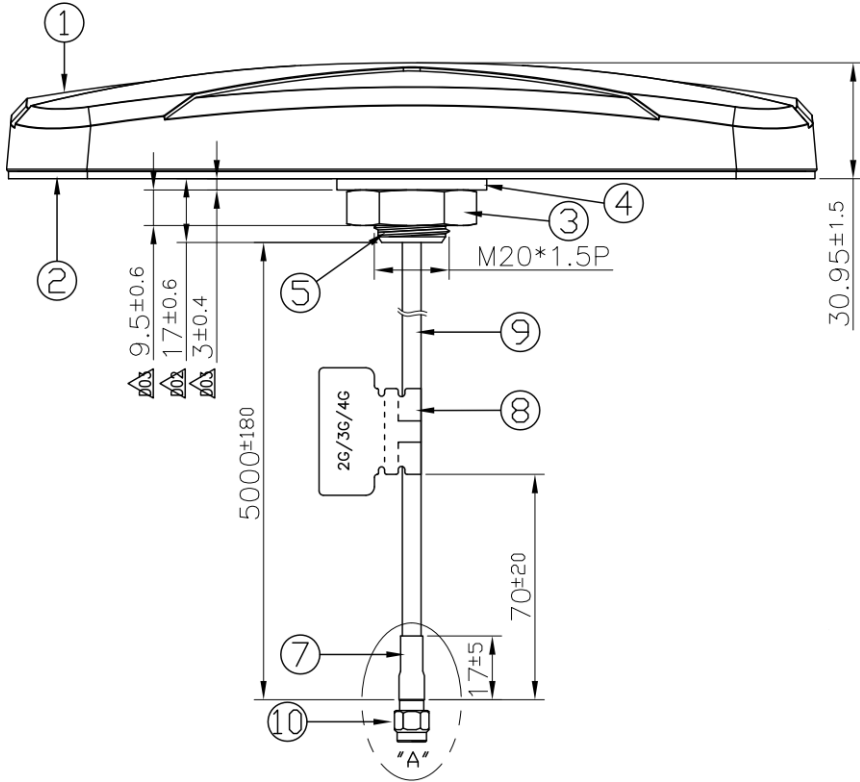
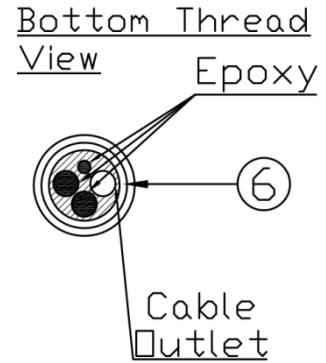
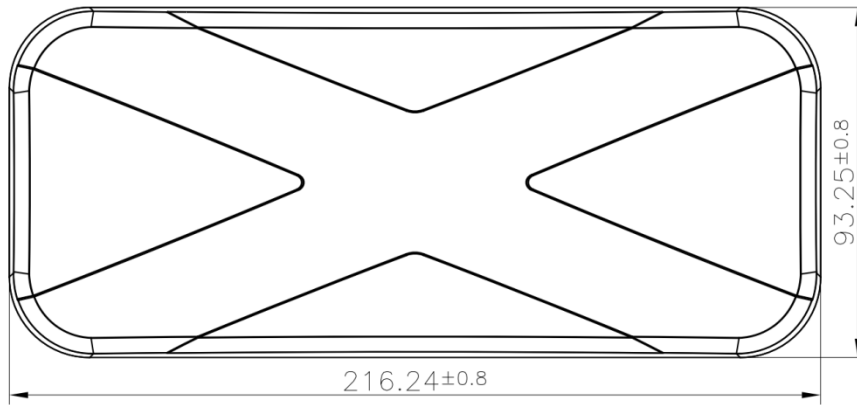

	Name	P/N	Material	Finish	QTY
1	Housing	000113K000066A	ABS+PC	Black	1
2	Closed Cell Foam	001013K000039A	3M 9448+CR-4305	Black	1
3	Nut_M20x1.5Px10H Cut	000413E030061A	Steel	Ni Plated	1
4	Washer_Cut	000413E040061A	Steel	Ni Plated	1
5	Metal Base	000313K000060A	AL	Ni Plated	1
6	Cable Rubber	000713E000063A	Silicone Rubber	Black	1
7	Heat Shrink Tube	001315C030000A	PE	Black	1
8	2G/3G/4G Label	001014C020051A	Coated Paper	White	1
9	CFD200 Coaxial Cable	301415C010000A	PVC	Black	1
10	SMA(M)ST	200211G010013A	Brass	Au Plated	1

5. Installation

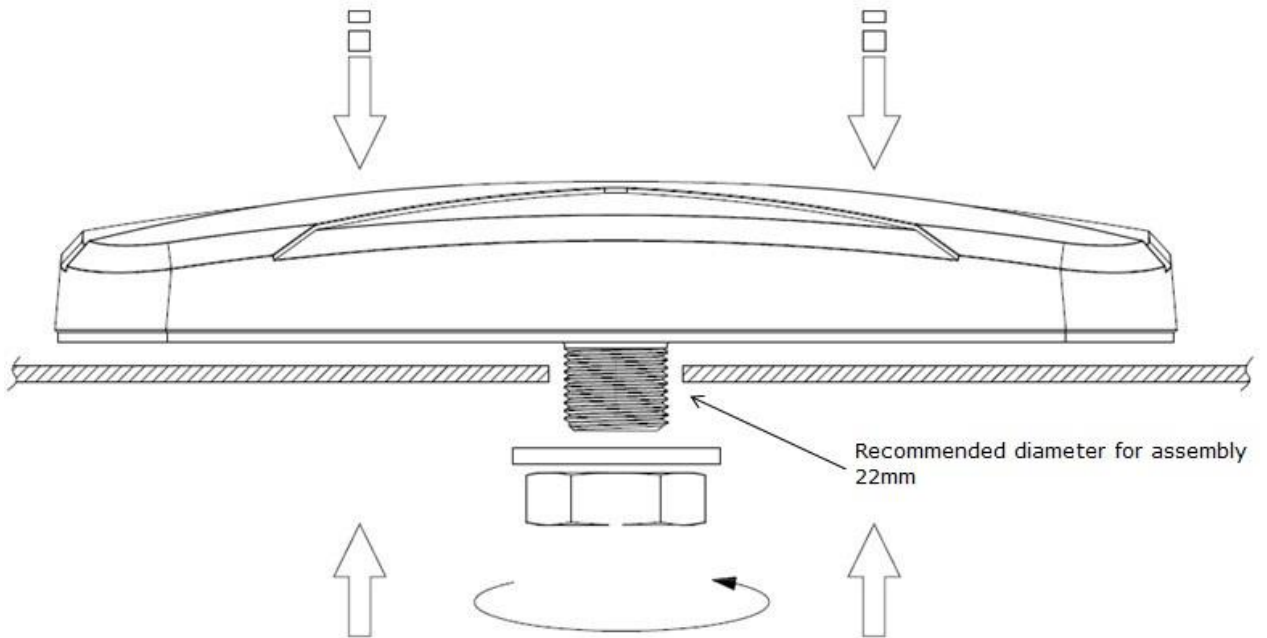

Recommended torque for mounting is 29.4 N.m
Maximum torque for mounting is 39.2 N.m

6. Packaging Specifications

1pc MA413.A.B105111 per small box
 Box Dimensions - 325x125x106mm
 Weight - 630g

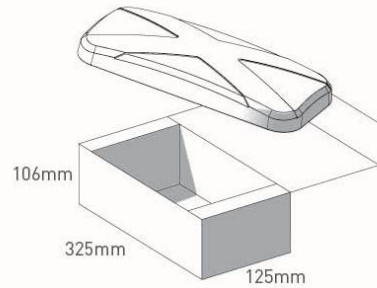

9 small boxes in one carton
 Carton Dimensions - 360x360x400mm
 Weight - 6.57Kg

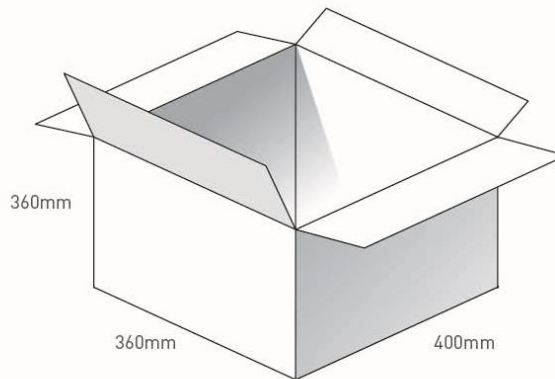

Pallet Dimensions 1080x720x1350mm
 15 Cartons per Pallet
 5 Cartons per layer
 3 Layers

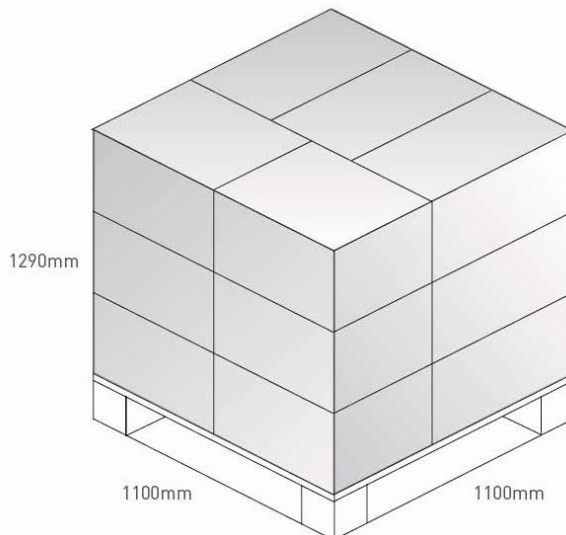

7. Application Note (LTE Antenna)

The MA413 antenna performance with different cable lengths and different environments is shown below.

7.1 On 50*50cm ground plane

7.1.1 Return Loss (MIMO_1 on the 50*50cm ground plane)

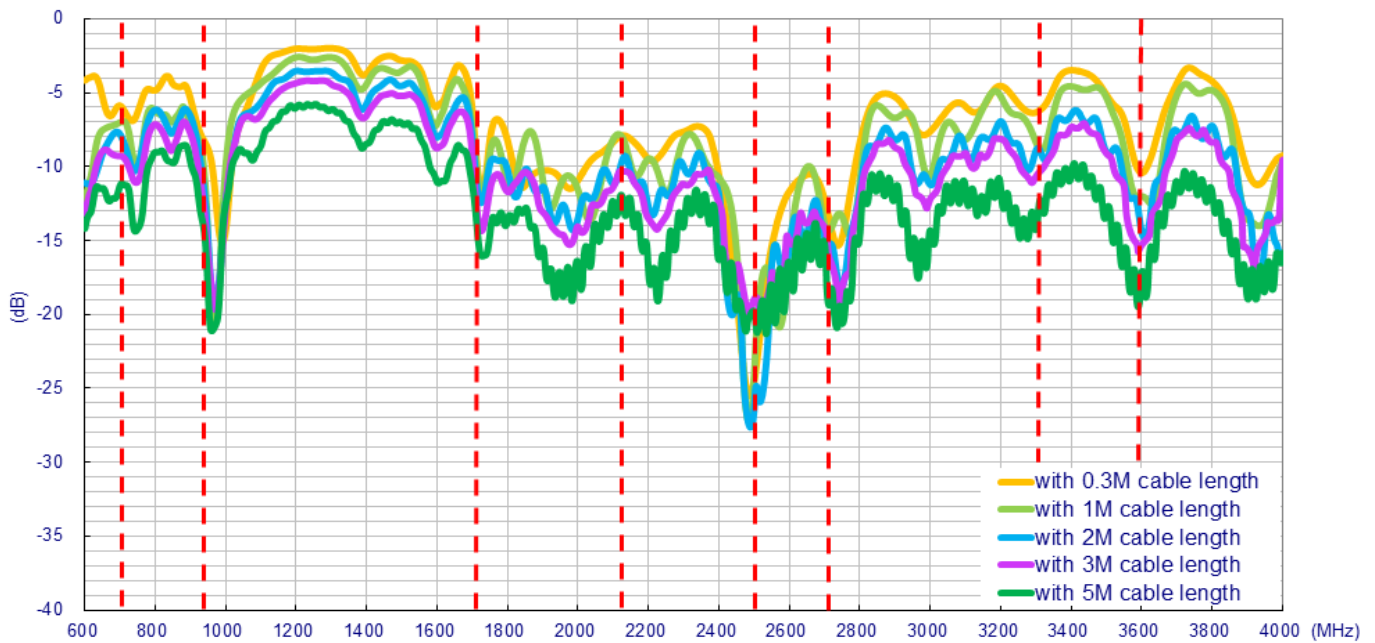

7.1.2 Efficiency (MIMO_1 on the 50*50cm ground plane)

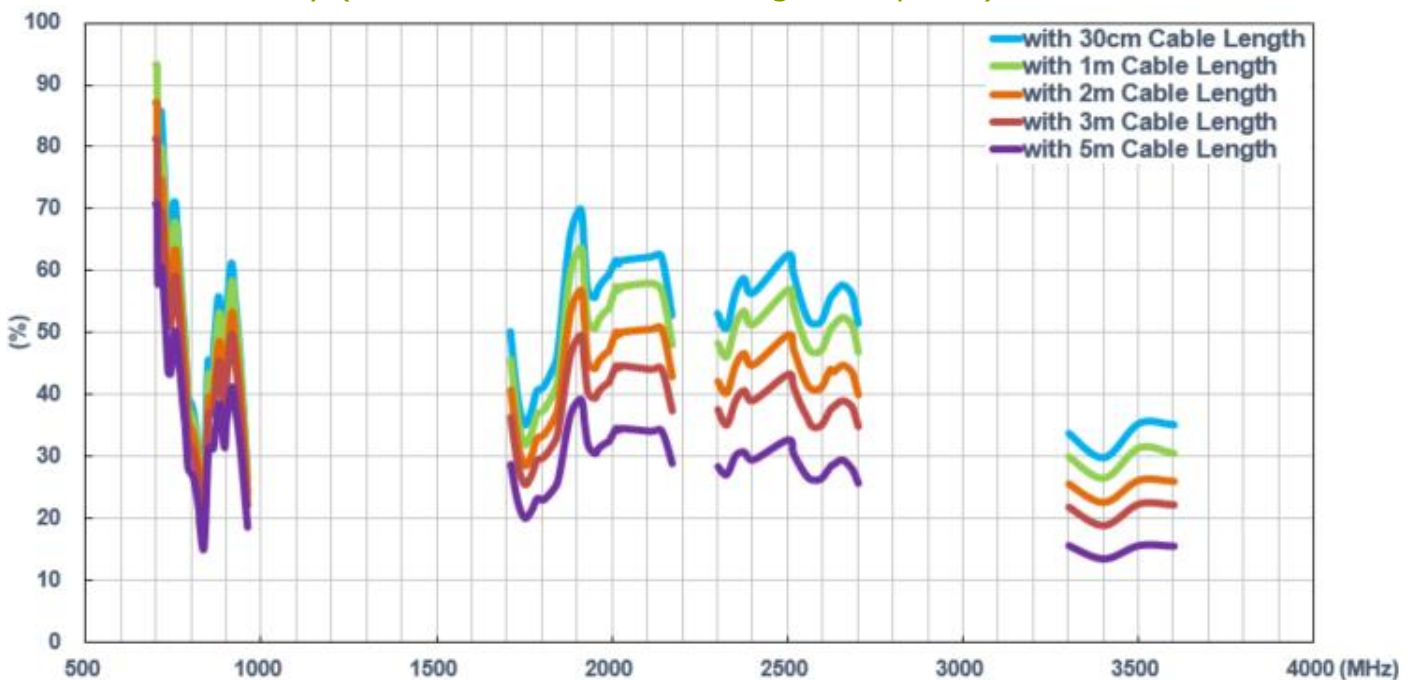

7.1.3 Average Gain (MIMO_1 on the 50*50cm ground plane)

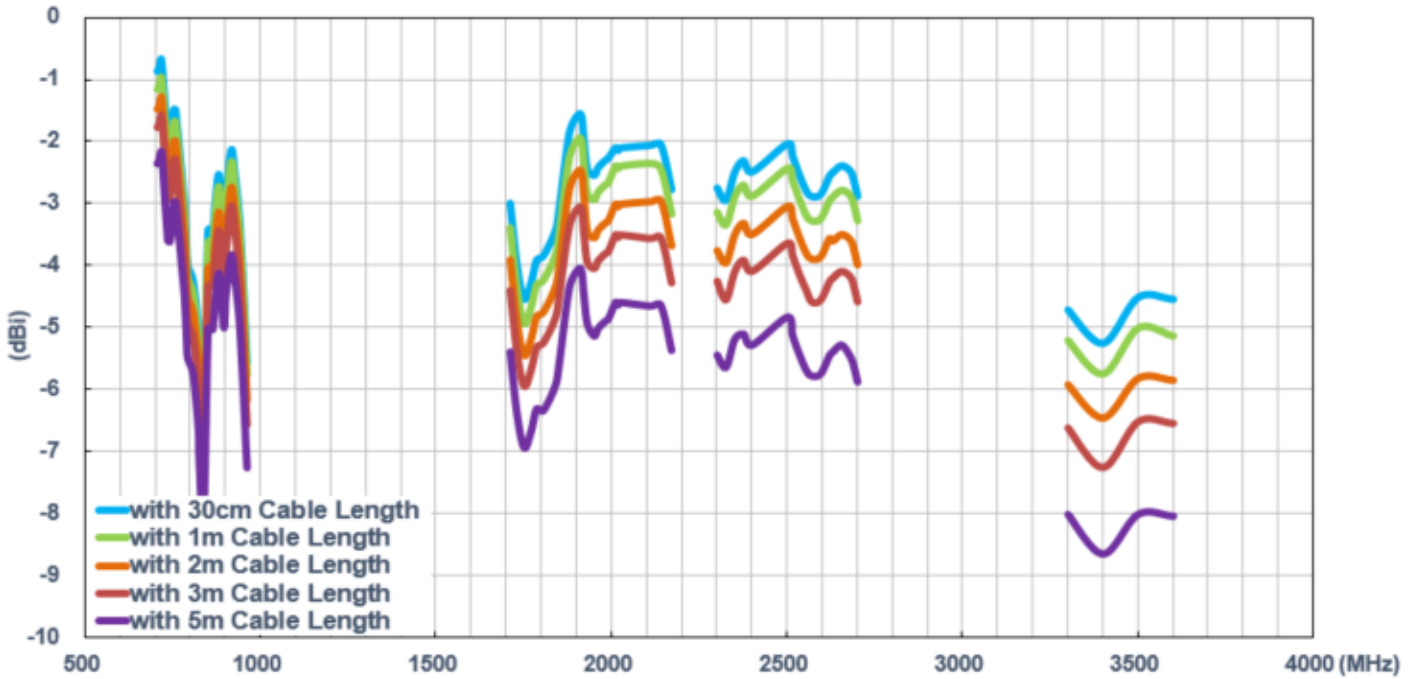

7.1.4 Peak Gain (MIMO_1 on the 50*50cm ground plane)

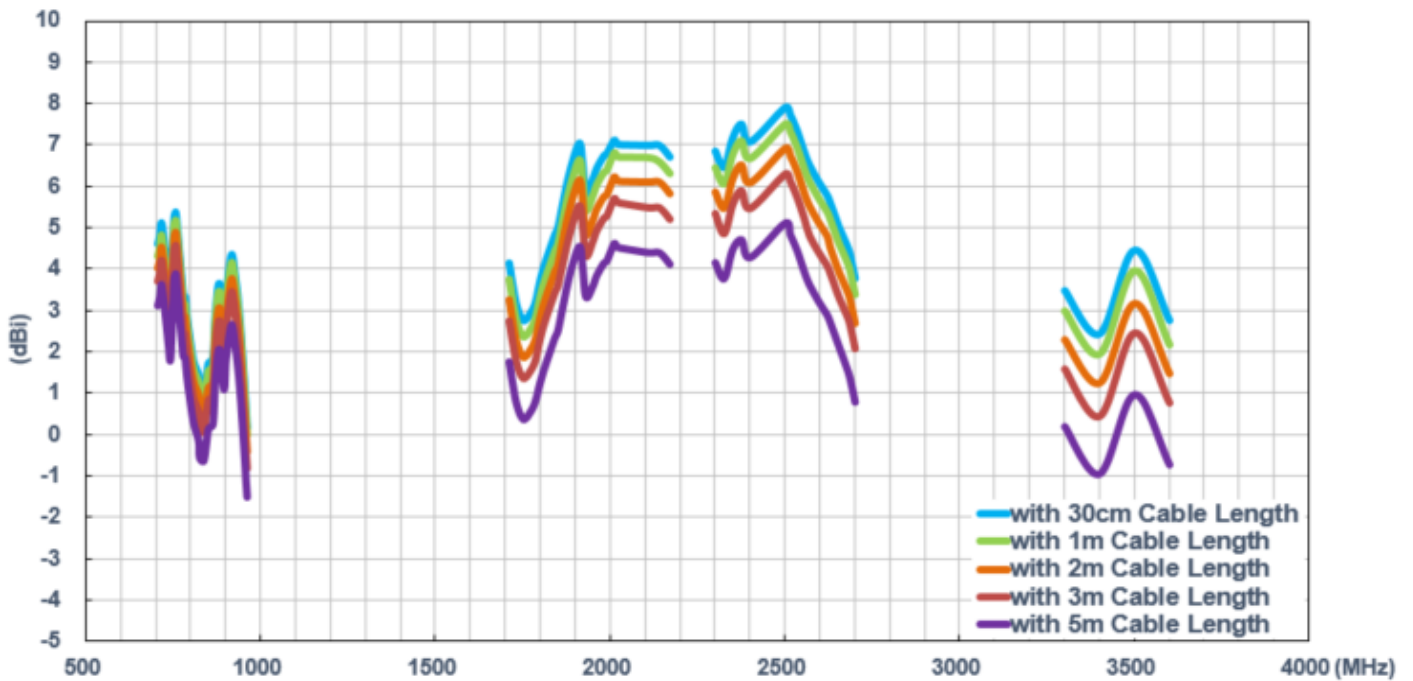

7.2 In free space

7.2.1 Return Loss (MIMO_1 in free space)

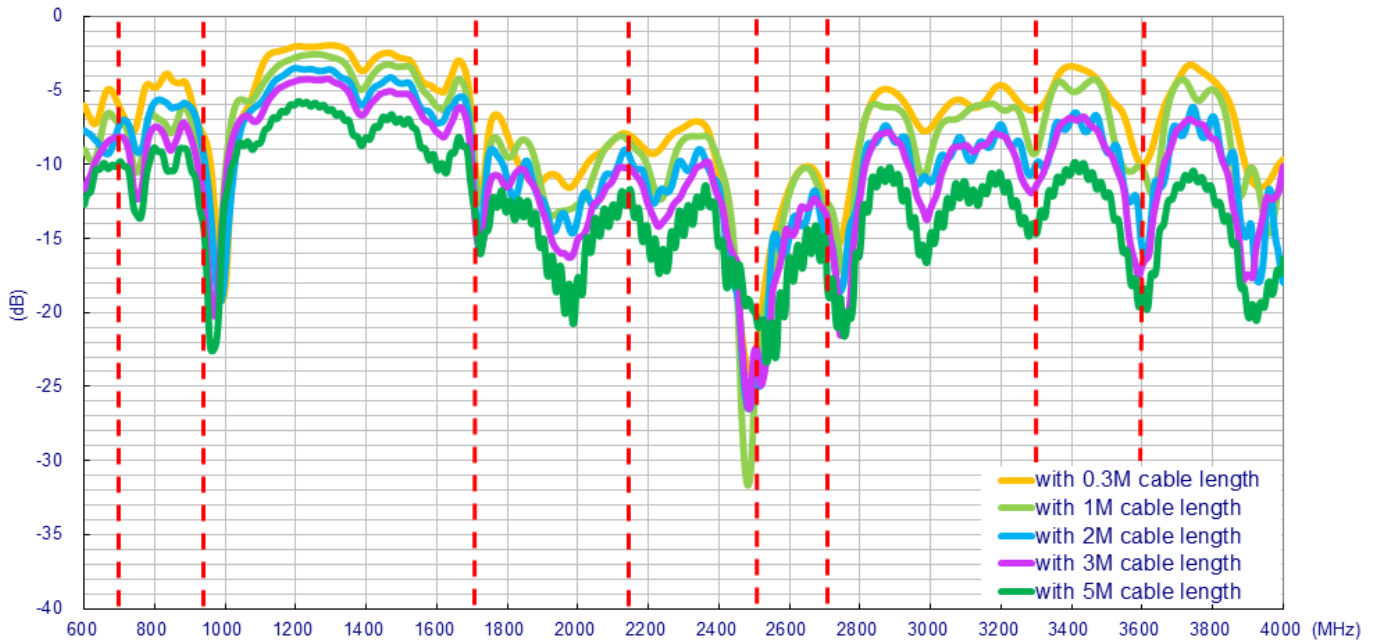

7.2.2 Efficiency (MIMO_1 in free space)

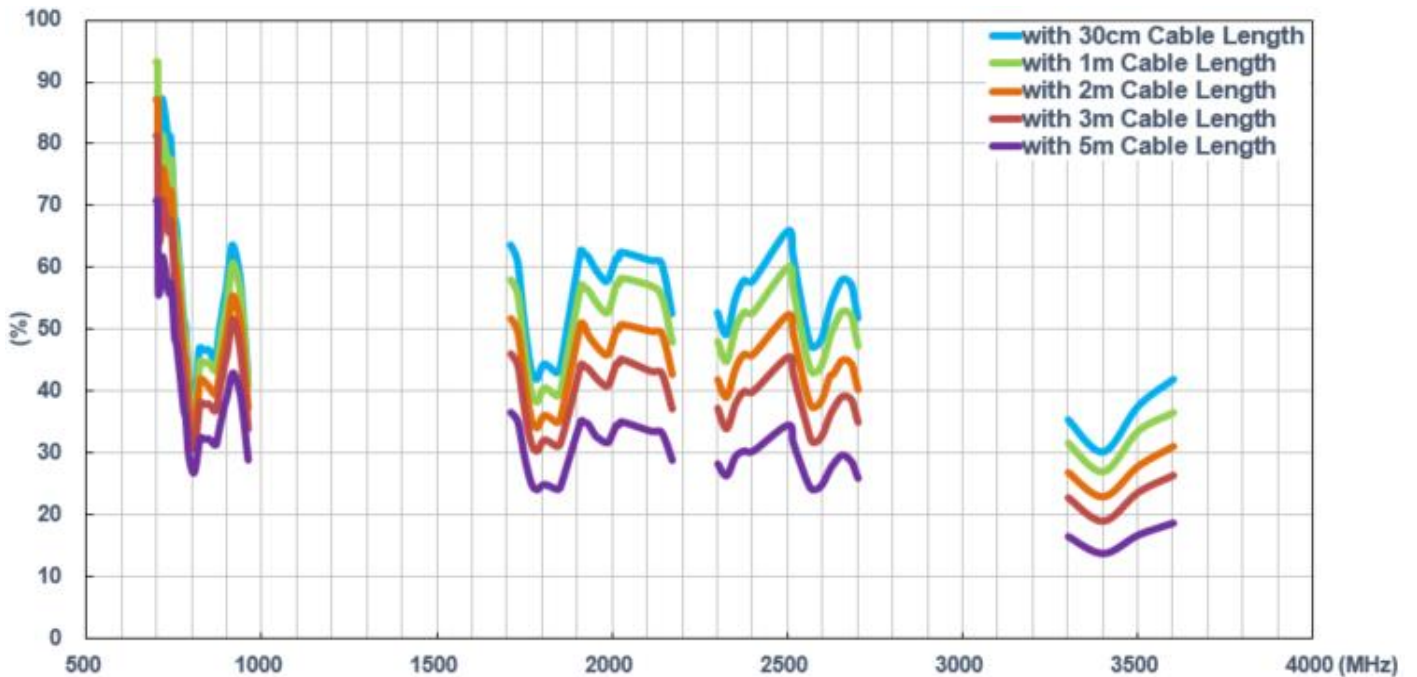

7.2.3 Average Gain (MIMO_1 in free space)

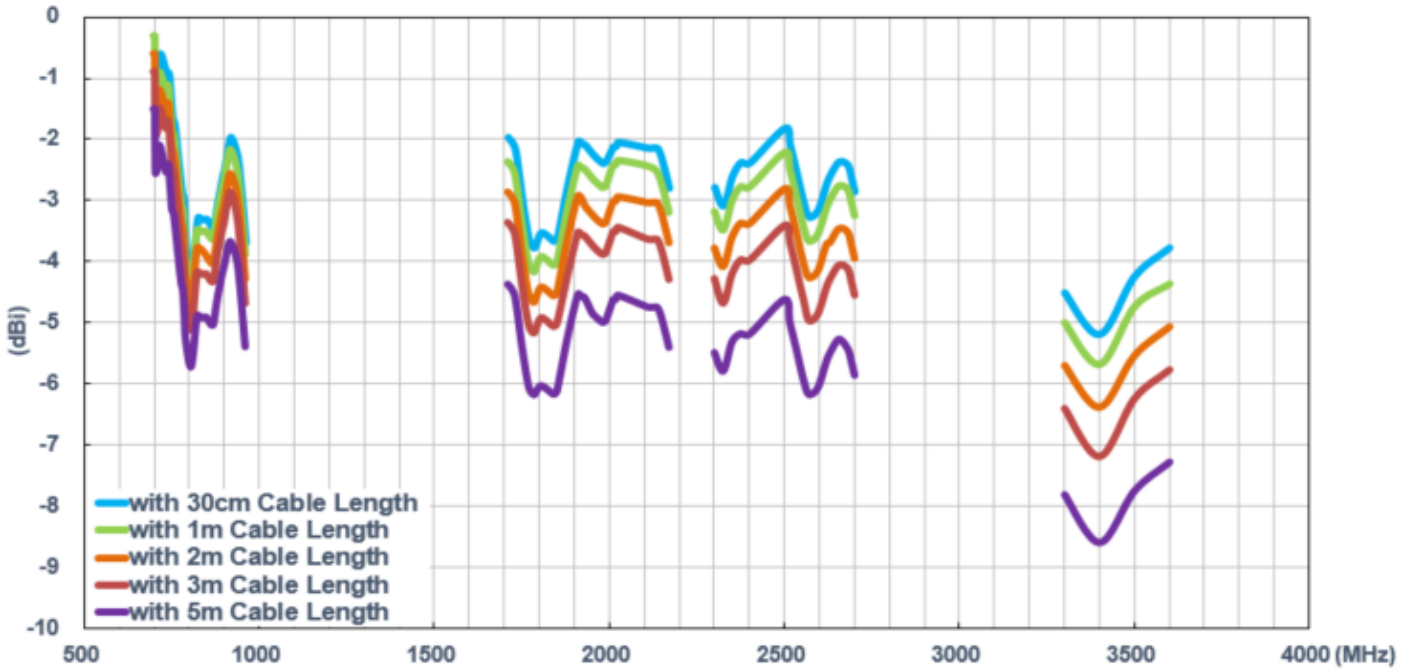

7.2.4 Peak Gain (MIMO_1 in free space)

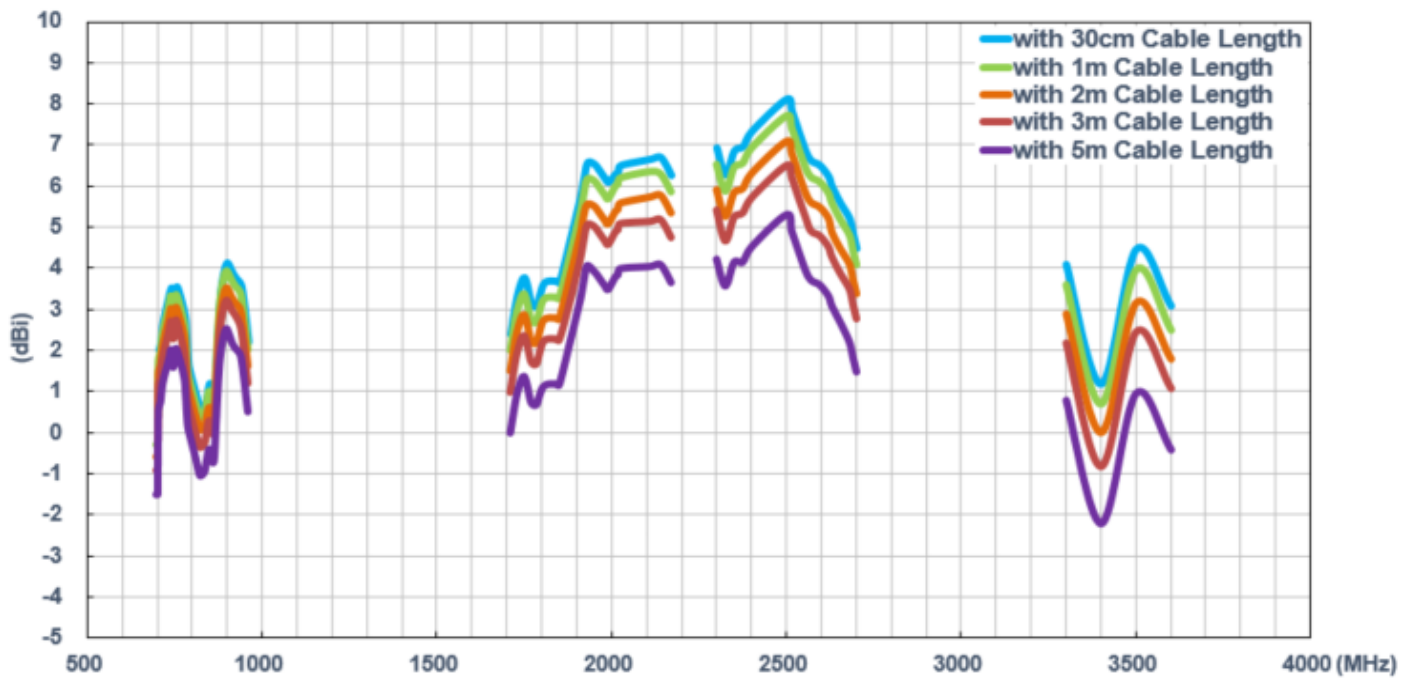



Taoglas makes no warranties based on the accuracy or completeness of the contents of this document and reserves the right to make changes to specifications and product descriptions at any time. Taoglas reserves all rights to this document and the information contained herein.

Reproduction, use or disclosure to third parties without express permission is strictly prohibited.

Copyright © Taoglas