

DESCRIPTION

Demonstration circuit 1894B is a daisy-chainable isoSPI battery-stack monitor featuring the [LTC®6804-1](#). These boards can be linked through a 2-wire isolated serial interface to monitor any number of cells on a stack.

Communication to a PC uses a DC590 USB interface board. A control program for up to ten stacked boards has a Graphical User Interface (GUI) to implement the device command set.

Multiple DC1894B can be daisy-chained using RJ45 terminated Ethernet patch cables.

Design files for this circuit board are available at <http://www.linear.com/demo/DC1894B>

LT, LT, LTC, LTM, Linear Technology and the Linear logo are registered trademarks and QuikEval is a trademark of Linear Technology Corporation. All other trademarks are the property of their respective owners.

HARDWARE SETUP

Separate the screw-terminal section from J1 and wire cell voltage connections or resistors into the clamping contacts to provide the input stimulus for the ADC.

Cell voltages are wired from position 4 (most negative potential of the group) with increasing potentials up to position 16 (most positive potential).

Alternatively, resistors can be used to simulate battery cells. For this, connect twelve 100Ω leaded resistors between each contact from position 4 to position 16. Provide

a stack-equivalent power supply connection to position 16 (positive) and position 4 (return). The supply may be adjusted to provide the desired nominal cell voltage (ex. 40V will be 3.33V/cell).

Figure 1 shows the following connections for two boards on a stack interfaced to a PC:

1. Connect a USB cable from the PC USB port to DC590.
2. Connect a 14-pin ribbon from DC590 to the SPI BOTTOM connector (J2) on the bottom DC1894B board.

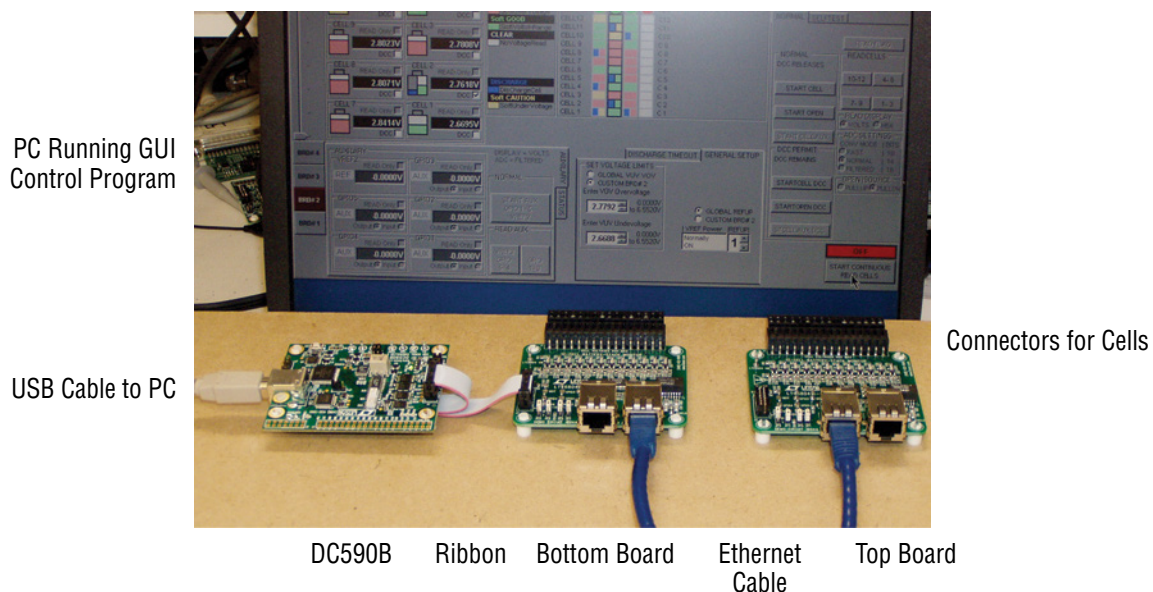

Figure 1. Connecting a Two Board Stack to a PC

DEMO MANUAL DC1894B

HARDWARE SETUP

3. Connect an RJ45 cable from the bottom DC1894B isoSPI B RJ45 connector (J4) to the next DC1894B isoSPI A RJ45 connector (J3).

Additional boards can be connected in the same manner, using RJ45 terminated Ethernet patch cables.

4. Set the jumpers on each DC1894B as shown in Figure 2 and Table 1.

5. Mate the J1 cell-voltage connectors.

Table 1.

JUMPERS	0 POSITION	1 POSITION
JP4-Discharge Timer	Timer Disabled	Timer Enabled
	BOTTOM BOARD	UPPER BOARDS
JP1-Chip Select	SPI 14-Pin	isoSPI RJ45
JP2-Clock	SPI 14-Pin	isoSPI RJ45
JP3-Isolated Mode	Normal SPI	2-Wire isoSPI

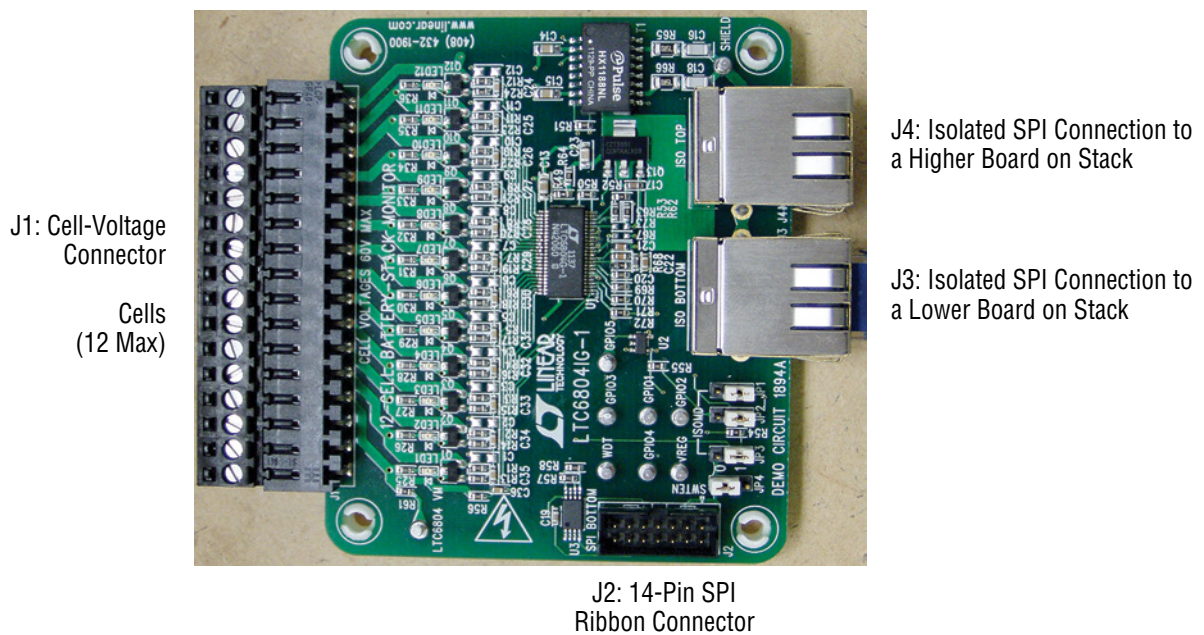

Figure 2. Connections and Jumpers

SOFTWARE SETUP

QUIKEVAL DRIVER

To use the DC590B USB Interface board, the PC must first have the proper driver installed. To do this, download the QuikEval™ software from Linear Technology, at www.linear.com:

http://www.linear.com/designtools/software/quick_eval.jsp

1) Install the QuikEval software by running the executable `lqcgev.exe`. Follow the instructions to connect DC590B.

NOTE: You will be instructed to ensure that the DC590B is not connected to the PC:

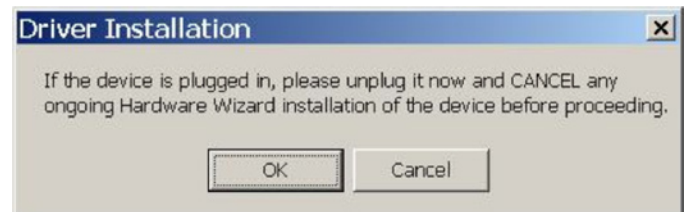

If you fail to unplug the DC590B, the DC590B driver `FTD2XX.DLL` will not install!

2) When installation of QuikEval is complete, close the QuikEval program.

SOFTWARE SETUP

- 3) Reopen QuikEval, and then connect the DC590B to confirm that QuikEval software was installed correctly. If properly installed, QuikEval will show the following message:



If not properly installed, QuikEval will be unable to connect to the DC590B. Please retry the software installation, with the DC590B disconnected.

- 4) Connect the LTC6804 Demoboard to the DC590B with QuikEval software open.
- 5) The QuikEval software will recognize when the LTC6804 demo board has been found, and will offer to download and install the module from the LTC website:

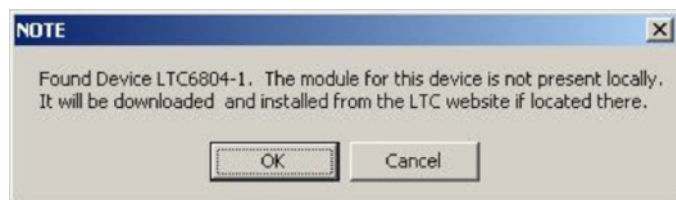

At this point, select cancel (Remember, QuikEval will not be used to communicate with the LTC6804 demo board). If you select OK, instead of cancel, QuikEval will report that the module is not available on the LTC website.



- 6) The QuikEval software will open and indicate that the LTC6804 device has been found. It will also indicate that there is no module for this device. This is normal and indicates that QuikEval does not directly control the LTC6804 demo boards:



- 7) Close QuikEval Software, as it is no longer needed for this demosystem.

LTC6804 Graphic User Interface

The LTC6804 Graphic User Interface (GUI) is provided in a zipped file, LTC6804_GUI_Vxx_yyyymmdd.zip.

- 1) Unzip this folder
- 2) Run the setup.exe file to start installation
- 3) Ignore the security warning by selecting Install.
- 4) The GUI control panel appears immediately after installation. Subsequent starts of the GUI are done through the Windows Start menu or the optional Windows Desktop shortcut icon.

SOFTWARE SETUP

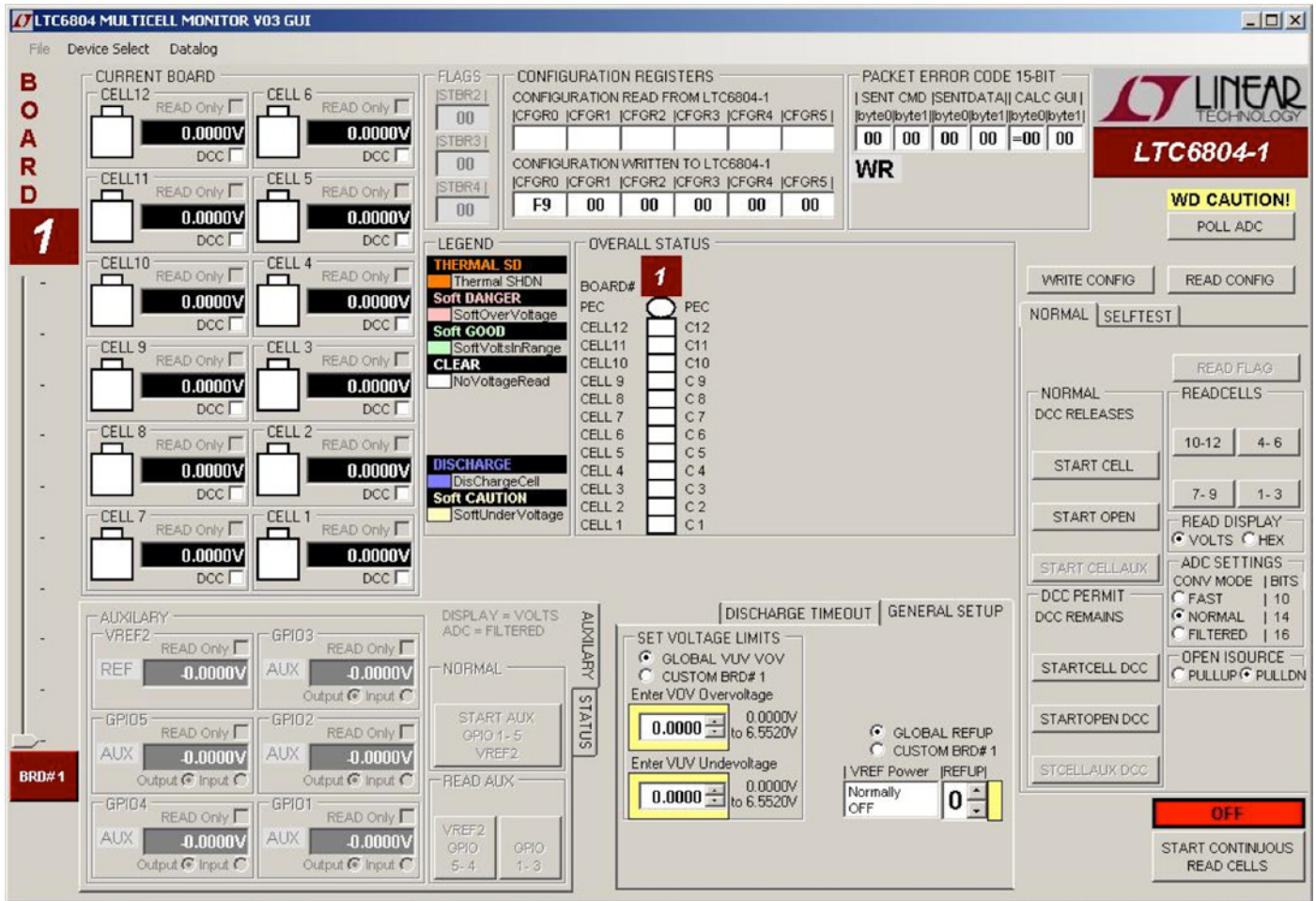

Figure 3. GUI Control Panel Start-Up Screen

OPERATING THE CONTROL SCREEN

FIRST

Figure 3 shows the GUI initial start-up screen. Once power is supplied to the board from a stack of cells or a power supply, the communication between the PC and the board can be checked.

1: READ CONFIGURATION

Click the command button labeled READ CONFIG. If all is properly connected and operating, the start-up default configuration of the LTC6804-1 will be read from the board. The Hex codes for the six bytes of configuration setting will appear in the CONFIGURATION REGISTERS section in the

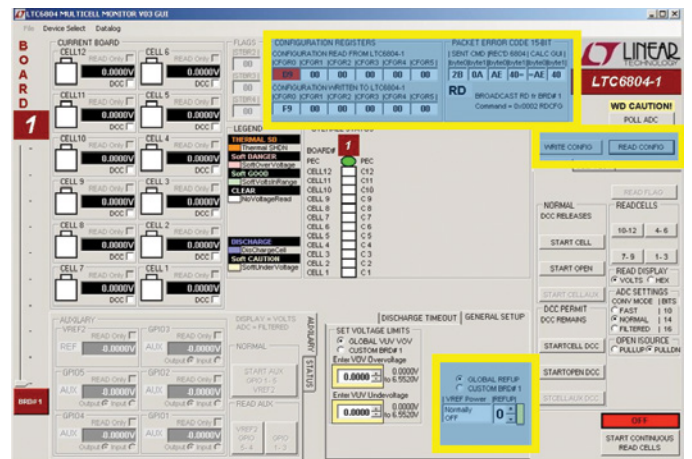

OPERATING THE CONTROL SCREEN

boxes labeled CONFIGURATION READ FROM LTC6804-1. The initial configuration bytes should be 0xD9 for register 0 and 0x00 for the other five bytes. This default configuration is the sleep mode for the LTC6804-1 on DC1894B.

The LTC6804 calculates a 15-bit Packet Error Code, PEC15, as a 16-bit word and appends it to the data stream each time it sends out data. The LTC6804 responds to the READ CONFIG command by sending six bytes. For the six bytes sent by a READ CONFIG command and received by the GUI, the control program also calculates a PEC15. The received PEC15 word and the calculated PEC15 word are displayed in the top section labeled PACKET ERROR CODE 15-BIT. The oval located at the top of the color coded status panel for the one board will turn green if the received and calculated PEC15 words match. Data transmission errors will produce red warning indications when the PEC15 words do not match. There is also a display of the PEC15 that was sent with the most recent command to the LTC6804, which had to match an internally calculated value to be accepted as a valid command.

2: WRITE CONFIGURATION

The GUI allows the user to configure the LTC6804, such as the undervoltage and overvoltage levels, and the operating state. However, setting the configuration within the GUI does not change anything within the LTC6804 until the Write Configuration command is executed. Clicking the WRITE CONFIG command button sends the configuration to the LTC6804. When the command is sent, the six Hex bytes shown in the box labeled CONFIGURATION WRITTEN TO LTC6804 will become bold type. This box provides the exact hex values required by the LTC6804 and can be used to facilitate control program development.

Clicking the READ CONFIG button can see confirmation that the configuration change was actually made. The six bytes read back should match the six bytes sent and the PEC15 should be a match (green PEC oval on stack display).

When any configuration information is changed on the screen, the WRITE CONFIG command button will be illuminated. This serves as a reminder that this command still needs to be executed.

NOTE: To get started, it is recommend to set REFUP to 1, followed by a WRITE CONFIG command. The Watchdog Timer (WDT) will now be continually serviced with the POLL ADC command and the stack is ready to be monitored. Leaving REFUP at the default setting of 0, the WDT times out in 2 seconds and all configuration information is reset.

3: PROGRAM THE CELL MONITORING VOLTAGE THRESHOLDS

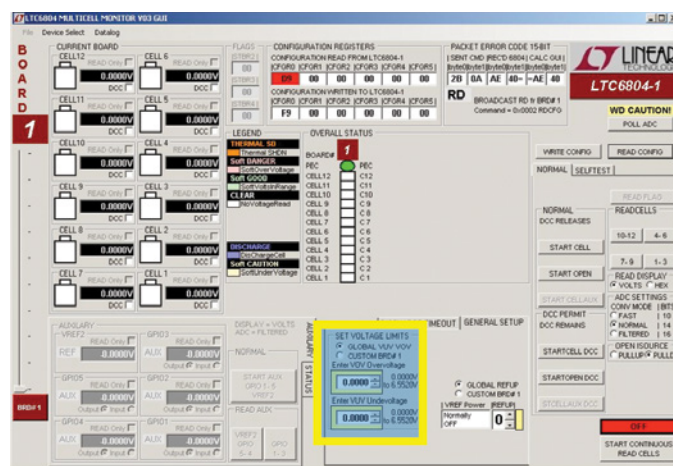

In the section labeled SET VOLTAGE LIMITS the user can enter voltage values for the overvoltage and undervoltage thresholds. The voltage value entered will be rounded to the actual value used by the LTC6804 and displayed in the box. The voltage ranges for these thresholds is 0V to 6.5520V.

These monitor thresholds can be applied globally to each and every cell in the system or customized for the cells connected to an individual board by clicking the desired option button. Individual boards are selected for programming by the left hand tabs in multiple board systems.

4: READ CELL VOLTAGES

The essential function of the LTC6804 is to measure and report the voltage on each battery cell. This is accomplished in two steps. First, click on the STARTCELL button. This commands an A/D conversion of all 12-cell voltages in the bit-resolution configured from the selected CONV MODE (Conversion Mode) in the ADC SETTINGS box. The actual

OPERATING THE CONTROL SCREEN

cell voltage measurements are displayed in groups of 3 when each command button inside the READ CELLS box is clicked.

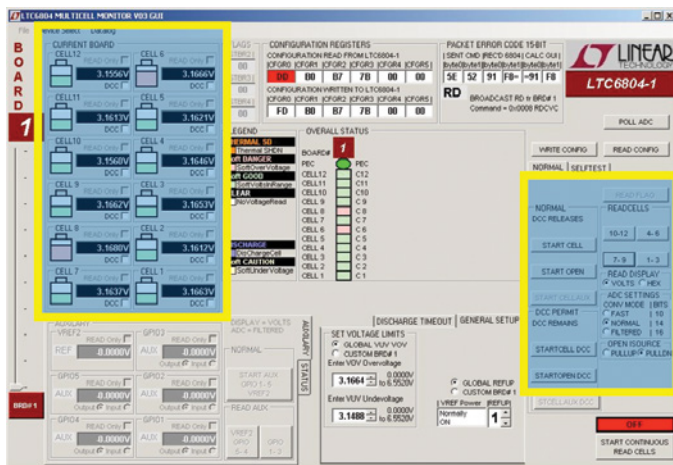

NOTE: Before initiating cell measurements, the user can set the bit-resolution by selecting the desired mode within the box ADC SETTINGS CONV MODE.

The READ DISPLAY box has options to display Cell Voltages in VOLTS or HEX. First select VOLTS or HEX then click on one of the command buttons inside READ CELLS box. Every time a command button inside the READ CELLS box is clicked; new data is downloaded from the board and displayed as selected in VOLTS or HEX.

5: DISCHARGE CELLS

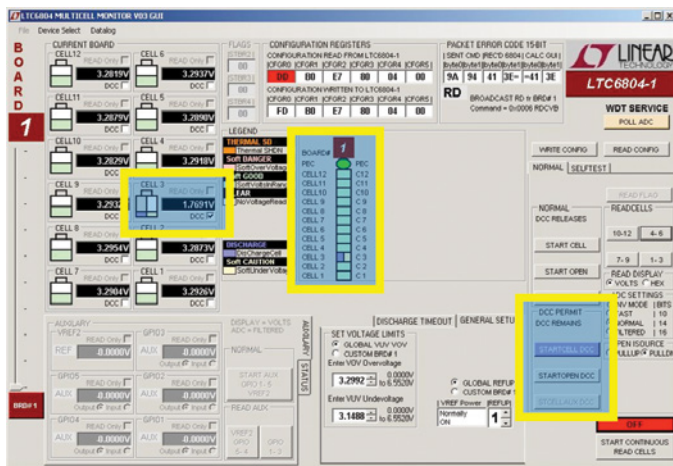

Another major feature of the LTC6804 is the ability to remove charge from individual cells. This can help to ensure even charge distribution over a stack of batteries. Across each cell connection, the DC1894B contains a P-channel MOSFET in series with a 33Ω resistor. When enabled, charge is pulled from the cell and energy is dissipated in the switch and resistor.

A check box is provided for each cell to be discharged. Checking this box (Cell 3 in the above example screenshot) and then writing this new configuration (with the WRITE CONFIG button) the cell will begin discharging.

NOTE: The discharge transistors are automatically turned off momentarily when measuring cell voltages via the STARTCELL command. This prevents voltage drop errors caused by the discharge current and ensures that the true cell voltage is obtained. The LTC6804 offers the option of keeping the discharge transistors on while measuring cell voltages, using the STARTCELL DCC command. This command button is illuminated blue when executed. In this mode, the lower voltage reading includes I*R errors introduced by cabling and connectors, as well as the load on the cell.

OTHER CONTROL FEATURES

Additional command buttons are provided on the control screen. The POLL ADC command button is used to determine if the ADC is busy (in the process of converting). The result of this command can be observed by monitoring the serial data output line of the SPI interface to the Bottom Port, J2. There is no indication provided on the control screen.

The START OPEN (WIRE) command button connects the built in open wire detection circuitry to all cells. This command must be followed by any command buttons inside the READ CELLS box click to see the result. The OPEN ISOURCE box provides options to use either PULLUP or PULLDOWN Open Wire Test Currents. An open wire connection to any cell will be indicated by an abnormally high

OPERATING THE CONTROL SCREEN

voltage measurement for the cell above the open wire and a near 0V measurement for the cell with the open wire.

CONTINUOUS OPERATION

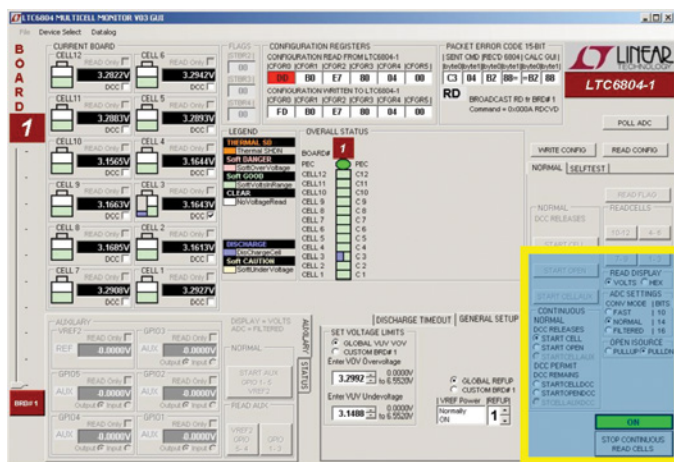

For convenience, the control panel allows for continuous operation of the DC1894B board. Using the command button labeled START CONTINUOUS READ CELLS the board control is placed in a continuous loop executing the following command sequence automatically:

Start cell voltage

Read cell voltage groups A (1-3) , B (4-6), C (7-9), and D (10-12)

Options available are the READ DISPLAY box, ADC SETTINGS box, OPEN ISOURCE box, and the CONTINUOUS box. The CONTINUOUS box allows the selection of STARTCELL, STARTOPEN, STARTCELL DCC, and STARTOPEN DCC commands to be executed during continuous operation. This is useful for monitoring the cell voltage measurements under different ADC Test Conditions.

All values are updated continually (update rate is ~500ms in FAST or NORMAL and ~750ms in FILTERED Conversion Mode). While running, the configuration can be changed on the fly. Simply changing a configuration item (Discharge cells for example) and clicking the WRITE CONFIG button will implement the new configuration and return to continuous operation.

A green box with the label ON in the lower right corner of the GUI indicates that the system is running continuously. A red box with the label OFF means that the system is stopped and waiting for a new command to be sent.

DATALOGGING OPERATION

The GUI program can datalog or store cell voltage results in a CSV (Comma Separated Value *.csv) file. This feature is useful for characterizing cell voltages over time. Datalogging operates similarly to continuous operation but has the added functionality of storing results in a CSV file.

1. At the upper left of the GUI, click on the Datalog Menu, then Enable Datalog.

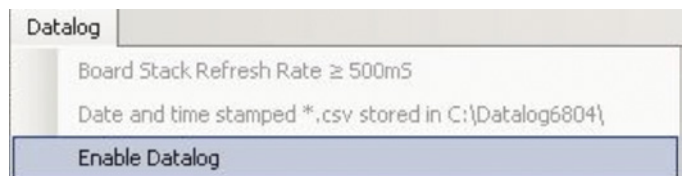

Datalog mode is enabled when a maroon box appears to the left of the START CONTINUOUS READ CELLS command button and the red box label changes from OFF to DATALOG OFF. Datalog mode is disabled when the maroon box disappears and the red box label reverts to OFF.

DEMO MANUAL DC1894B

OPERATING THE CONTROL SCREEN

NOTE: The *.csv filenames are based on the time created and are stored by default into the C:\Datalog6804\ folder. More details about datalogging are in the file AboutCurrentVersion.txt inside the GUI's installation folder (normally C:\Program Files\LTC\MultiCellBatteryMonitor\LTC6804).

2. Click on the START CONTINUOUS READ CELLS command button to start datalogging onto a new CSV file.



Elapsed Time = Total time of Datalog from start to finish.

Total Data Points = Total data points of Datalog from start to finish.

Refresh = Time in seconds (s) between each Read Cells command; also known as Sample or Update Rate.

3. Click on the STOP CONTINUOUS READ CELLS command button to stop datalogging and close the CSV file.

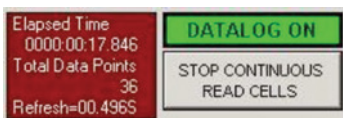

4. The CSV file is ready to view. Go to C:\Datalog6804\ folder and open file.

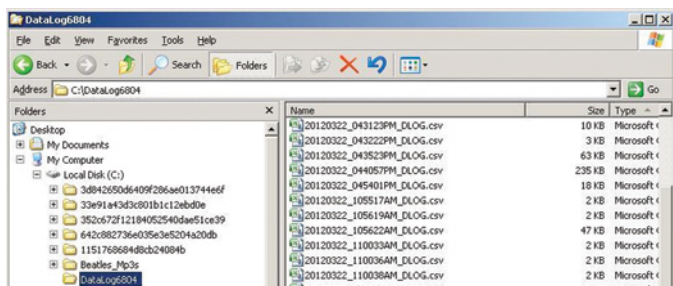

5. View the CSV file in a compatible spreadsheet software program such as MS Excel.

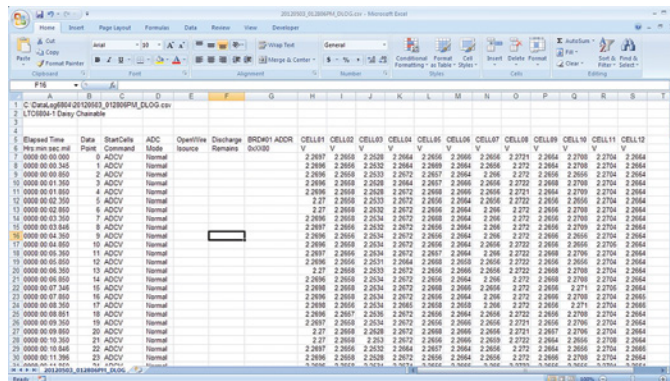

SOFTWARE ADJUSTMENTS

The GUI program can control up to ten boards on a stack.

1. Select the number of boards on the stack by sliding the track bar up or down; this slider is located on the far left side of GUI.

2. A tab will appear on the left edge of the control panel for each board on the stack. Clicking on any of these tabs will transfer control commands and data to and from the display screen to that selected board.

3. Select whether the ADC's voltage reference powered state (ref up) and over/undervoltage thresholds for each board are to be the same (GLOBAL) or different for each board (CUSTOM) and set the Ref Up and voltages accordingly.

COLOR CODED STATUS PANEL

The color coded status panel will expand to include all boards connected in a stack. Each small square in this array represents an individual battery in the stack of boards. The intent of this display is to provide a way to see the status of all cells at a glance. The significance of the colors used is explained in the legend on the screen.

OPERATING THE CONTROL SCREEN

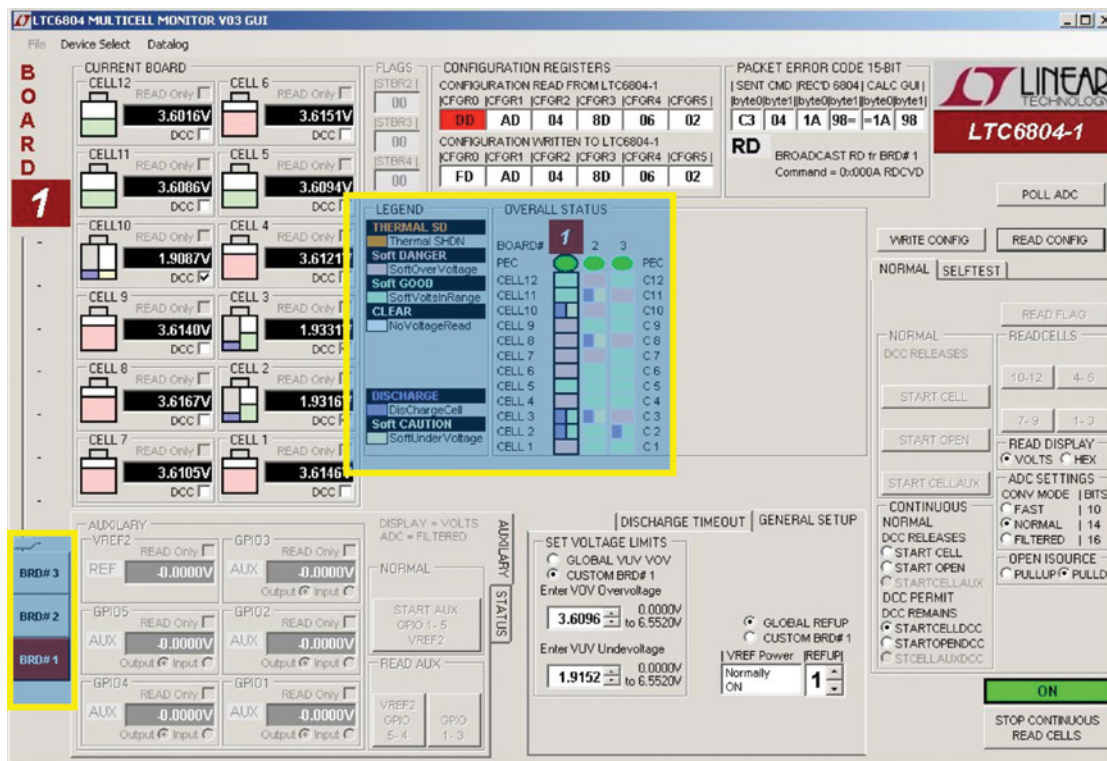

COMMANDS SUPPORTED (V03 VERSION)

POLLADC

WRITE CONFIG (REFUP, VUV, VOV, Discharge selected cells)

READ CONFIG

START CELL and OPEN WIRE conversions with and without discharge connected (ADC Settings: Conversion Mode, Open Wire Test Current (Open Isource))

READ CELL GROUPS (A, B, C and D. Read Volts/Hex)

START CONTINUOUS read all cells every 500ms.

COMMANDS NOT SUPPORTED (V03 VERSION)

SELFTEST

READ FLAGS

GPIO FUNCTIONS

For the latest software, contact your local LTC sales office.

DEMO MANUAL DC1894B

PARTS LIST

ITEM	QTY	REFERENCE	PART DESCRIPTION	MANUFACTURER/PART NUMBER
Required Circuit Components				
1	0	C1, C2, C3, C4, C5, C6, C7, C8, C9, C10, C11, C12, C14, C15	CAP., 0805, OPT	
2	2	C13, C23	CAP, 0805 100nF 10% 100V X7R	MURATA, GCM21BR72A104KA37
3	0	C16, C18, R65, R66	CAP., 1206, OPT	
4	4	C17, C20, C21, C22	CAP, 0603 1µF 10% 16V X7R	MURATA, GCM188R71C105KA64D
5	1	C19	CAP, 0603 100nF 10% 25V X7R	MURATA, GCM188R71E104KA57D
6	13	C24, C25, C26, C27, C28, C29, C30, C31, C32, C33, C34, C35, C36	CAP, 0603 10nF 10% 25V X7R	MURATA, GRM188R71E103KA01
7	1	D2	DIODE, SHOTTKY	DIODES INC., BAT46W-7-F
8	9	E1-E8, E10	TURRET	MILL MAX, 2308-2-00-80-00-00-07-0
9	4	JP1, JP2, JP3, JP4	HEADER, 3-PIN, 2mm	SAMTEC, TMM-103-02-L-S
10	4	XJP8, XJP9, XJP10, XJP11	SHUNT	SAMTEC, 2SN-BK-G
11	1	J1	HEADER, 1X16 3.5mm, HORIZ.	WEIDMULLER, 1761682001
12	1	J2	HEADER, 2X7 2mm	MOLEX, 87831-1420
13	2	J3, J4	CONNECTOR RJ45, CACE CODE 00779	TE CONNECTIVITY, 5406298-1-ND
14	12	LED1, LED2, LED3, LED4, LED5, LED6, LED7, LED8, LED9, LED10, LED11, LED12	LED, 0603 GREEN	LITE-ON, LTST-C190KGKT
15	1	P1	CONN. MATING 1X16 3.5mm HORZ	WEIDMULLER, 1615770000
16	12	Q1, Q2, Q3, Q4, Q5, Q6, Q7, Q8, Q9, Q10, Q11, Q12	XSTR, MOSFET, P-CHANNEL	INFINEON, BSS308PE
17	1	Q13	XSTR, NPN, SOT223	CENTRAL SEMI., CZT5551
18	15	R1, R2, R3, R4, R5, R6, R7, R8, R9, R10, R11, R12, R49, R56, R64	RES., CHIP, 100Ω 1% 0603	VISHAY, CRCW0603100RFKEA
19	12	R13, R14, R15, R16, R17, R18, R19, R20, R21, R22, R23, R24	RES., CHIP, 3.3k, 5% 0603	VISHAY, CRCW06033K30JNEA
20	12	R25, R26, R27, R28, R29, R30, R31, R32, R33, R34, R35, R36	RES., CHIP, 475Ω, 1% 0603	VISHAY, CRCW0603475RFKEA
21	12	R37, R38, R39, R40, R41, R42, R43, R44, R45, R46, R47, R48	RES., CHIP, 33Ω, 1% 2512	VISHAY, CRCW251233R0FKEG
22	2	R50, R51	RES., CHIP, 110Ω 1% 0603	VISHAY, CRCW0603110RFKEA
23	2	R52, R53	RES., CHIP, 1k, 1% 0603	VISHAY, CRCW06031K00FKEA
24	5	R54, R55, R62, R71, R72	RES., CHIP, 1M, 1% 0603	VISHAY, CRCW06031M00FKEA
25	2	R57, R58	RES., CHIP, 4.99Ω, 1% 0603	VISHAY, CRCW06034R99FKEA
26	1	R61	RES., CHIP, 0Ω, 1% 0603	VISHAY, CRCW06030000Z0EA
27	2	R63, R73	RES., CHIP, 0603 OPT	
28	1	R67	RES., CHIP, 10k, 1% 0603	VISHAY, CRCW060310K0FKEA
29	1	R68	RES, 0603 10k, NTC, 1% 1/10W	MURATA, NCP18XH103F03RB
30	2	R69, R70	RES., CHIP, 22k, 1% 0603	VISHAY, CRCW060322K0FKEA
31	1	T1	TRANS., TG110-AE050N5	HALO ELECTRONIC, TG110-AE050N5
32	1	U1	IC, BATTERY MONITOR, SSOP-48, 5.3mm	LINEAR TECH., LTC6804IG-1
33	1	U2	IC, 24AA01, SOT23-5, MARKING CODE B1	MICROCHIP TECH., 24AA01
34	1	U3	IC, 24LC025-I/ST	MICROCHIP TECH., 24LC025-I/ST
35	1	MH1, MH2, MH3, MH4	STANDOFF, SNAP ON	KEYSTONE_8831

dc1894bfa

SCHEMATIC DIAGRAM

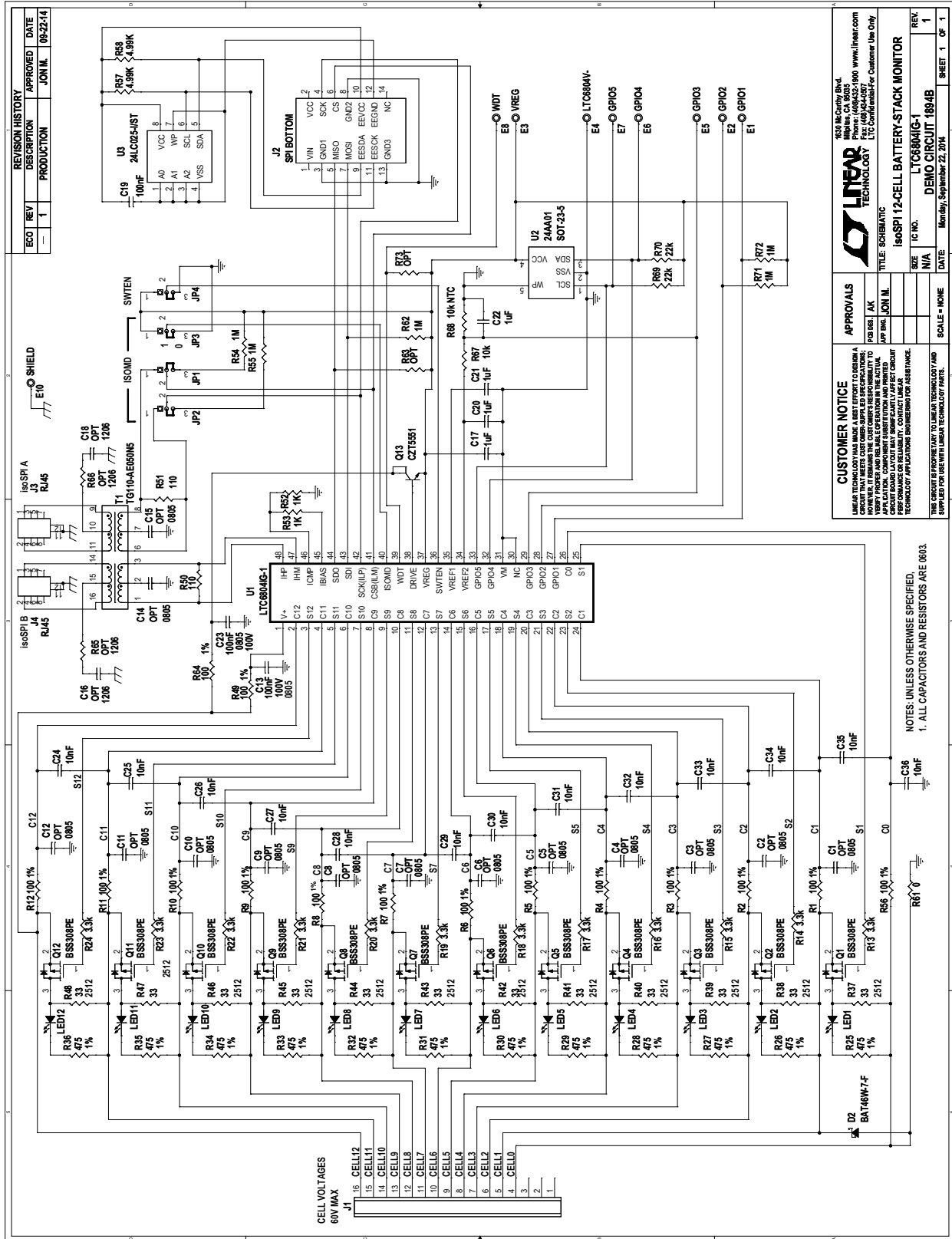

DEMO MANUAL DC1894B

DEMONSTRATION BOARD IMPORTANT NOTICE

Linear Technology Corporation (LTC) provides the enclosed product(s) under the following **AS IS** conditions:

This demonstration board (DEMO BOARD) kit being sold or provided by Linear Technology is intended for use for **ENGINEERING DEVELOPMENT OR EVALUATION PURPOSES ONLY** and is not provided by LTC for commercial use. As such, the DEMO BOARD herein may not be complete in terms of required design-, marketing-, and/or manufacturing-related protective considerations, including but not limited to product safety measures typically found in finished commercial goods. As a prototype, this product does not fall within the scope of the European Union directive on electromagnetic compatibility and therefore may or may not meet the technical requirements of the directive, or other regulations.

If this evaluation kit does not meet the specifications recited in the DEMO BOARD manual the kit may be returned within 30 days from the date of delivery for a full refund. **THE FOREGOING WARRANTY IS THE EXCLUSIVE WARRANTY MADE BY THE SELLER TO BUYER AND IS IN LIEU OF ALL OTHER WARRANTIES, EXPRESSED, IMPLIED, OR STATUTORY, INCLUDING ANY WARRANTY OF MERCHANTABILITY OR FITNESS FOR ANY PARTICULAR PURPOSE. EXCEPT TO THE EXTENT OF THIS INDEMNITY, NEITHER PARTY SHALL BE LIABLE TO THE OTHER FOR ANY INDIRECT, SPECIAL, INCIDENTAL, OR CONSEQUENTIAL DAMAGES.**

The user assumes all responsibility and liability for proper and safe handling of the goods. Further, the user releases LTC from all claims arising from the handling or use of the goods. Due to the open construction of the product, it is the user's responsibility to take any and all appropriate precautions with regard to electrostatic discharge. Also be aware that the products herein may not be regulatory compliant or agency certified (FCC, UL, CE, etc.).

No License is granted under any patent right or other intellectual property whatsoever. **LTC assumes no liability for applications assistance, customer product design, software performance, or infringement of patents or any other intellectual property rights of any kind.**

LTC currently services a variety of customers for products around the world, and therefore this transaction **is not exclusive**.

Please read the DEMO BOARD manual prior to handling the product. Persons handling this product must have electronics training and observe good laboratory practice standards. **Common sense is encouraged.**

This notice contains important safety information about temperatures and voltages. For further safety concerns, please contact a LTC application engineer.

Mailing Address:

Linear Technology
1630 McCarthy Blvd.
Milpitas, CA 95035

Copyright © 2004, Linear Technology Corporation