



WTB4S-3N2232
W4S-3

PHOTOELECTRIC SENSORS

SICK
Sensor Intelligence.



Illustration may differ



Ordering information

| Type | Part no. |
|--------------|----------|
| WTB4S-3N2232 | 1051872 |

Other models and accessories → www.sick.com/W4S-3

Detailed technical data

Features

| | |
|--|--|
| Sensor/ detection principle | Photoelectric proximity sensor, Background suppression |
| Dimensions (W x H x D) | 12.2 mm x 41.8 mm x 17.3 mm |
| Housing design (light emission) | Rectangular |
| Sensing range max. | 4 mm ... 120 mm ¹⁾ |
| Sensing range | 10 mm ... 120 mm ¹⁾ |
| Type of light | Visible red light |
| Light source | PinPoint LED ²⁾ |
| Light spot size (distance) | Ø 2.5 mm (50 mm) |
| Wave length | 650 nm |
| Adjustment | Single teach-in button |

¹⁾ Object with 90 % reflectance (referred to standard white, DIN 5033).

²⁾ Average service life: 100,000 h at T_J = +25 °C.

Mechanics/electronics

| | |
|--|---|
| Supply voltage | 10 V DC ... 30 V DC ¹⁾ |
| Ripple | < 5 V _{pp} ²⁾ |
| Power consumption | 20 mA ³⁾ |
| Switching output | NPN |
| Output function | Complementary |
| Switching mode | Light/dark switching |
| Output current I_{max.} | ≤ 100 mA |
| Response time | < 0.5 ms ⁴⁾ |
| Switching frequency | 1,000 Hz ⁵⁾ |
| Connection type | Male connector M8, 4-pin |
| Circuit protection | A ⁶⁾ C ⁷⁾ D ⁸⁾ |
| Protection class | III |
| Weight | 30 g |
| Housing material | Plastic, ABS |
| Optics material | Plastic, PMMA |
| Enclosure rating | IP67 IP66 |
| Ambient operating temperature | -40 °C ... +60 °C |
| Ambient storage temperature | -40 °C ... +75 °C |
| UL File No. | NRKH.E181493 & NRKH7.E181493 |

1) Limit values.

2) May not exceed or fall below U_v tolerances.

3) Without load.

4) Signal transit time with resistive load.

5) With light/dark ratio 1:1.

6) A = V_S connections reverse-polarity protected.

7) C = interference suppression.

8) D = outputs overcurrent and short-circuit protected.

Classifications

| | |
|-----------------------|----------|
| ECl@ss 5.0 | 27270904 |
| ECl@ss 5.1.4 | 27270904 |
| ECl@ss 6.0 | 27270904 |
| ECl@ss 6.2 | 27270904 |
| ECl@ss 7.0 | 27270904 |
| ECl@ss 8.0 | 27270904 |
| ECl@ss 8.1 | 27270904 |
| ECl@ss 9.0 | 27270904 |
| ETIM 5.0 | EC002719 |
| ETIM 6.0 | EC002719 |
| UNSPSC 16.0901 | 39121528 |

Connection diagram

Cd-083

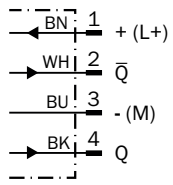

Characteristic curve

WTB4S-3, 120 mm

% of sensing distance

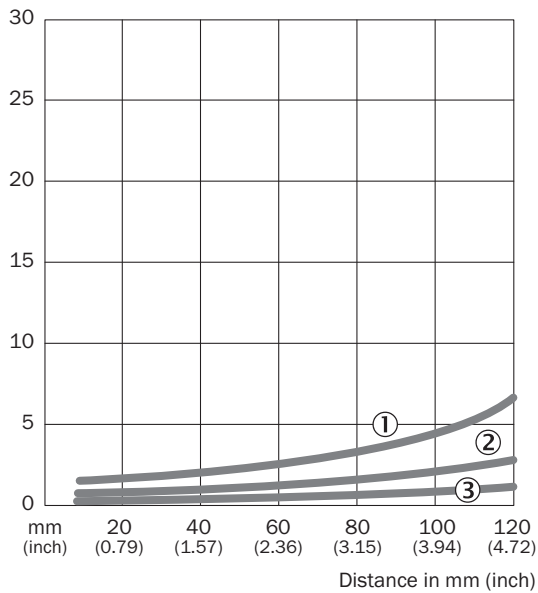

- ① Sensing range on black, 6% remission
- ② Sensing range on gray, 18 % remission
- ③ Sensing range on white, 90% remission

Sensing range diagram

WTB4S-3, 120 mm

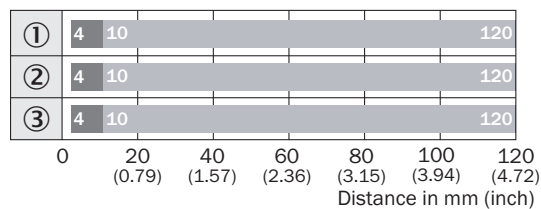

■ Sensing range max. ■ Sensing range

- ① Sensing range on black, 6% remission
- ② Sensing range on gray, 18 % remission
- ③ Sensing range on white, 90% remission

Dimensional drawing (Dimensions in mm (inch))

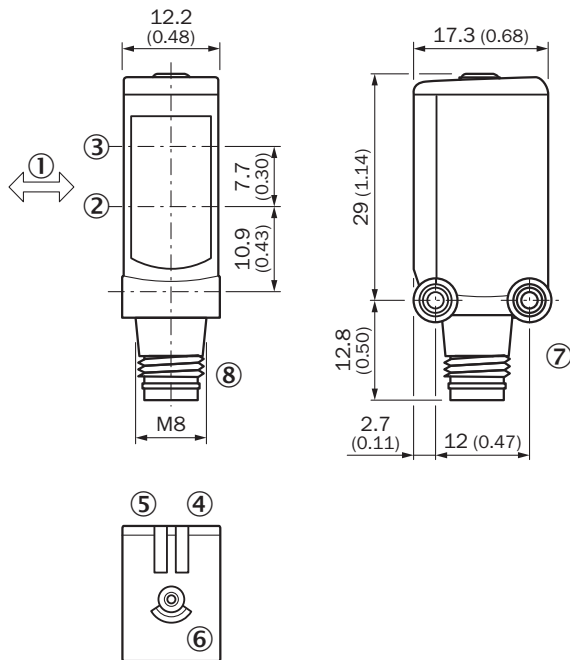

WTB4S-3, Single teach-in button







- ① Standard direction of the material being detected
- ② Optical axis, receiver
- ③ Optical axis, sender
- ④ LED indicator green: Supply voltage active
- ⑤ LED indicator yellow: Status of received light beam
- ⑥ Teach-in button
- ⑦ Threaded mounting hole M3
- ⑧ Connection

Recommended accessories

Other models and accessories → www.sick.com/W4S-3

| | Brief description | Type | Part no. |
|---|--|-------------|----------|
| Universal bar clamp systems | | | |
|  | Plate N08 for universal clamp bracket, Zinc plated steel (sheet), Zinc die cast (clamping bracket), Universal clamp (5322626), mounting hardware | BEF-KHS-N08 | 2051607 |
| Device protection (mechanical) | | | |
|  | Safety bracket for floor mounting, Stainless steel 1.4571, mounting hardware included | BEF-SW-W4S | 2051497 |

| | Brief description | Type | Part no. |
|---|--|--------------------|-----------------|
| Plug connectors and cables | | | |
|  | Head A: female connector, M8, 4-pin, straight, A-coded Head B: Flying leads Cable: Sensor/actuator cable, PVC, unshielded, 2 m | YF8U14-020VA3XLEAX | 2095888 |
| | Head A: female connector, M8, 4-pin, straight, A-coded Head B: Flying leads Cable: Sensor/actuator cable, PVC, unshielded, 5 m | YF8U14-050VA3XLEAX | 2095889 |
|  | Head A: female connector, M8, 4-pin, angled, A-coded Head B: Flying leads Cable: Sensor/actuator cable, PVC, unshielded, 2 m | YG8U14-020VA3XLEAX | 2095962 |
| | Head A: female connector, M8, 4-pin, angled, A-coded Head B: Flying leads Cable: Sensor/actuator cable, PVC, unshielded, 5 m | YG8U14-050VA3XLEAX | 2095963 |
|  | Head A: female connector, M8, 4-pin, straight Head B: - Cable: unshielded | DOS-0804-G | 6009974 |
|  | Head A: female connector, M8, 4-pin, angled Head B: - Cable: unshielded | DOS-0804-W | 6009975 |
|  | Head A: male connector, M8, 4-pin, straight Head B: - Cable: unshielded | STE-0804-G | 6037323 |

SICK AT A GLANCE

SICK is one of the leading manufacturers of intelligent sensors and sensor solutions for industrial applications. A unique range of products and services creates the perfect basis for controlling processes securely and efficiently, protecting individuals from accidents and preventing damage to the environment.

We have extensive experience in a wide range of industries and understand their processes and requirements. With intelligent sensors, we can deliver exactly what our customers need. In application centers in Europe, Asia and North America, system solutions are tested and optimized in accordance with customer specifications. All this makes us a reliable supplier and development partner.

Comprehensive services complete our offering: SICK LifeTime Services provide support throughout the machine life cycle and ensure safety and productivity.

For us, that is “Sensor Intelligence.”

WORLDWIDE PRESENCE:

Contacts and other locations –www.sick.com