

## FLAME click™

### 2. Soldering the headers

Before using your click™ board, make sure to solder 1x8 male headers to both left and right side of the board. Two 1x8 male headers are included with the board in the package.

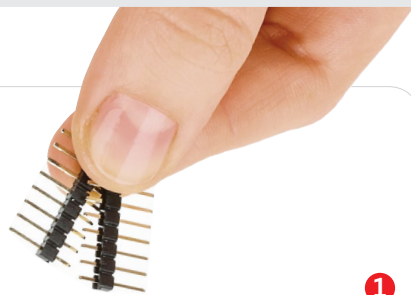

1

2

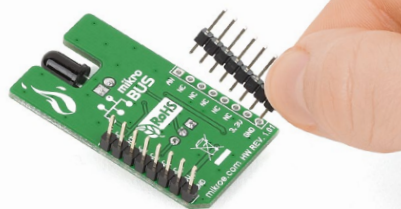

Turn the board upside down so that the bottom side is facing you upwards. Place shorter pins of the header into the appropriate soldering pads.

3

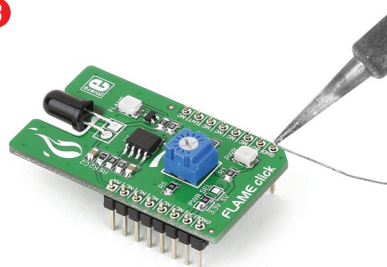

Turn the board upward again. Make sure to align the headers so that they are perpendicular to the board, then solder the pins carefully.

### 1. Introduction

Flame click™ is a fire detection solution. It carries a **PT334-6B NPN** silicon phototransistor that's covered in black epoxy and therefore sensitive only to infrared light. A **potentiometer** lets you calibrate the sensor for its specific environment. The board communicates with the target board microcontroller through the mikroBUS™ AN and INT pins. It can use both a 3.3V or a 5V power supply.

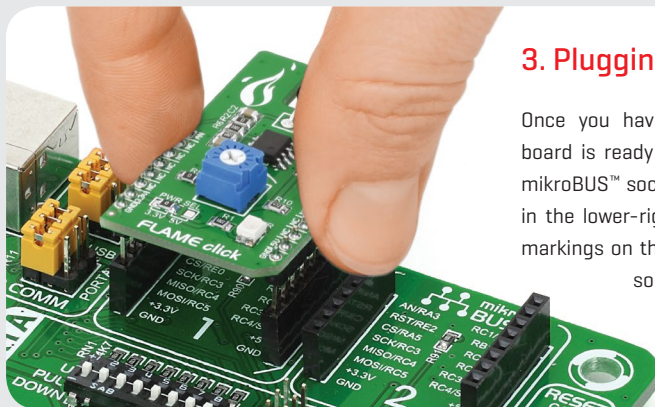

### 3. Plugging the board in

Once you have soldered the headers your board is ready to be placed into the desired mikroBUS™ socket. Make sure to align the cut in the lower-right part of the board with the markings on the silkscreen at the mikroBUS™ socket. If all the pins are aligned correctly, push the board

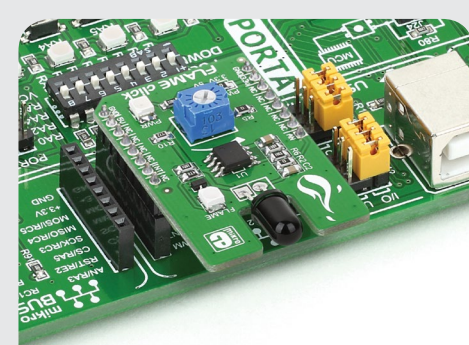

### 4. Essential features

Flame click™ can operate in two ways. It can output a continuous analog signal from the phototransistor, or send an interrupt to the target board MCU. The onboard potentiometer allows you to **set the exact threshold** that will **trigger the interrupt**. This will require some fine tuning as the **phototransistor will be sensitive to the surrounding thermal radiation**. Properly calibrated, flame click™ can be used in a variety of safety applications. Fire sensors based on phototransistors have a faster reaction time compared to smoke or heat detectors.

click™  
BOARD

[www.mikroe.com](http://www.mikroe.com)

FLAME click™ manual  
ver 1.01



0100000073636



## 5. Schematic

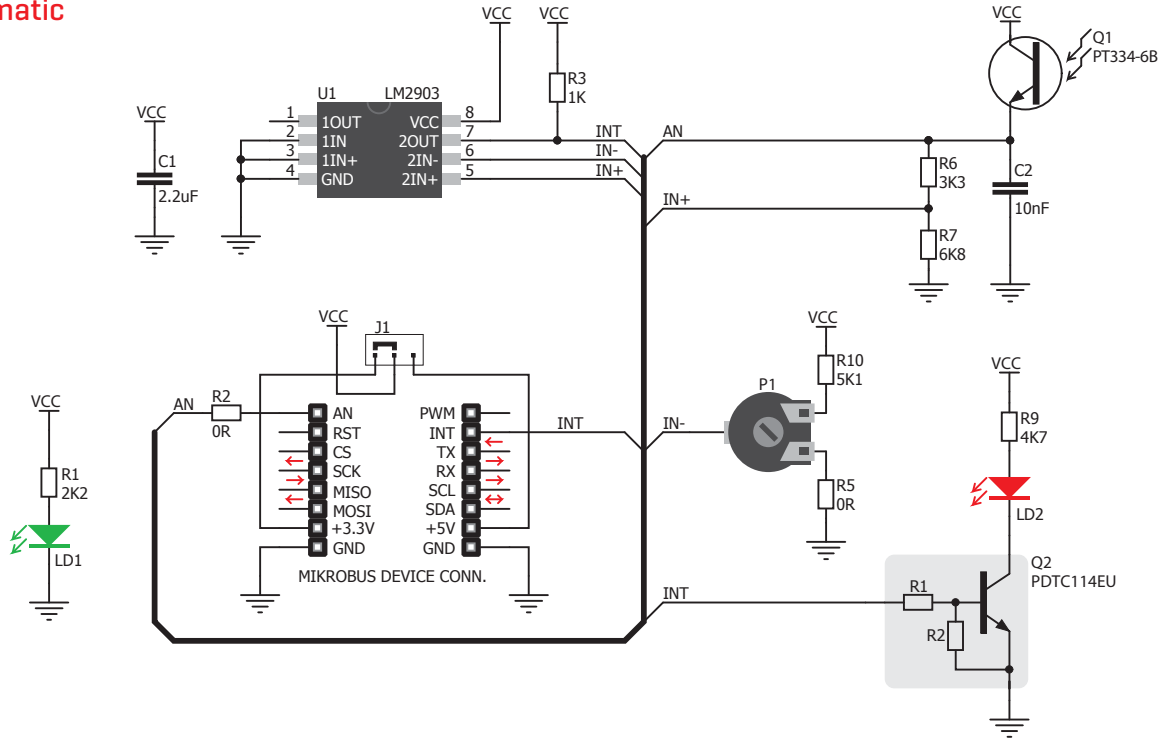

## 6. Dimensions

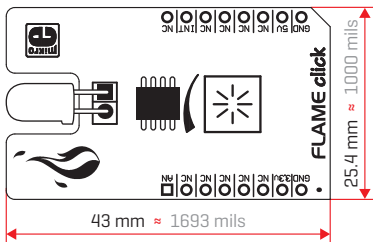

	mm	mils
LENGTH	43	1693
WIDTH	25.4	1000
HEIGHT	8.2	323

MikroElektronika assumes no responsibility or liability for any errors or inaccuracies that may appear in the present document. Specification and information contained in the present schematic are subject to change at any time without notice.

Copyright © 2015 MikroElektronika.  
All rights reserved.

## 7. SMD jumper



There is one zero-ohm SMD jumper J1 used to select whether 3.3V or 5V I/O

voltage level is used. Jumper **J1** is soldered in 3.3V position by default.

## 8. Code examples

Once you have done all the necessary preparations, it's time to get your click™ board up and running. We have provided examples for mikroC™, mikroBasic™ and mikroPascal™ compilers on our **Libstock** website. Just download them and you are ready to start.



## 9. Support

MikroElektronika offers **free tech support** [[www.mikroe.com/support](http://www.mikroe.com/support)] until the end of the product's lifetime, so if something goes wrong, we're ready and willing to help!

