



INSTRUCTION MANUAL

Models: H400
Anemometer

Table of Content

1. Product Introduction	3
1-1 Features	3
1-2 Applications	3
2. Safety Information	4
2-1 Cautions	4
2-2 Safety Symbols	4
3. Specifications.....	5
4. Operation Instructions.....	6
4-1 Unit Diagram	6
4-2 Air Velocity / Temperature Measurement	7
4-3 Data Hold / Data Record	7
5. Auto Power Off Disable	7
6. RS232 PC Serial Interface Information	7
7. Battery Replacement	9
8. Service Information	9
9. Warranty Information	10

To see all available accessories and downloadable software, please visit www.anaheimscientific.com

1-1 Features

- Measure both temperature and air flow
- Selectable °C & °F measurements
- Displays air flow in m/s, km/h, mph, knots & ft/min
- Two year warranty

2-2 Applications

- HVAC
- Energy audits
- Environmental experiments
- Building maintenance
- Agriculture





2. Safety Information

Read the following safety information carefully before attempting to operate or service the meter. Only qualified personnel should perform repairs or servicing not covered in this manual.

2-1 Cautions!

- **DO NOT** submerge the products mentioned in this manual in water or any other types of liquids.
- This product is not designed for use in medical applications. The product can only be used to measure body temperature simply for reference.

2-2 Safety Symbols

-  Dangerous, refer to this manual before using the meter.
-  Conforms to requirements of European Union and European Free Trade Association (EFTA).
-  Battery level is low.
-  Don't dispose this product as unsorted municipal waste.

This instrument conforms to the following standards:

EN61326: Electrical equipment for measurement, control and laboratory use.

IEC61000-4-2: Electrostatic discharge immunity test.

IEC61000-4-3: Radiated, radio-frequency, electromagnetic field immunity test.

IEC61000-4-8: Power frequency magnetic field immunity test.

3. Specifications

Display	5 Digit LCD with bar graph indicator	
Unit of Measurement	m/s (meters per second) km/h (kilometer per hour) ft/min (feet/per minute) knots (nautical miles per hour) mph (mile/h, miles per hour) Temp. (°C, °F) Data hold	
Sensor Structure	Air velocity sensor: Conventional twisted vane arm and low friction ball bearing design	
	Temperature sensor: Precision thermistor	
Sampling Time of Data Logger	Manual	Pushing the data logger button once will save data one time
	Auto	1, 2, 10, 30, 60, 600, 1800, 3600 seconds

Air Velocity

m/s	Range	0.4 - 25.0m/s
	Resolution	0.1m/s (≥ 10 m/s) 0.01m/s (< 10 m/s)
	Accuracy*	$\pm(2\% + 0.2$ m/s)
km/h	Range	1.4 - 90.0km/h
	Resolution	0.1km/h
	Accuracy*	$\pm(2\% + 0.2$ m/s)
mph	Range	0.9 - 55.9mph
	Resolution	0.1mph
	Accuracy*	$\pm(2\% + 0.2$ m/s)
knots	Range	0.8 - 48.8knots
	Resolution	0.1knots
	Accuracy*	$\pm(2\% + 0.2$ m/s)
ft/min	Range	80 - 4930ft/min
	Resolution	1ft/min
	Accuracy*	$\pm(2\% + 0.2$ m/s)

Temperature

Measuring Range	0° to 50°C / 32° to 122°F
Resolution	0.1°C / 0.1°F
Accuracy*	± 0.8 °C / 1.5°F

Over Range Indicator	" _ _ _ _ "
Data Hold	Display freeze
Memory	Saves MAX. or MIN values with recall
Sampling Time	Approximately 0.8 seconds
Power Off	Auto or manual control
Data Output	RS-232 Serial data output

Operating Environment	32° to 122°F (0° to 50°C), <80% R.H.
Power Supply	6 Pieces of DC 1.5V Batteries (UM4, AAA or equivalent)
Weight (approx.)	0.85lbs. (387g)
Dimensions (approx.)	Main instrument: 6.9 x 2.7 x 1.7" (174 x 68 x 42mm)
	Sensor probe diameter: 2.8" (72mm)
Included Accessories	Instruction manual, battery, carrying case

* = Note : Accuracy applicable in environments with RFI <3V/M with Hz <30MHz, and temperatures between 20°C to 26°C

Specifications and information are subject to change without notice

Please visit www.anaheimscientific.com for the most current product information.

4. Operation Instructions

4-1 Unit Diagram

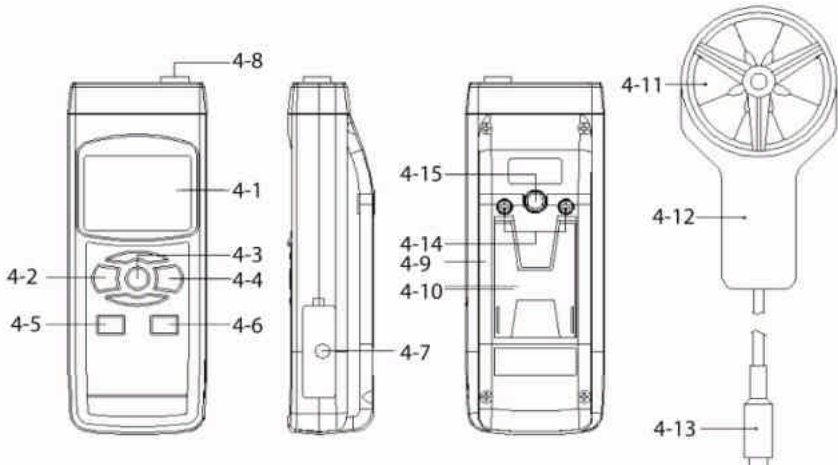

Fig. 1

4-1 LCD Display

4-2 Power Button

4-3 Hold Button

4-4 Record (MAX/MIN) Button

4-5 Unit Button

4-6 °C/°F Button

4-7 RS232 Socket

4-8 Probe Input Socket

4-9 Battery Compartment

4-10 Stand

4-11 Vane Probe Head

4-12 Probe Handal

4-13 Probe Plug

4-14 Battery Cover Screw

4-15 Tripod Screw Mount

4-2 Air Velocity / Temperature Measurement

1. Insert "Probe Plug" (4-13, Fig. 1) into the "Input Socket" (4-8, Fig. 1).
2. Power ON the meter by pressing the "Power Button" (4-2, Fig. 1).
3.
 - a. Select the desired air velocity unit of measure by pressing the "unit Button" (4-5, Fig. 1)
 - b. Select the desired temperature units by pressing the "C/F Button" (4-6, Fig. 1).
4. Hold the "Probe Handle" (4-12, Fig. 1), face the "Vane Probe Head" (4-11, Fig. 1) to the air flow source to be measured. The air velocity and temperature will both be displayed on the LCD.
5. **Important note:** Ensure the yellow dot mark faces into the air flow source to be measured.

4-3 Data Hold & Data Record

1. Data Hold
 - a. During a measurement, press the "Hold Button" (4-3, Fig. 1) to hold the displayed value on the LCD. The "HOLD" symbol will also be displayed on the LCD.
 - b. Pressing the "Hold Button" (4-3, Fig. 1) will release the data hold function.
2. Data Record (Max., Min.)
 - a. To record the maximum and minimum readings, press the "REC Button" (4-4, Fig. 1). The REC symbol will be displayed on the LCD. By pressing the "REC Button" (4-4, Fig. 1) you can toggle through the Max and Min values.
 - b. To delete the recorded values press and hold the "Hold Button" (4-3, Fig. 1) for about 3 seconds.
 - c. To stop using the REC function, press and hold the "REC Button" (4-4, Fig. 1) for at least 3 seconds.

5. Auto Power Off Disable

This instrument has a "Auto Power Off" function that can prolong battery life. The meter will shut off automatically if none of the buttons are pressed in approx. 10 min.

To disable this function, select the memory record function during a measurement by pressing the "REC. Button" (4-4, Fig. 1).

6. RS232 PC Serial Interface Information

This instrument has RS232 PC serial interface via a 3.5 mm terminal (4-12, Fig. 1).

The data output is a 16 digit stream which can be utilized for user's specific application.

A RS232 lead with the following connection will be required to link the instrument with the PC serial port.

Visit www.anaheimscientific.com to see any available downloadable software for your instrument.

Meter

PC
(9W 'D" Connector)

Center Pin.....Pin 4
(3.5 mm jack plug)
Ground/shield.....Pin 2

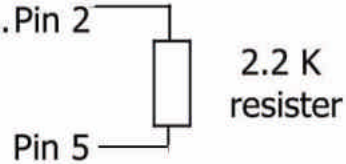

The 16 digit data stream will be displayed in the following format:			
D15	D14	D13	D12 D11 D10 D9 D8 D7 D6 D5 D4 D3 D2 D1D0
Each digit indicates the following status:			
D15	Start Word		
D14	4		
D13	When send the upper display data = 1		
	When send the upper display data = 2		
D12 & D11	Indicator for Display		
	°C = 01	°F = 02	m/s = 08
	Km/h = 10	ft/min = 11	mph = 12
	knot = 09		
D10	Polarity: 0 = Positive / 1 = Negative		
D9	Decimal Point (DP), position from right to left 0 = No DP, 1 = 1 DP, 2 = 2 DP, 3 = 3 DP		
D8 to D1	Display reading, D1 = LSD, D8 = MSD Example: If the display reading is 1234, then D8 to D1 is: 00001234		
D0	End Word		
RS232 Setting			
Baud Rate	9600		
Parity	No Parity		
Data bit #	8 Data bits		
Stop bit	1 Stop bit		

7. Battery Replacement

1. When the LCD display shows the  low battery symbol, It is necessary to replace the battery. The specifications listed for this instrument do not apply when the low battery symbol is displayed.
2. Open the “Battery Compartment” (4-9, Fig. 1) by first loosening the “Battery Cover Screws” (4-14, Fig. 1).
3. Replace the batteries with “good” batteries noting the correct polarity . Replace “Battery Compartment” (4-9, Fig. 1) and “Battery Cover Screws” (4-14, Fig. 1). Ensure the cover is securely fastened.

8. Service Information

Warranty Service: Please return the product in the original packaging with proof of purchase to the address below . Clearly state in writing the performance problem and return any leads, probes, connectors and accessories that you are using with the device.

Non-Warranty Service: Return the product in the original packaging to the address below . Clearly state in writing the performance problem and return any leads, probes, connectors and accessories that you are using with the device. Customers not on open account must include payment in the form of a money order or credit card. For the most current repair charges please visit www.anaheimscientific.com and click on “service/repair”.

Return all merchandise to Anaheim Scientific with pre-paid shipping. The flat-rate repair charge for Non-Warranty Service **does not** include return shipping. Return shipping to locations in North American is included for Warranty Service only. For overnight shipments and non-North American shipping fees please contact Anaheim Scientific.

Anaheim Scientific
22820 Savi Ranch Parkway
Yorba Linda, CA 92887
www.anaheimscientific.com
714-921-9095

Include with the returned instrument your complete return shipping address, contact name, phone number and description of problem .

9. Limited Two-Year Warranty

Anaheim Scientific warrants to the original purchaser that its products and the component parts thereof, will be free from defects in workmanship and materials for a period of two years from date of purchase from an authorized Anaheim Scientific distributor.

Anaheim Scientific will, without charge, repair or replace, at its option, defective product or component parts. Returned product must be accompanied by proof of the purchase date in the form of a sales receipt.

To obtain warranty coverage in the U.S.A., this product must be registered by completing the warranty registration form on www.anaheimscientific.com within fifteen (15) days of purchase.

Exclusions: This warranty does not apply in the event of misuse or abuse of the product or as a result of unauthorized alterations or repairs. The warranty is void if the serial number is altered, defaced or removed.

Anaheim Scientific shall not be liable for any consequential damages, including without limitation damages resulting from loss of use. Some states do not allow limitations of incidental or consequential damages. So the above limitation or exclusion may not apply to you.

This warranty gives you specific rights and you may have other rights, which vary from state-to-state.

Anaheim Scientific
22820 Savi Ranch Parkway
Yorba Linda, CA 92887
www.anaheimscientific.com
714-921-9095

Anaheim Scientific

22820 Savi Ranch Parkway

Yorba Linda, CA 92887

U.S.A.

www.anaheimscientific.com

Printed in Taiwan / Ver. 1.0/0606

© 2006 Anaheim Scientific Corporation