

General Description

The MIC862 is a dual low-power operational amplifier in an SOT23-8 package. It is designed to operate in the 2V to 5V range, rail-to-rail output, with input common-mode to ground. The MIC862 provides 3MHz gain-bandwidth product while consuming only a 31 μ A/channel supply current.

With low supply voltage and SOT23-8 packaging, MIC862 provides two channels as general-purpose amplifiers for portable and battery-powered applications. Its package provides the maximum performance available while maintaining an extremely slim form factor. The minimal power consumption of this IC maximizes the battery life potential.

Datasheets and support documentation are available on Micrel's website at: www.micrel.com.

Features

- SOT23-8 package
- 3MHz gain-bandwidth product
- 5MHz, -3dB bandwidth
- 31 μ A supply current
- Rail-to-rail output
- Ground sensing at input (common mode to GND)
- Drive large capacitive loads
- Unity gain stable

Applications

- Portable equipment
- Medical instruments
- PDAs
- Pagers
- Cordless phones
- Consumer electronics

Typical Application

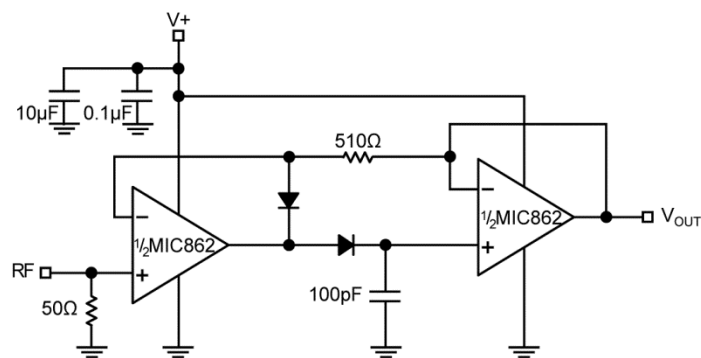

Peak Detector Circuit for AM Radio

Ordering Information

Part Number	Marking	Ambient Temperature Range	Package
MIC862TYM8	A34	-40° to +85°C	SOT23-8

Pin Configuration

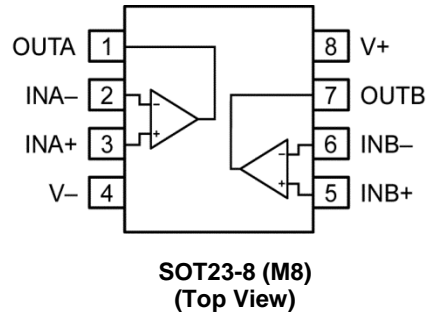

Pin Description

Pin Number	Pin Name	Pin Function
1	OUTA	Amplifier A output
2	INA-	Amplifier A inverting input
3	INA+	Amplifier A non-inverting input
4	V-	Negative supply
5	INB+	Amplifier B non-inverting input
6	INB-	Amplifier B inverting input
7	OUTB	Amplifier B output
8	V+	Positive supply

Absolute Maximum Ratings⁽¹⁾

Supply Voltage (V_{V+} to V_{V-}).....	+6.0V
Differential Input Voltage (V_{IN+} to V_{IN-}) ⁽³⁾	+6.0V
Input Voltage (V_{IN+} to V_{IN-}).....	$V_{V+} + 0.3V$, $V_{V-} - 0.3V$
Lead Temperature (soldering, 10s).....	260°C
Output Short-Circuit Current Duration.....	Indefinite
Operating Temperature.....	-40°C to +125°C
Storage Temperature (T_s).....	150°C
ESD Rating ⁽⁴⁾	ESD Sensitive

Operating Ratings⁽²⁾

Supply Voltage (V_+ to V_-)	+2.0V to +5.25V
Ambient Temperature (T_A)	-40°C to +85°C
Package Thermal Resistance	
θ_{JA} (Using 4 Layer PCB)	100°C/W
θ_{JC} (Using 4 Layer PCB)	70°C/W

Electrical Characteristics⁽⁵⁾

$V_+ = +2V$, $V_- = 0V$, $V_{CM} = V_+/2$; $R_L = 500k\Omega$ to $V_+/2$; $T_A = 25^\circ C$, **bold** values indicate $-40^\circ C \leq T_A \leq +85^\circ C$, unless noted.

Symbol	Parameter	Condition	Min.	Typ.	Max.	Units
V_{OS}	Input Offset Voltage		-6	0.1	6	mV
			-5	0.1	5	mV
	Differential Offset Voltage			0.5		mV
	Input Offset Voltage Temperature Coefficient			6		$\mu V/^\circ C$
I_B	Input Bias Current			10		pA
I_{OS}	Input Offset Current			5		pA
V_{CM}	Input Voltage Range (from V_-)	CMRR > 50dB	0.5	1		V
CMRR	Common-Mode Rejection Ratio	$0 < V_{CM} < 1V$	45	75		dB
PSRR	Power Supply Rejection Ratio	Supply voltage change of 2V to 2.7V	50	78		dB
A_{VOL}	Large-Signal Voltage Gain	$R_L = 5k\Omega$, $V_{OUT} = 1.4V_{PP}$	66	74		dB
		$R_L = 100k\Omega$, $V_{OUT} = 1.4V_{PP}$	75	89		dB
		$R_L = 500k\Omega$, $V_{OUT} = 1.4V_{PP}$	85	100		dB
V_{OUT}	Maximum Output Voltage Swing	$R_L = 5k\Omega$	V+ -80mV	$V_+ -55mV$		V
		$R_L = 500k\Omega$	V+ -3mV	$V_+ -1.4mV$		V
V_{OUT}	Minimum Output Voltage Swing	$R_L = 5k\Omega$		$V_- +14mV$	V- +20mV	V
		$R_L = 500k\Omega$		$V_- +0.85mV$	V- +3mV	V
GBW	Gain-Bandwidth Product	$R_L = 20k\Omega$, $C_L = 2pF$, $A_V = 11$		2.1		MHz
PM	Phase Margin	$R_L = 20k\Omega$, $C_L = 2pF$, $A_V = 11$		57		°
BW	-3dB Bandwidth	$R_L = 1M\Omega$, $C_L = 2pF$, $A_V = 1$		4.2		MHz
SR	Slew Rate	$R_L = 1M\Omega$, $C_L = 2pF$, $A_V = 1$ Positive Slew Rate = 1.5V/ μs		2		V/ μs
I_{SC}	Short-Circuit Output Current	Source	1.8	2.6		mA
		Sink	1.5	2.2		mA
I_S	Supply Current (per Op Amp)	No Load		27	43	μA
	Channel-to-Channel Crosstalk	Note 6		-100		dB

Notes:

- Exceeding the absolute maximum ratings may damage the device.
- The device is not guaranteed to function outside its operating ratings.
- Exceeding the maximum differential input voltage will damage the input stage and degrade performance. In particular, input bias current is likely to increase.
- Devices are ESD sensitive. Handling precautions are recommended. Human body model, 1.5k Ω in series with 100pF.
- Specification for packaged product only.
- DC signal referenced to input. Refer to Typical Characteristics graphs for AC performance.

Electrical Characteristics⁽⁵⁾ (Continued)

$V_+ = +2.7V$, $V_- = 0V$, $V_{CM} = V_+/2$; $R_L = 500k\Omega$ to $V_+/2$; $T_A = 25^\circ C$, **bold** values indicate $-40^\circ C \leq T_A \leq +85^\circ C$, unless noted.

Symbol	Parameter	Condition	Min.	Typ.	Max.	Units
V_{OS}	Input Offset Voltage		-6	0.1	6	mV
			-5	0.1	5	mV
	Differential Offset Voltage			0.5		mV
	Input Offset Voltage Temperature Coefficient			6		$\mu V/^\circ C$
I_B	Input Bias Current			10		pA
I_{OS}	Input Offset Current			5		pA
V_{CM}	Input Voltage Range (from V_-)	CMRR > 60dB	1	1.8		V
CMRR	Common-Mode Rejection Ratio	$0 < V_{CM} < 1.35V$	65	83		dB
PSRR	Power Supply Rejection Ratio	Supply voltage change of 2.7V to 3V	60	85		dB
A_{VOL}	Large-Signal Voltage Gain	$R_L = 5k\Omega$, $V_{OUT} = 2V_{PP}$	65	77		dB
		$R_L = 100k\Omega$, $V_{OUT} = 2V_{PP}$	80	90		dB
		$R_L = 500k\Omega$, $V_{OUT} = 2V_{PP}$	90	101		dB
GBW	Gain-Bandwidth Product	$R_L = 20k\Omega$, $C_L = 2pF$, $A_V = 11$		2.3		MHz
PM	Phase Margin	$R_L = 20k\Omega$, $C_L = 2pF$, $A_V = 11$		50		$^\circ$
BW	-3dB Bandwidth	$R_L = 1M\Omega$, $C_L = 2pF$, $A_V = 1$		4.2		MHz
SR	Slew Rate	$R_L = 1M\Omega$, $C_L = 2pF$, $A_V = 1$ Positive Slew Rate = $1.5V/\mu s$		3		$V/\mu s$
I_{SC}	Short-Circuit Output Current	Source	4.5	6.3		mA
		Sink	4.5	6.2		mA
I_S	Supply Current (per Op Amp)	No Load		28	45	μA
	Channel-to-Channel Crosstalk	Note 6		-120		dB

Electrical Characteristics⁽⁵⁾ (Continued)

V₊ = +5V, V₋ = 0V, V_{CM} = V₊/2; R_L = 500kΩ to V₊/2; T_A = 25°C, **bold** values indicate -40°C ≤ T_A ≤ +85°C, unless noted.

Symbol	Parameter	Condition	Min.	Typ.	Max.	Units
V _{OS}	Input Offset Voltage		-6	0.1	6	mV
			-5	0.1	5	mV
	Differential Offset Voltage			0.5		mV
	Input Offset Voltage Temperature Coefficient			6		μV/°C
I _B	Input Bias Current			10		pA
I _{OS}	Input Offset Current			5		pA
V _{CM}	Input Voltage Range (from V ₋)	CMRR > 60dB	3.5	4.1		V
CMRR	Common-Mode Rejection Ratio	0 < V _{CM} < 3.5V	60	87		dB
PSRR	Power Supply Rejection Ratio	Supply voltage change of 3V to 5V	60	92		dB
A _{VOL}	Large-Signal Voltage Gain	R _L = 5kΩ, V _{OUT} = 4.8V _{PP}	65	73		dB
		R _L = 100kΩ, V _{OUT} = 4.8V _{PP}	80	86		dB
		R _L = 500kΩ, V _{OUT} = 4.8V _{PP}	89	96		dB
V _{OUT}	Maximum Output Voltage Swing	R _L = 5kΩ	V+ -50mV	V+ -37mV		V
		R _L = 500kΩ	V+ -3mV	V+ -1.3mV		V
V _{OUT}	Minimum Output Voltage Swing	R _L = 5kΩ		V- +24mV	V- +40mV	V
		R _L = 500kΩ		V- +0.7mV	V- +3mV	V
GBW	Gain-Bandwidth Product	R _L = 20kΩ, C _L = 2pF, A _V = 11		3		MHz
PM	Phase Margin			45		°
BW	-3dB Bandwidth	R _L = 1MΩ, C _L = 2pF, A _V = 1		5		MHz
SR	Slew Rate	R _L = 1MΩ, C _L = 2pF, A _V = 1 Positive Slew Rate = 1.5V/μs		4		V/μs
I _{SC}	Short-Circuit Output Current	Source	17	23		mA
		Sink	18	27		mA
I _S	Supply Current (per Op Amp)	No Load		31	47	μA
	Channel-to-Channel Crosstalk	Note 6		-120		dB

Typical Characteristics

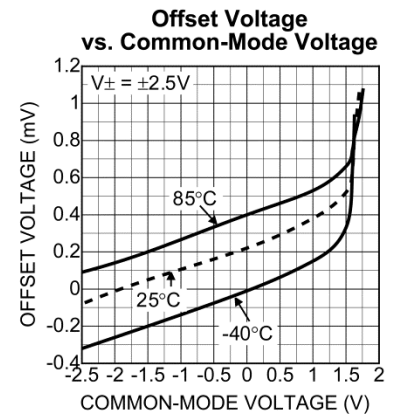
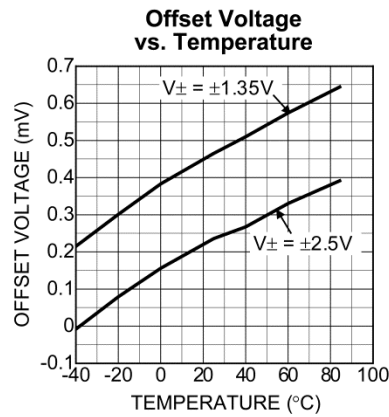
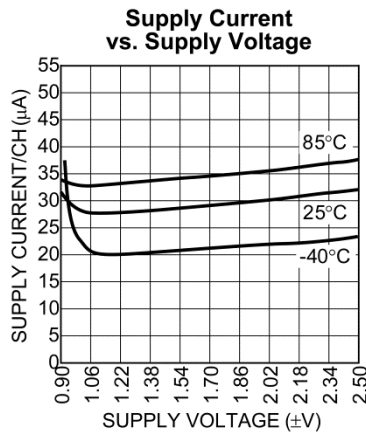
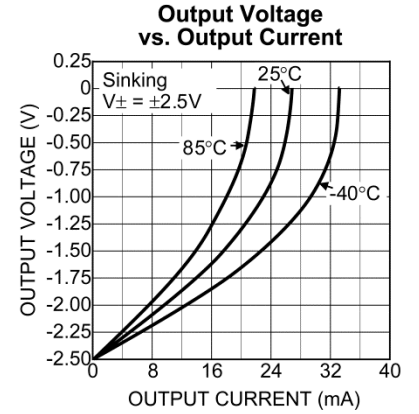
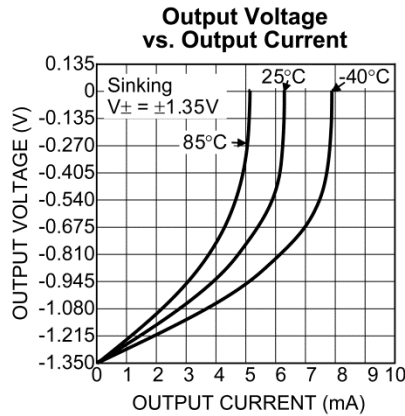
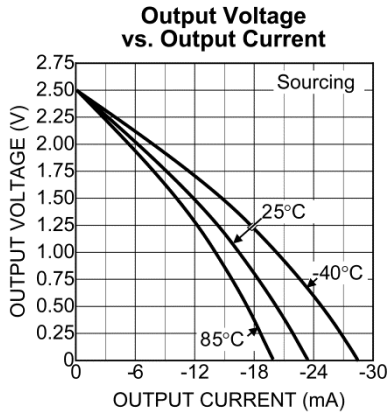
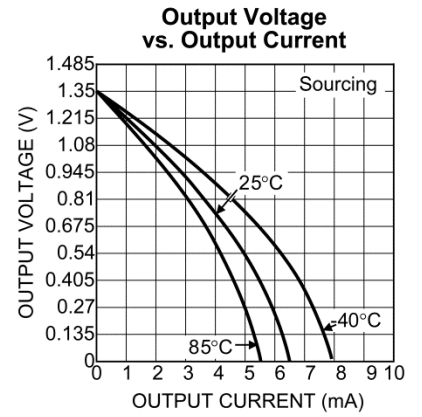
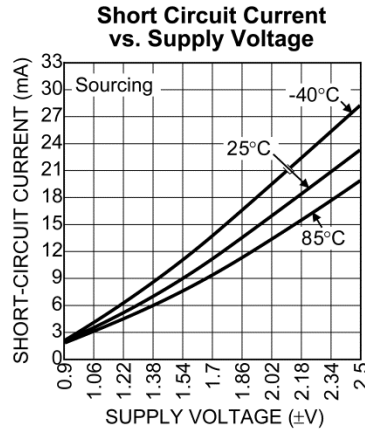
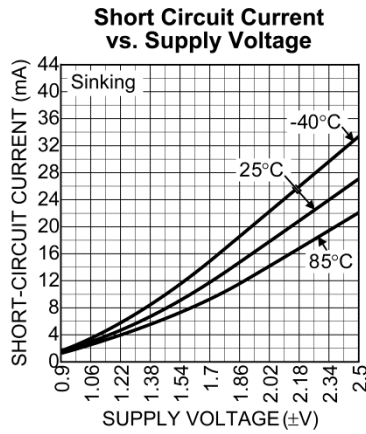

Typical Characteristics (Continued)

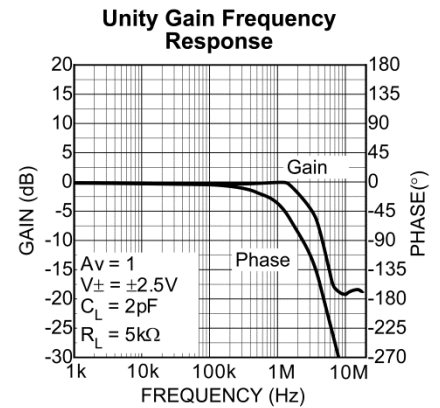
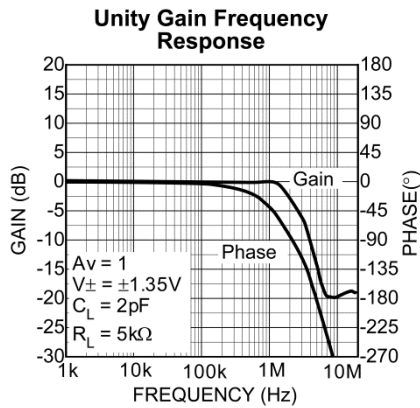
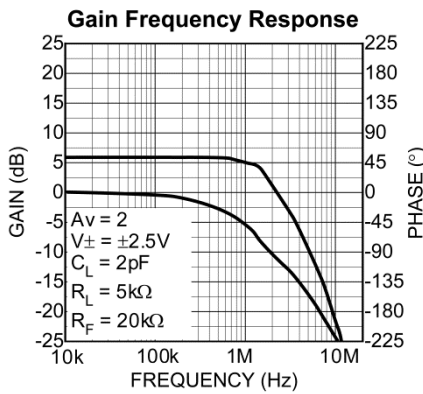
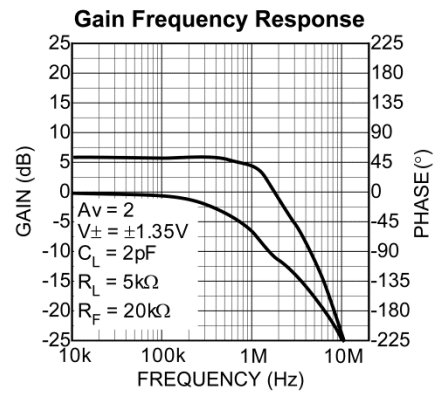
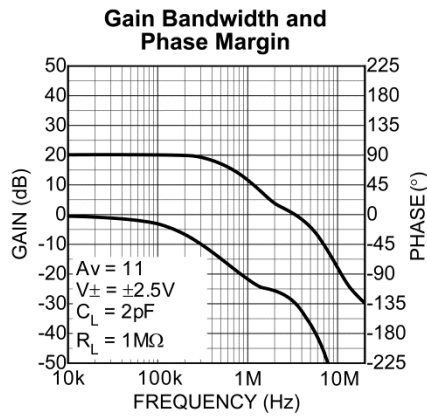
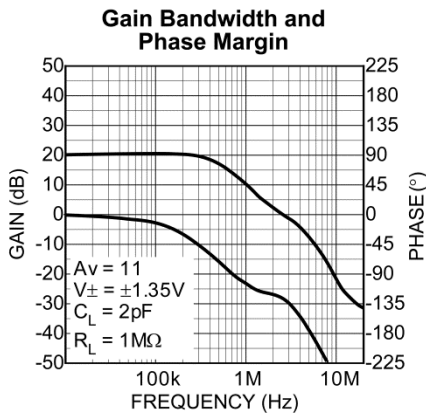
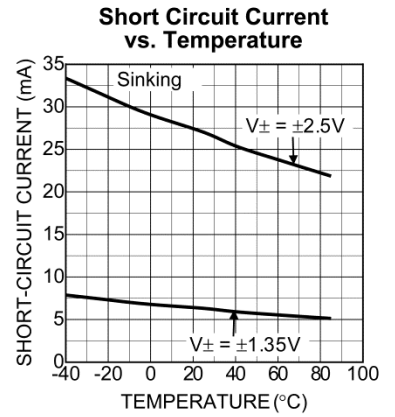
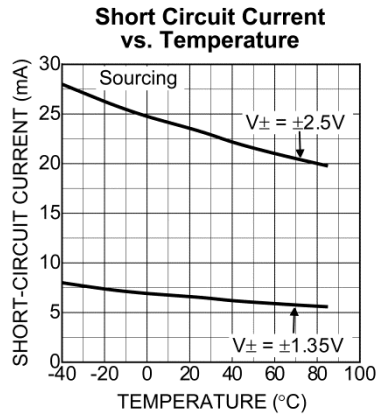
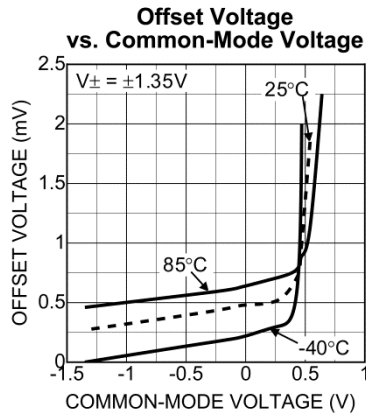

Typical Characteristics (Continued)

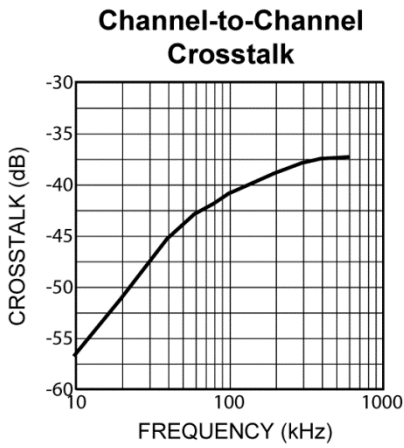
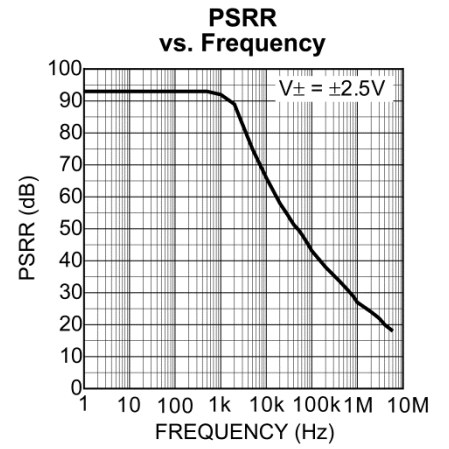
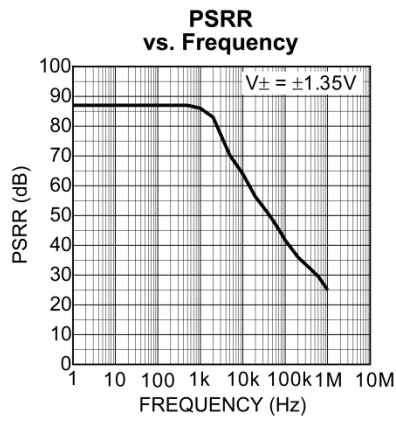
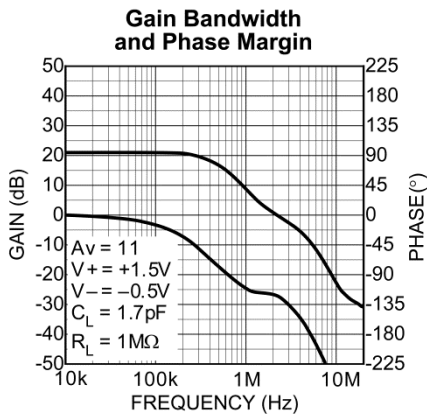

Functional Characteristics

Small Signal Response

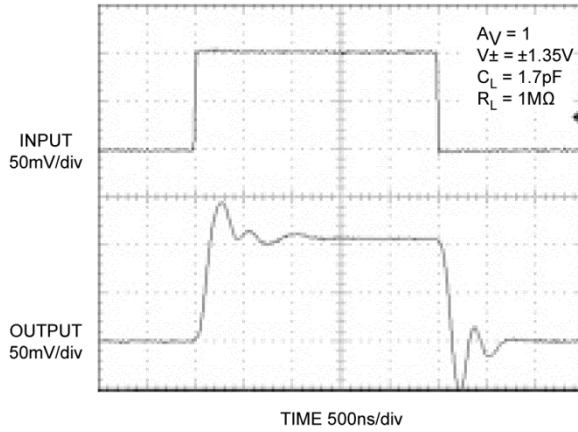

Small Signal Response

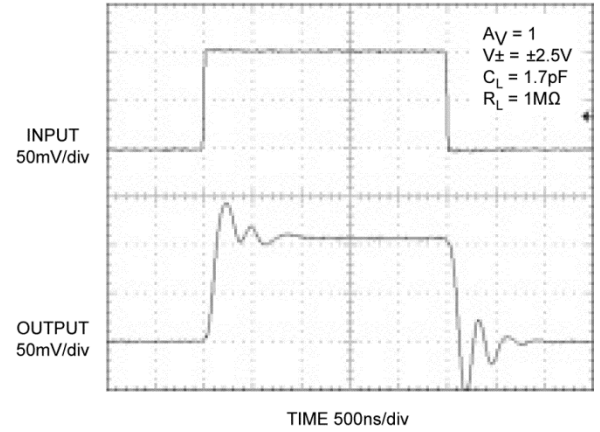

Small Signal Response

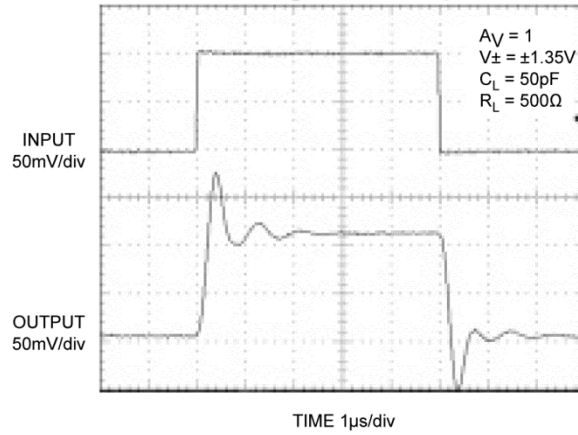

Small Signal Response

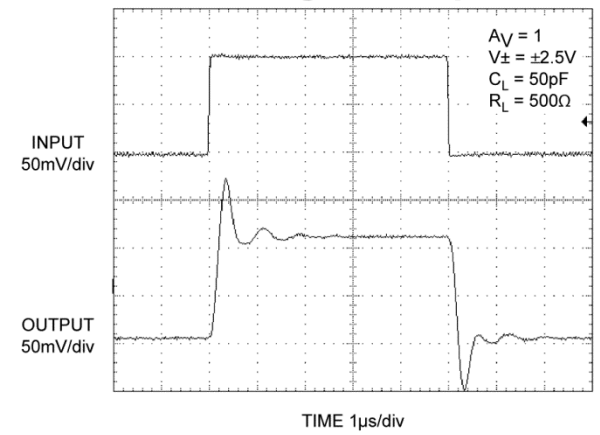

Small Signal Response

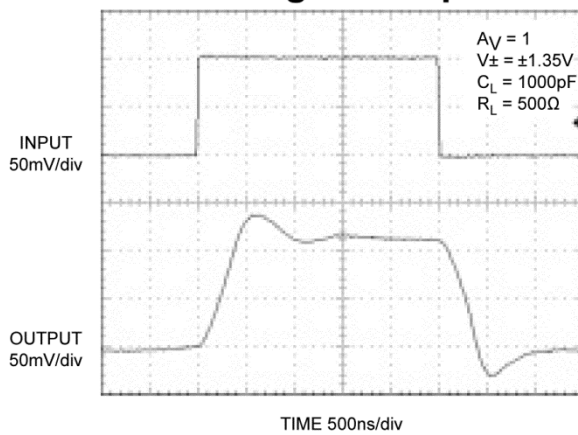

Small Signal Response

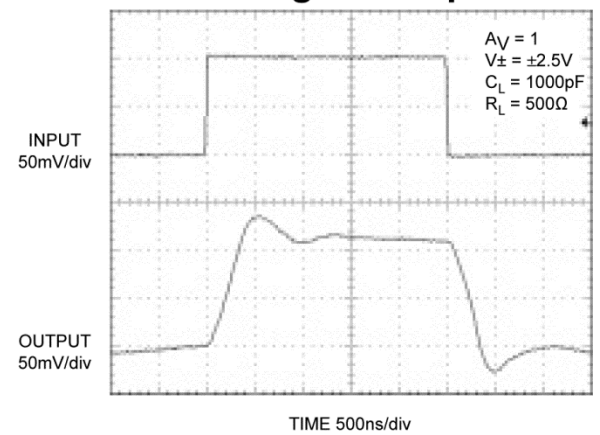

Functional Characteristics (Continued)

Small Signal Pulse Response

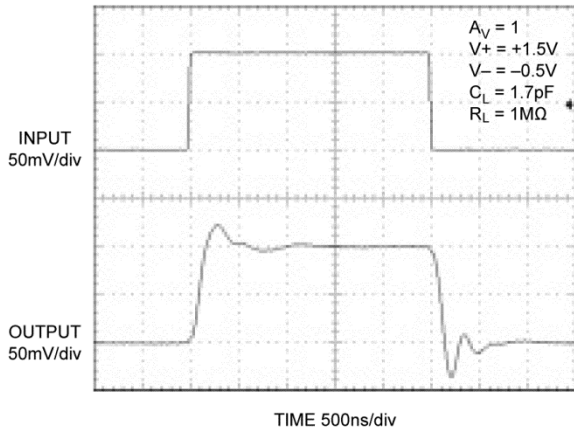

Large Signal Response

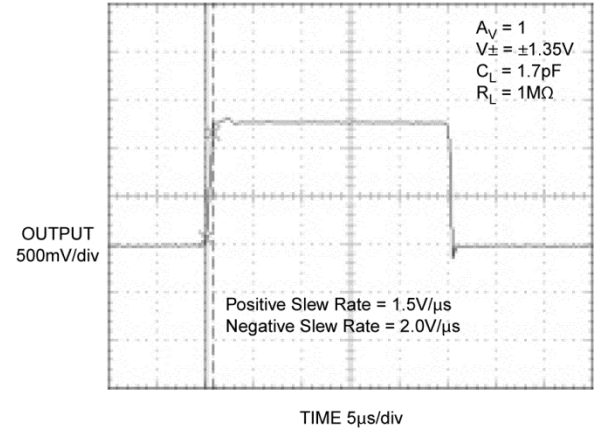

Large Signal Response

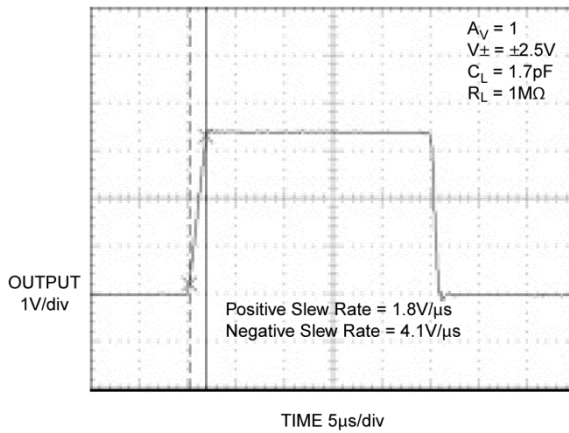

Large Signal Response

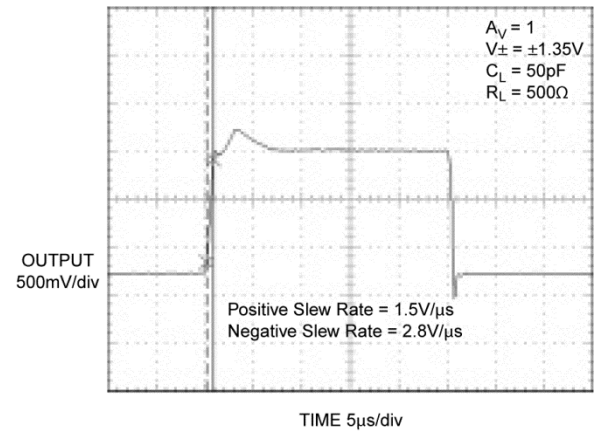

Large Signal Response

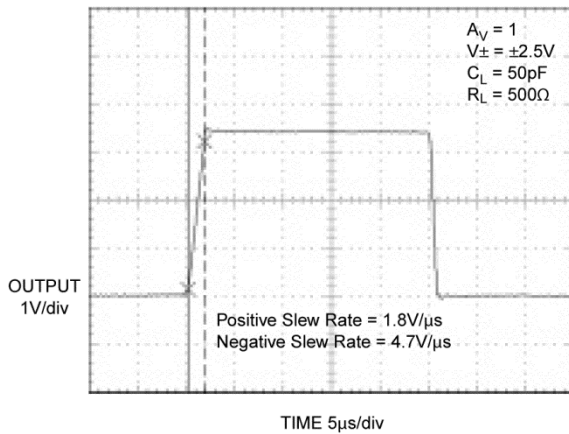

Large Signal Pulse Response

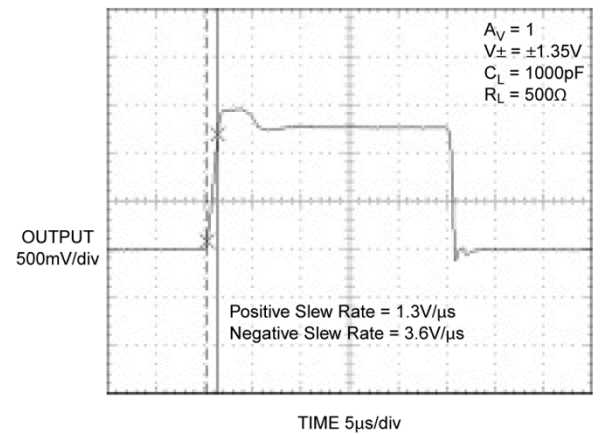

Functional Characteristics (Continued)

Large Signal Pulse Response

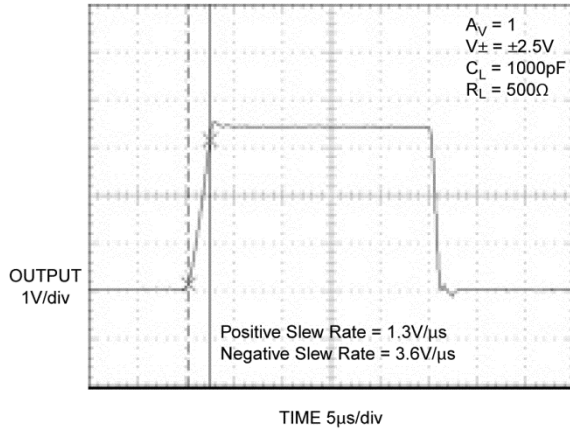

Large Signal Pulse Response

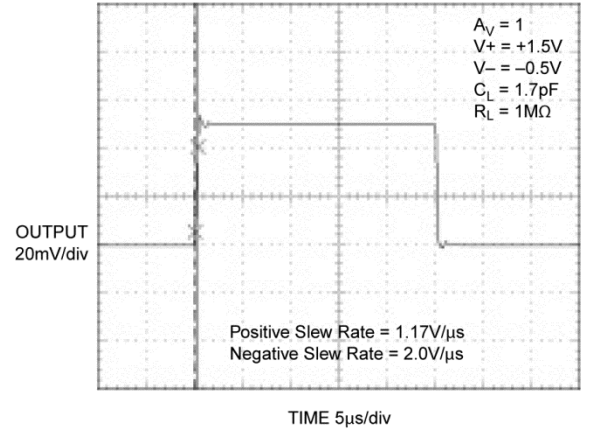

Rail-to-Rail Operation

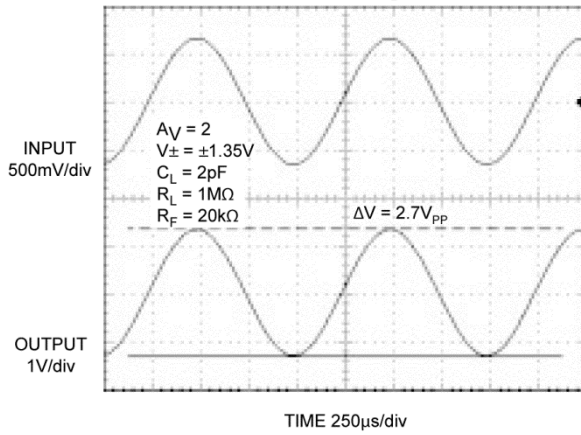

Rail-to-Rail Operation

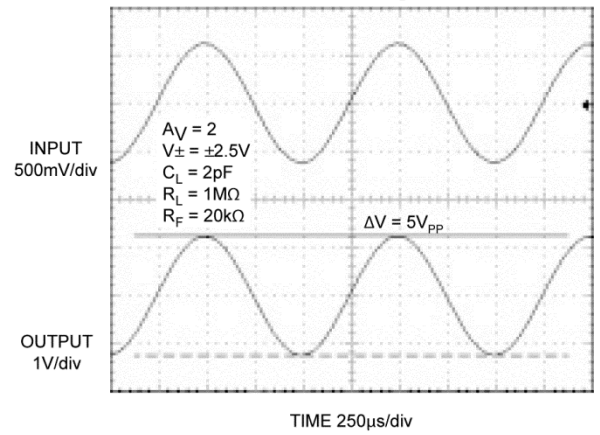

Rail-to-Rail Operation

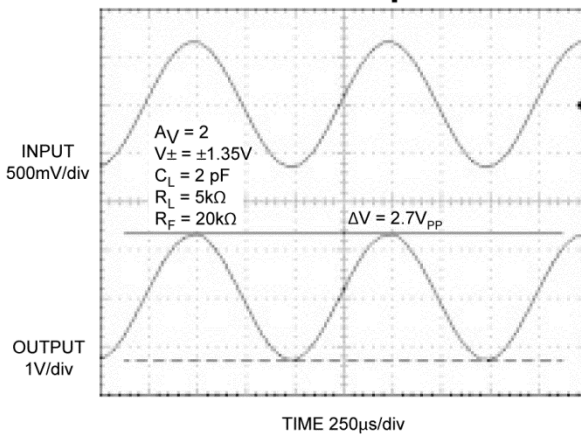

Rail-to-Rail Operation

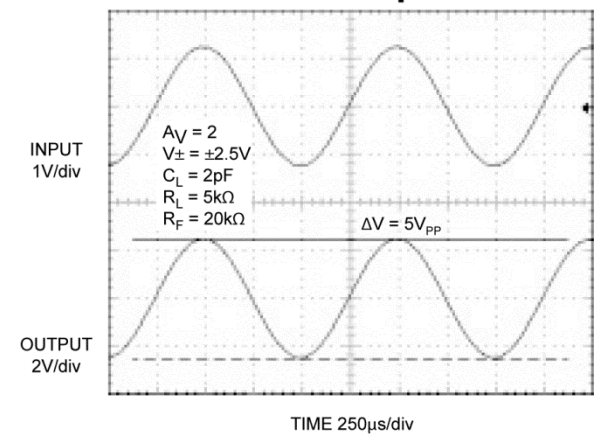

Application Information

Power Supply Bypassing

Regular supply bypassing techniques are recommended. A 10 μ F capacitor in parallel with a 0.1 μ F capacitor on both the positive and negative supplies are ideal. For best performance all bypassing capacitors should be located as close to the op amp as possible and all capacitors should be low ESL (equivalent series inductance), ESR (equivalent series resistance). Surface-mount ceramic capacitors are ideal.

Supply and Loading Resistive Considerations

The MIC862 is intended for single-supply applications configured with a grounded load. It is not advisable to operate the MIC862 under either of the following conditions:

- A grounded load and split supplies ($\pm V$)
- A single supply where the load is terminated above ground.

Under the above conditions, if the load is less than 20k Ω and the output swing is greater than 1V (peak), there may be some instability when the output is sinking current.

Capacitive Load

When driving a large capacitive load, a resistor of 500 Ω is recommended to be connected between the op amp output and the capacitive load to avoid oscillation.

Package Information⁽⁷⁾

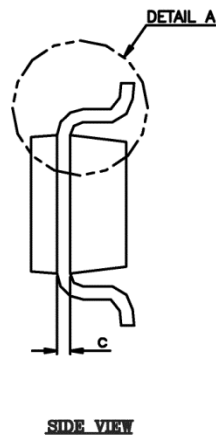
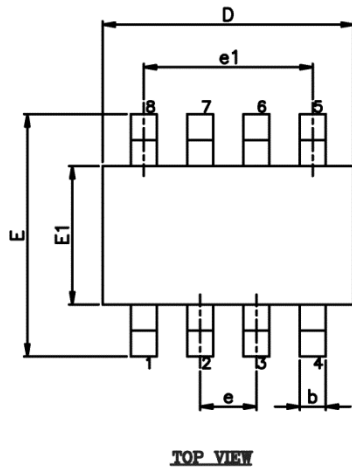

VARIATION(ALL DIMENSIONS SHOWN IN MM)

SYMBOL	MIN.	NOM.	MAX.
A	-	-	1.45
A1	0.00	-	0.15
A2	0.90	1.15	1.30
b	0.22	-	0.38
c	0.08	-	0.22
D	2.90 BSC.		
E	2.80 BSC.		
E1	1.60 BSC.		
e	0.65 BSC.		
e1	1.95 BSC.		
L	0.30	0.45	0.60
L1	0.60 REF.		
L2	0.25 BSC.		
R	0.10	-	-
R1	0.10	-	0.25
θ	0°	4°	8°
θ1	5°	10°	15°

NOTE :
1. JEDEC OUTLINE : MO-178 BA.

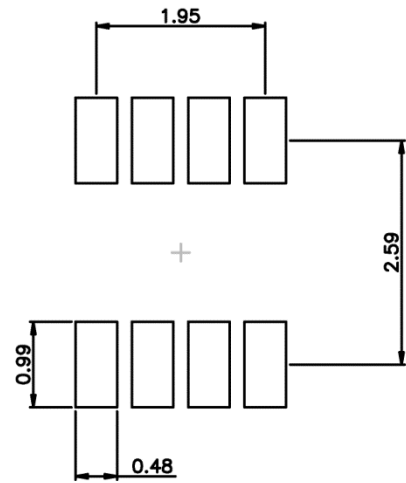
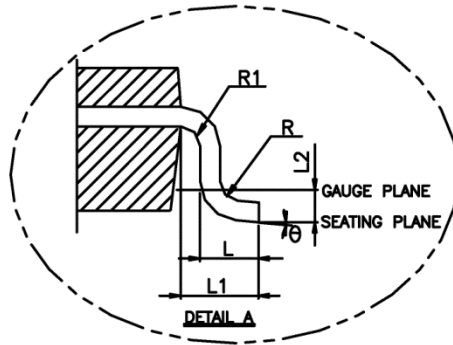
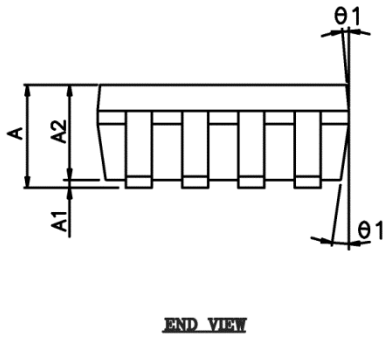

SOT-23-8 (M8)

Note:

7. Package information is correct as of the publication date. For updates and most current information, go to www.micrel.com.

MICREL, INC. 2180 FORTUNE DRIVE SAN JOSE, CA 95131 USA
TEL +1 (408) 944-0800 FAX +1 (408) 474-1000 WEB <http://www.micrel.com>

Micrel makes no representations or warranties with respect to the accuracy or completeness of the information furnished in this data sheet. This information is not intended as a warranty and Micrel does not assume responsibility for its use. Micrel reserves the right to change circuitry, specifications and descriptions at any time without notice. No license, whether express, implied, arising by estoppel or otherwise, to any intellectual property rights is granted by this document. Except as provided in Micrel's terms and conditions of sale for such products, Micrel assumes no liability whatsoever, and Micrel disclaims any express or implied warranty relating to the sale and/or use of Micrel products including liability or warranties relating to fitness for a particular purpose, merchantability, or infringement of any patent, copyright or other intellectual property right.

Micrel Products are not designed or authorized for use as components in life support appliances, devices or systems where malfunction of a product can reasonably be expected to result in personal injury. Life support devices or systems are devices or systems that (a) are intended for surgical implant into the body or (b) support or sustain life, and whose failure to perform can be reasonably expected to result in a significant injury to the user. A Purchaser's use or sale of Micrel Products for use in life support appliances, devices or systems is a Purchaser's own risk and Purchaser agrees to fully indemnify Micrel for any damages resulting from such use or sale.

© 2014 Micrel, Incorporated.