

Audio 1-Chip SOC

BM94803AEKU

General Description

BM94803AEKU is 1-Chip SOC for multimedia audio systems, which supports the USB memory, SD memory card, and CD. This IC has a built-in ARM946ES processor, SDRAM, and various peripherals. It is designated to download programs from external Serial Flash ROM and execute system control, file system management, Audio CODEC, and a wide range of media control.

BM94803AEKU supports USB High-Speed and has built-in DSD Native reproduction function.

Key Features

This IC includes the following blocks:

Processor

- ARM946ES Microprocessor Core

Memory

- SDRAM
- Initial Program ROM
- Program SRAM
- Data SRAM
- SDRAM Controller

System

- Multilayer AHB
- Interrupt Controller
- DMA Controller

Serial, Media I/F

- GPIO
- Pin Controller
- USB2.0 Dual Role(Host/Device) Controller
- SD I/F
- Quad SPI I/F
- SPI I/F (Master/Slave)
- I2C I/F (Master/Slave)
- UART I/F
- I2S Input I/F
- I2S Output I/F
- CD Servo Controllers
- CD-ROM Decoder
- General Purpose A/D Converter

Timer

- Timer
- Watchdog Timer
- Real Time Clock

Other

- Clock Generator
- Reset Generator
- PLL

Package

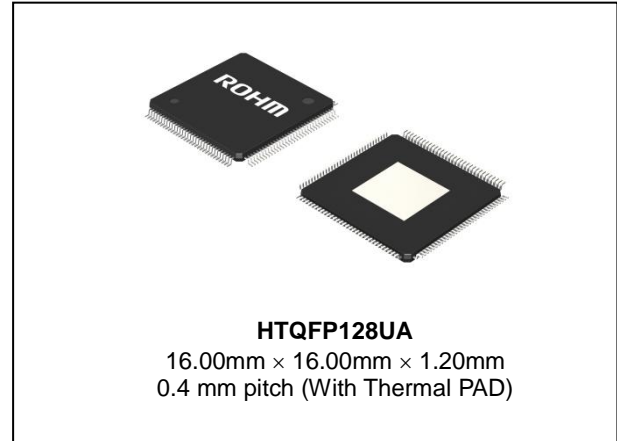

Application

Component Stereo

Application Block

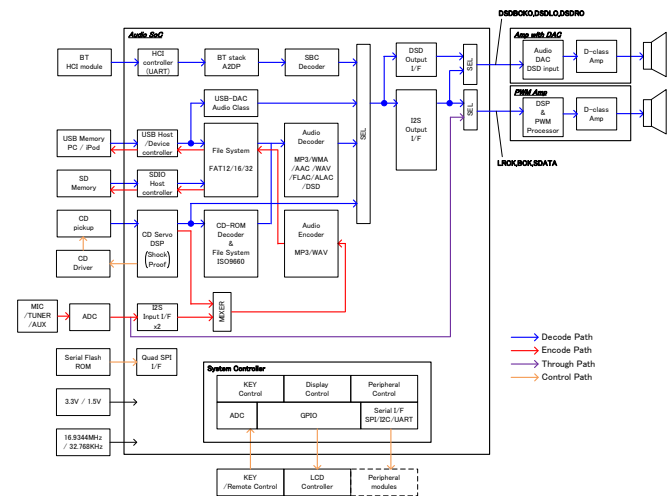

Figure 1. Application Block

Lineup

Type	Package	Orderable Type
BM94803AEKU	HTQFP128UA Tray	BM94803AEKU-Z

Feature

		BM94801KUT	BM94803AEKU
Package		TQFP128UM	HTQFP128UA
Processor	ARM946ES	96MHz	108MHz
	ICache/Dcache	4kB/4kB	4kB/4kB
Memory	SDRAM	16Mbit	16Mbit
	Initial Program ROM	2kByte	2kByte
	Program SRAM	64kByte	64kByte
	Data SRAM	64kByte	64kByte
System	Multilayer AHB	support	support
	Interrupt Controller	support	support
	DMA Controller	2ch	1ch
Peripheral I/F	GPIO	support	support
	Pin Controller	support	support
	USB2.0 Controller	HS 1port	HS 1port
	SD I/F	1ch	1ch
	Quad SPI I/F	1ch	1ch
	SPI I/F (Master)	1ch	1ch
	SPI I/F (Slave)	1ch	1ch
	I2C I/F (Master/Slave)	2ch	2ch
	UART I/F	2ch	2ch
	I2S Input I/F	2ch 2series	2ch 2series
	I2S Output I/F	I2S:stereo + mono 192kHz/24bit	I2S:stereo 192kHz/24bit DSD : 5.6448MHz
	CD Servo Controllers	support	support
	CD-ROM Decoder	support	support
	RemoteControll	support	support
	General purpose A/D Converter	1.5V x 8ch	3.3V x 8ch
Timer	Timer	5ch	5ch
	Watchdog Timer	1ch	1ch
	Real Time Clock	1ch	1ch
Entertainment	DSP	-	-
	PWM out	-	-
Accelerator	FLAC/ALAC	-	-
Clock	Clock Generator	support	support
	Reset Generator	support	support

Note: specification in the Datasheet is correct for the specifications of BM94801KUT.

Feature – continued

ARM946ES Microprocessor Core

- ◇ 32Bit RISC Processor
- ◇ Operating Frequency: 108MHz
- ◇ 8kByte Cache
 - Data Cache 4kByte
 - Instruction Cache 4kByte

SDRAM

- ◇ 16Mbit
- ◇ SDRAM with built-in MSM56V16160N from LAPIS Semiconductor
- ◇ 2Bank x 524,288-word x 16Bit

Initial Program ROM

- ◇ ITCM ROM Size: 2kByte (512Word x 32Bit)
- ◇ boot program
- ◇ No-wait access

REMAP

- ◇ Remapping can be implemented by writing to internal registers.

SHADOW SRAM

- ◇ RAM Size: 512Byte (128-Word x 32-Bit)
- ◇ No-wait access

Program SRAM

- ◇ ITCM RAM Size: 64kByte (16,384-Word x 32-Bit)
- ◇ No-wait access

Data SRAM

- ◇ DTCM RAM Size: 64kByte (16,384-Word x 32-Bit)
- ◇ No-wait access

SDRAM Controller

- ◇ Supports SDRAM
- ◇ Supports 11Bit row address, 8-bit column address, and 1-bit bank address to SDRAM

AMBA

- ◇ 32Bit Data Bus
- ◇ Arbitrates ARM and DMA access with an arbiter

Interrupt Controller

- ◇ 23 IRQ Interrupt Lines
- ◇ 1 FIQ Interrupt Line
- ◇ Allows programmable setting of interrupt priority levels
- ◇ Allows setting of 16 vector addresses

DMA Controller

- ◇ Supports 1 Channel
- ◇ Channel FIFO Depth Up to 16 Bytes
- ◇ Allows programmable setting of transfer data width in the range of 1Byte to 4Bytes
- ◇ Allows programmable setting of channel priority levels
- ◇ Maximum Block Length Up to 4,095 Words
- ◇ Includes 12 handshake interfaces available for assignment to channels with software
- ◇ Supports multiblock transfers
- ◇ Connects the master board to system bus

GPIO

- ◇ GPIO0(32 pins), GPIO1(32 pins), GPIO2(13pins)
- ◇ 4 of 17 pins assigned GPIO2 are not available because of analog pin. (See P9 Pin Description)
- ◇ Supports a maximum of 77 I/O pins (including 13 GPIO pins for exclusive use)
- ◇ Supports the interrupt function
- ◇ Supports external level-sensitive interrupt

Feature – continued

Pin Controller

- ✧ Controls connection settings between pins and blocks

USB2.0 Dual Role (Host/Device) controller

- ✧ USB 2.0 conformance
- ✧ Bit rate: High-Speed (480Mbps)/Full-Speed (12Mbps)
- ✧ Configurable for up to five transmit endpoint FIFOs and four receive endpoint FIFOs (including endpoint 0)
- ✧ Each endpoint FIFO supports bulk transfer, interrupt transfer, and isochronous transfer.
- ✧ 4096-Byte RAM for Endpoint FIFO

SD I/F

- ✧ Supports SDHC, and SD cards
- ✧ Provide access to SD card in SD Bus mode
- ✧ Allows control from the AMBA-AHB Bus
- ✧ Includes 512 Byte data transmit/receive FIFOs

Quad SPI I/F

- ✧ Supports quad serial flash ROM
- ✧ Supports serial flash ROM address up to 24 bits
- ✧ Allows the setting of control registers from the AMBA-AHB bus
- ✧ Allows direct access from the memory map of the AMBA-AHB bus to serial flash ROM
- ✧ Includes 32 byte transmit/receive FIFOs

SSI Master

- ✧ FIFO Depth Up to 16 Words and FIFO Data Width Up to 16Bits
- ✧ Selectable Data Size from 4 Bits to 16 Bits
- ✧ Serial protocol supports SPI from Motorola
- ✧ Includes DMA handshake interface

SSI Slave

- ✧ FIFO Depth Up to 16 Words and FIFO Data Width Up to 16 Bits
- ✧ Selectable Data Size from 4 Bits to 16 Bits
- ✧ Serial protocol supports SPI from Motorola
- ✧ Includes DMA handshake interface

I2C I/F (Master/Slave)

- ✧ 2 Ch I2C Serial Interface
- ✧ Supports two speed modes
- ✧ Standard mode (100Kb/s)
- ✧ Fast mode (400Kb/s)
- ✧ Supports I2C Master and Slave operation
- ✧ Allows 7 and 10 bit address generation
- ✧ Has built-in 32 stage transmit and receive FIFOs
- ✧ Includes DMA handshake interface

UART I/F

- ✧ IS16550-Based
- ✧ Allows various baud rate settings with software (up to 6Mbps)
- ✧ No Support for IrDA
- ✧ FIFO Depth Up to 32 Words and FIFO Data Width Up to 8 Bits
- ✧ Incorporates a function to invert output
- ✧ Includes DMA handshake interface

Feature – continued

I2S Input I/F

- ◇ Two Lines of 2-Ch Digital Audio Input
- ◇ I2S, EIAJ format
- ◇ 16-Bit Data
- ◇ Selectable Bit Clock from 32fs, 48fs, and 64fs
- ◇ Selectable Input Sample Rate from 32kHz, 44.1kHz, and 48kHz
- ◇ One Line of Internal Input from the CD Servo Controller
- ◇ Maximum Input Rate Up to 4x
- ◇ Supports detection of CD-DA link
- ◇ Supports detection of CD-ROM sync
- ◇ Supports CD-ROM data descrambling
- ◇ Acquires Sub-Q data
- ◇ Acquires CD-Text data
- ◇ Built-in DMA 2ch
- ◇ Supports I2S Input at CD Play

I2S Output I/F

- ◇ 2-Ch Digital Audio Output x 1 (2ch from Decoder)
- ◇ I2S, EIAJ format
- ◇ Selectable PCM Output Sample Rate from 32k, 44.1k, 48k, 88.2k, 96k, 176.4k, 192kHz
- ◇ Selectable PCM Data Width from 16 and 24 bits
- ◇ 64 fs PCM Bit Clock
- ◇ Supports pitch control (x0.5 - x2.0, 25step)
- ◇ Selectable DSD Output Sample Rate from DSD 2.8224MHz, 5.6448MHz

CD servo controller

- ◇ Supports rotation speed of CD up to 4x
- ◇ Built-in Preservo-Amplifier with Power Save Mode, which supports Playback of CD-RW
- ◇ Allows independent offset adjustment of AC, BD, E, and F amplifiers
- ◇ Built-in Auto-Tracking and Focus Adjustment Function
- ◇ Built-in PLL and CLV with a Wide Lock Range
- ◇ Built-in Asymmetry Correction Function

CD-ROM Decoder

- ◇ Supports Mode1, Mode2 form1, Mode2 form2
- ◇ Supports ECC, EDC
- ◇ Built-in DMA

General Purpose A/D Converter

- ◇ 10-Bit SAR ADC, 8 Ch ADC
- ◇ Analog Input Voltage range: VDD_ADC x10% to VDD_ADC x 90%
- ◇ Maximum A/D Conversion frequency Ch=88.2ksps

Timer

- ◇ Supports five independent programmable timer functions
- ◇ Each timer supports time width up to 32 bits
- ◇ Each timer supports independent interrupt signal

Watchdog Timer

- ◇ Composed of a counter having a set cycle to monitor the occurrence of timeout event
- ◇ Counter Width Up to 32 Bits
- ◇ The counter counts down from the set value and sets timeout occurrence when it reaches zero

Realtime clock

- ◇ 32 Bit Programmable Timer
- ◇ Supports interrupt signals
- ◇ External 32.768 kHz Crystal Oscillator

Feature – continued

Remote Controller Receiver (RCR)

- ◇ Converts infrared remote control signal to code
- ◇ Compatible with the signal format of the Association for Electric Home Appliances
- ◇ Supports Sony format
- ◇ Enables to setup permissible value of input signal cycle to adjust the Duty deviation of input signal

Clock Generator

- ◇ Supplies clocks to individual internal blocks
- ◇ Allows on/off control of clocks to individual blocks
- ◇ Generates master audio clocks
- ◇ At the normal operation, supports three modes (High-Speed mode, Middle Speed mode, Low-Speed mode)
- ◇ Supports Standby Mode

Reset Generator

- ◇ Generates a pulse to be supplied to individual blocks

PLL

- ◇ Generates 216MHz / 240MHz clock used to generate system clocks
- ◇ Generates 135.4752 MHz and 147.456 MHz clocks used to generate audio clocks

Power Supply Voltage

- ◇ I/O Power Supply Voltage : 3.3V(3.0V to 3.6V)
- ◇ Analog Power Supply Voltage: 3.3V(3.0V to 3.6V)
(Used for SDRAM, CD servo, USB, and ADC)
- ◇ Digital Core Power Supply Voltage : 1.5V(1.45V to 1.65V)
(Used for Digital Core)

Pin Assignment

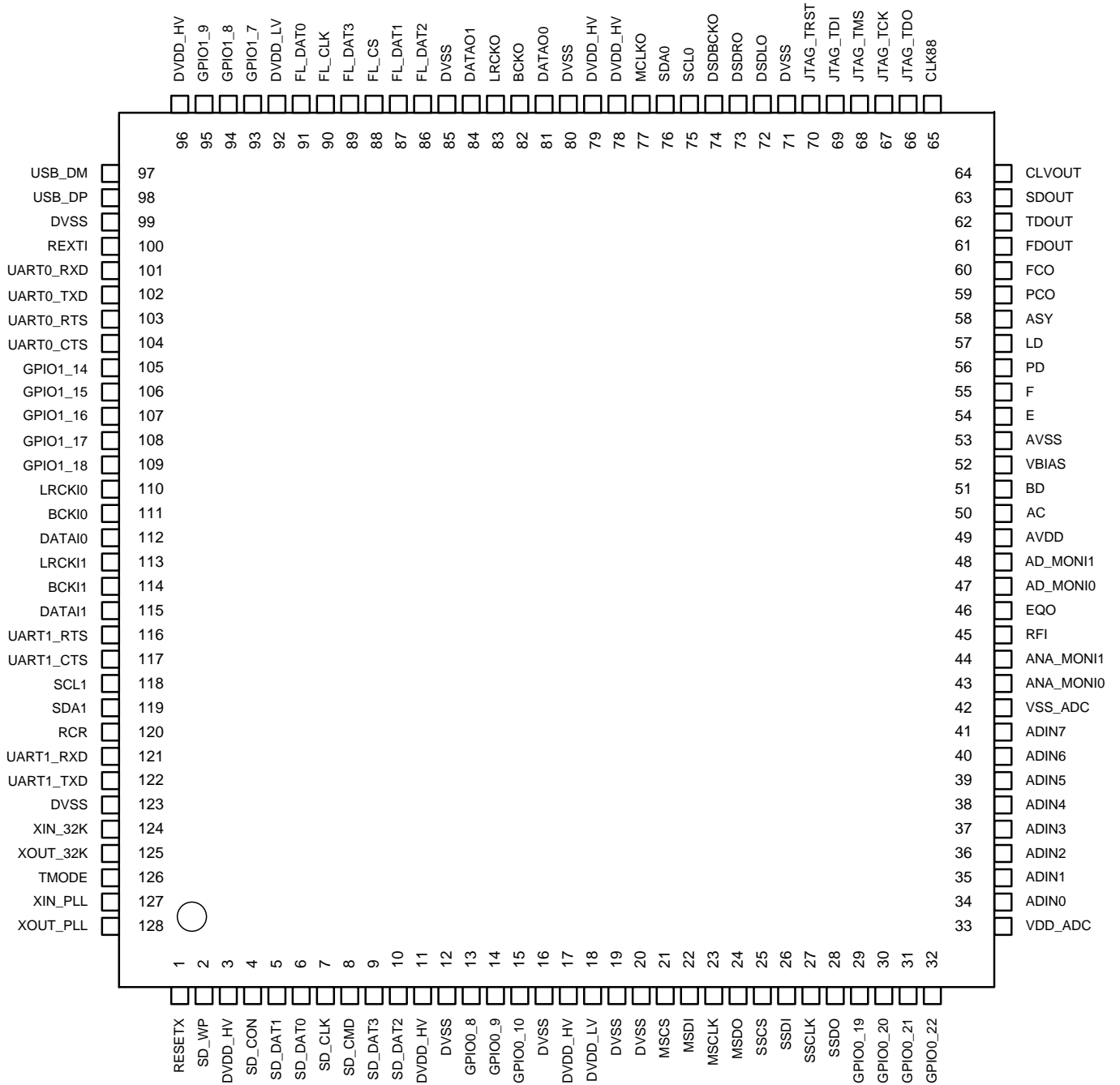

Figure 2. Pin Assignment

Pin Description

No	Block	Pin Name	GPIO	I/O	Function
1	RESET	RESETX		I	H: Release RESET, L: RESET
2	SD	SD_WP	GPIO0[0]	I/O	SD Card I/F WP Detect
3	POWER	DVDD_HV		-	3.3V Power Supply
4	SD	SD_CON	GPIO0[1]	I/O	SD Card I/F Connection Detect
5	SD	SD_DAT1	GPIO0[2]	I/O	SD Card I/F Data I/O (1)
6	SD	SD_DAT0	GPIO0[3]	I/O	SD Card I/F Data I/O (0)
7	SD	SD_CLK	GPIO0[4]	I/O	SD Card I/F Clock Output
8	SD	SD_CMD	GPIO0[5]	I/O	SD Card I/F Command Output
9	SD	SD_DAT3	GPIO0[6]	I/O	SD Card I/F Data I/O (3)
10	SD	SD_DAT2	GPIO0[7]	I/O	SD Card I/F Data I/O (2)
11	POWER	DVDD_HV		-	3.3V Power Supply
12	POWER	DVSS		-	GND
13	GPIO	GPIO0_8	GPIO0[8]	I/O	GPIO for exclusive use
14	GPIO	GPIO0_9	GPIO0[9]	I/O	GPIO pin. When CD is used, this pin is TRAY OPEN/CLOSE detect pin of CD mechanical tray.
15	GPIO	GPIO0_10	GPIO0[10]	I/O	GPIO for exclusive use
16	POWER	DVSS		-	GND
17	POWER	DVDD_HV		-	3.3V Power Supply
18	POWER	DVDD_LV		-	1.5V Power Supply
19	POWER	DVSS		-	GND
20	POWER	DVSS		-	GND
21	MSIO	MSCS	GPIO0[11]	I/O	SIO Master Chip Select Output
22	MSIO	MSDI	GPIO0[12]	I/O	SIO Master Data Input
23	MSIO	MSCLK	GPIO0[13]	I/O	SIO Master Clock Output
24	MSIO	MSDO	GPIO0[14]	I/O	SIO Master Data Output
25	SSIO	SSCS	GPIO0[15]	I/O	SIO Slave Chip Select Input
26	SSIO	SSDI	GPIO0[16]	I/O	SIO Slave Data Input
27	SSIO	SSCLK	GPIO0[17]	I/O	SIO Slave Clock Input
28	SSIO	SSDO	GPIO0[18]	I/O	SIO Slave Data Output
29	GPIO	GPIO0_19	GPIO0[19]	I/O	GPIO for exclusive use
30	GPIO	GPIO0_20	GPIO0[20]	I/O	GPIO for exclusive use
31	GPIO	GPIO0_21	GPIO0[21]	I/O	GPIO pin. When CD is used, this pin is INNER_SW detect pin.
32	GPIO	GPIO0_22	GPIO0[22]	I/O	GPIO for exclusive use
33	POWER	VDD_ADC		-	3.3V ADC Power Supply
34	ADC	ADIN0	GPIO2[0]	I	AD input CH0 or GPIO
35	ADC	ADIN1	GPIO2[1]	I	AD input CH1 or GPIO
36	ADC	ADIN2	GPIO2[2]	I	AD input CH2 or GPIO
37	ADC	ADIN3	GPIO2[3]	I	AD input CH3 or GPIO
38	ADC	ADIN4	GPIO2[4]	I	AD input CH4 or GPIO
39	ADC	ADIN5	GPIO2[5]	I	AD input CH5 or GPIO
40	ADC	ADIN6	GPIO2[6]	I	AD input CH6 or GPIO
41	ADC	ADIN7	GPIO2[7]	I	AD input CH7 or GPIO
42	POWER	VSS_ADC		-	ADC GND
43	CDDSP	ANA_MONI0	GPIO2[8]	I/O	Input & Analog Monitor Output or GPIO
44	CDDSP	ANA_MONI1	GPIO2[9]	I/O	Input & Analog Monitor Output or GPIO
45	CDDSP	RFI		I	RF Output Capacitance Coupling Re-Input
46	CDDSP	EQO		O	Output RF Equalizer
47	CDDSP	AD_MONI0	GPIO2[10]	I/O	Input & Monitor Signal Output or GPIO
48	CDDSP	AD_MONI1	GPIO2[11]	I/O	Input & Monitor Signal Output or GPIO
49	POWER	AVDD		-	3.3V CD RF Power Supply
50	CDDSP	AC		I	A + C Voltage Input
51	CDDSP	BD		I	B + D Voltage Input
52	CDDSP	VBIAS		O	VBIAS Output
53	POWER	AVSS		-	CD RF GND
54	CDDSP	E		I	E Voltage Input
55	CDDSP	F		I	F Voltage Input
56	CDDSP	PD		I	APC Photo Detector Input
57	CDDSP	LD		O	APC Laser Drive Output

Pin Description – continued

No	Block	Pin Name	GPIO	I/O	Function
58	CDDSP	ASY		I	Asymmetric Correction
59	CDDSP	PCO		O	PLL PCO Output
60	CDDSP	FCO		O	PLL FCO-DAC Output
61	CDDSP	FDOOUT	GPIO2[12]	I/O	Focus Drive Output Use this pin as analog pin.
62	CDDSP	TDOUT	GPIO2[13]	I/O	Tracking Drive Output Use this pin as analog pin.
63	CDDSP	SDOUT	GPIO2[14]	I/O	Sled Drive Output Use this pin as analog pin.
64	CDDSP	CLVOUT	GPIO2[15]	I/O	CLV Drive Output Use this pin as analog pin.
65	CDDSP	CLK88	GPIO2[16]	I/O	Clock Output for Driver IC or GPIO
66	JTAG	JTAG_TDO		O	JTAG TDO
67	JTAG	JTAG_TCK		I	JTAG TCK
68	JTAG	JTAG_TMS		I	JTAG TMS
69	JTAG	JTAG_TDI		I	JTAG TDI
70	JTAG	JTAG_TRST		I/O	JTAG TRST
71	POWER	DVSS		-	GND
72	DSD/GPIO	DSDLO	GPIO0[23]	I/O	DSD Lch Data Output or GPIO
73	DSD/GPIO	DSDRO	GPIO0[24]	I/O	DSD Rch Data Output or GPIO
74	DSD/GPIO	DSDBCKO	GPIO0[25]	I/O	DSD Bit Clock Output or GPIO
75	I2C	SCL0	GPIO0[26]	I/O	I2C Clock I/O (0), Open drain output pin
76	I2C	SDA0	GPIO0[27]	I/O	I2C Data I/O (0), Open drain output pin
77	I2S OUT	MCLKO	GPIO0[28]	I/O	Digital Audio Master Clock Output
78	POWER	DVDD_HV		-	3.3V Power Supply
79	POWER	DVDD_HV		-	3.3V Power Supply
80	POWER	DVSS		-	GND
81	I2S OUT	DATAO0	GPIO0[29]	I/O	Digital Audio Data Output (0)
82	I2S OUT	BCKO	GPIO0[30]	I/O	Digital Audio Bit Clock Output
83	I2S OUT	LRCKO	GPIO0[31]	I/O	Digital Audio Channel Clock Output
84	I2S OUT	DATAO1	GPIO1[0]	I/O	Digital Audio Data Output (1)
85	POWER	DVSS		-	GND
86	FLASH	FL_DAT2	GPIO1[1]	I/O	Serial Flash ROM I/F Data I/O (2)
87	FLASH	FL_DAT1	GPIO1[2]	I/O	Serial Flash ROM I/F Data I/O (1)
88	FLASH	FL_CS	GPIO1[3]	I/O	Serial Flash ROM I/F Command Output
89	FLASH	FL_DAT3	GPIO1[4]	I/O	Serial Flash ROM I/F Data I/O (3)
90	FLASH	FL_CLK	GPIO1[5]	I/O	Serial Flash ROM I/F Clock Output
91	FLASH	FL_DAT0	GPIO1[6]	I/O	Serial Flash ROM I/F Data I/O (0)
92	POWER	DVDD_LV		-	1.5V Power Supply
93	GPIO	GPIO1_7	GPIO1[7]	I/O	GPIO for exclusive use
94	GPIO	GPIO1_8	GPIO1[8]	I/O	GPIO for exclusive use
95	GPIO	GPIO1_9	GPIO1[9]	I/O	GPIO for exclusive use
96	POWER	DVDD_HV		-	3.3V Power Supply
97	USB	USB_DM		I/O	USB D-
98	USB	USB_DP		I/O	USB D+
99	POWER	DVSS		-	GND
100	USB	REXTI		I	USB Reference Voltage Output. Connect a pull down resistance to DVSS pin. The pull down resistance must be 12.3 kΩ±1%. About on PCB, do not wire as long as possible and not wire side by side long distance with noise line, especially note the next pin UART0_RXD(pin101).

Pin Description - continued

No	Block	Pin Name	GPIO	I/O	Function
101	UART	UART0_RXD	GPIO1[10]	I/O	UART0 Receive Data
102	UART	UART0_TXD	GPIO1[11]	I/O	UART0 Transmit Data
103	UART	UART0_RTS	GPIO1[12]	I/O	UART0 Transfer Request
104	UART	UART0_CTS	GPIO1[13]	I/O	UART0 Clear Request
105	GPIO	GPIO1_14	GPIO1[14]	I/O	GPIO for exclusive use
106	GPIO	GPIO1_15	GPIO1[15]	I/O	GPIO for exclusive use
107	GPIO	GPIO1_16	GPIO1[16]	I/O	GPIO for exclusive use
108	GPIO	GPIO1_17	GPIO1[17]	I/O	GPIO for exclusive use
109	GPIO	GPIO1_18	GPIO1[18]	I/O	GPIO for exclusive use
110	I2S IN	LRCKI0	GPIO1[19]	I/O	Digital Audio Channel Clock Input (0)
111	I2S IN	BCKI0	GPIO1[20]	I/O	Digital Audio Bit Clock Input (0)
112	I2S IN	DATAI0	GPIO1[21]	I/O	Digital Audio Data Input (0)
113	I2S IN	LRCKI1	GPIO1[22]	I/O	Digital Audio Channel Clock Input (1)
114	I2S IN	BCKI1	GPIO1[23]	I/O	Digital Audio Bit Clock Input (1)
115	I2S IN	DATAI1	GPIO1[24]	I/O	Digital Audio Data Input (1)
116	UART	UART1_RTS	GPIO1[25]	I/O	UART1 Transfer Request
117	UART	UART1_CTS	GPIO1[26]	I/O	UART1 Clear Request
118	I2C	SCL1	GPIO1[27]	I/O	I2C Clock I/O (1), Open drain output pin
119	I2C	SDA1	GPIO1[28]	I/O	I2C Data I/O (1), Open drain output pin
120	RCR	RCR	GPIO1[29]	I/O	Remote Controller Signal Input
121	UART	UART1_RXD	GPIO1[30]	I/O	UART1 Receive Data
122	UART	UART1_TXD	GPIO1[31]	I/O	UART1 Transmit Data
123	POWER	DVSS		-	GND
124	CLOCK	XIN_32K		I	X'tal(32.768KHz) connection input pin.
125	CLOCK	XOUT_32K		O	X'tal(32.768KHz) connection output pin.
126	TEST	TMODE		I	Test Mode pin: This pin is connected to GND.
127	CLOCK	XIN_PLL		I	X'tal(16.9344MHz) Connection Input
128	CLOCK	XOUT_PLL		O	X'tal(16.9344MHz) Connection Output

Application Circuit Diagram

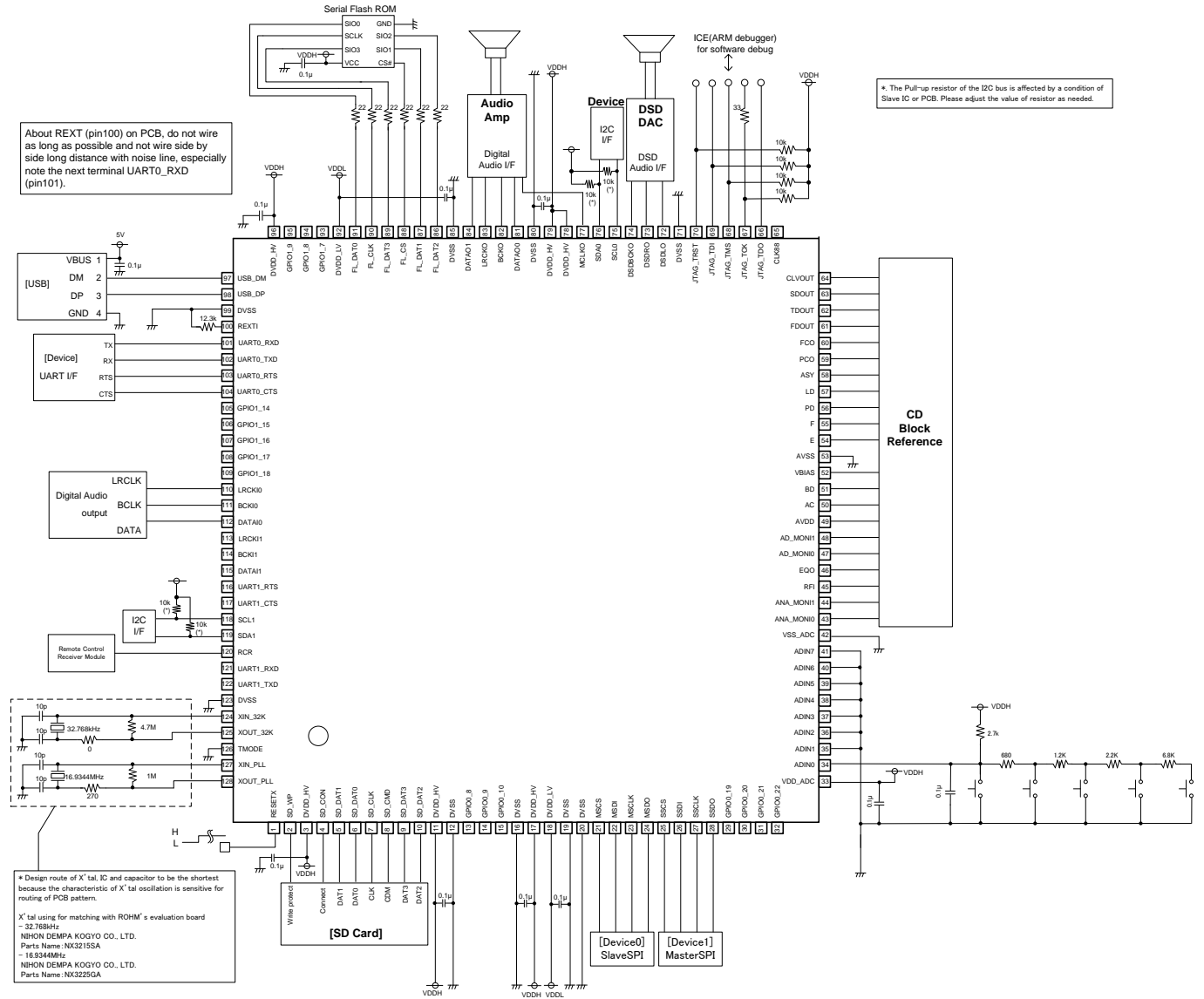

Figure 3. Application Circuit Diagram

Absolute Maximum Ratings (Ta=25°C)

Parameter	Symbol	Rating	Unit	Remarks
Input Voltage (Analog, I/O)	VDDHMAX	-0.3 to +4.5	V	DVDD_HV, VDD_ADC, AVDD
Input Voltage (Core)	VDDLMAX	-0.3 to +2.1	V	DVDD_LV
Input Voltage	VIN	-0.3 to VDDH+0.3	V	
Storage Temperature Range	TSTG	-55 to +125	°C	
Operating Temperature Range	TOPR	-40 to +85	°C	
Maximum Junction Temperature	Tjmax	+125	°C	

Caution: Operating the IC over the absolute maximum ratings may damage the IC. The damage can either be a short circuit between pins or an open circuit between pins and the internal circuitry. Therefore, it is important to consider circuit protection measures, such as adding a fuse, in case the IC is operated over the absolute maximum ratings.

Recommended Operating Conditions (Ta=25°C)

Parameter	Symbol	Rating	Unit	Remarks
Input Voltage (Analog, I/O)	VDDH	3.0 to 3.6	V	DVDD_HV, VDD_ADC, AVDD
Input Voltage (Core)	VDDL	1.45 to 1.65	V	DVDD_LV

Thermal Resistance (Note 1)

Parameter	Symbol	Thermal Resistance (Typ)		Unit
		1s (Note 3)	2s2p (Note 4)	
HTQFP128UA				
Junction to Ambient	θ_{JA}	54.9	27.6	°C/W
Junction to Top Characterization Parameter (Note 2)	Ψ_{JT}	10	9	°C/W

(Note 1) Based on JE51-2A(Still-Air)

(Note 2) The thermal characterization parameter to report the difference between junction temperature and the temperature at the top center of the outside surface of the component package.

(Note 3) Using a PCB board based on JE51-3.

(Note 4) Using a PCB board based on JE51-5, 7.

Layer Number of Measurement Board	Material	Board Size
Single	FR-4	114.3mm x 76.2mm x 1.57mmt

Top	
Copper Pattern	Thickness
Footprints and Traces	70µm

Layer Number of Measurement Board	Material	Board Size	Thermal Via (Note 5)	
			Pitch	Diameter
4 Layers	FR-4	114.3mm x 76.2mm x 1.6mmt	1.20mm	Φ0.30mm

Top		2 Internal Layers		Bottom	
Copper Pattern	Thickness	Copper Pattern	Thickness	Copper Pattern	Thickness
Footprints and Traces	70µm	74.2mm (Square)	35µm	74.2mm (Square)	70µm

(Note 5) This thermal via connects with the copper pattern of all layers.

Caution: As reference information of thermal design, thermal resistance of 1s and 2s2p are described. If the maximum junction temperature rating be exceeded the rise in temperature of the chip may result in deterioration of the properties of the chip. Increase the board size and copper area to prevent exceeding the maximum junction temperature rating. This IC is recommended more than 2s PCB.

Electrical Characteristics

(Unless otherwise noted, Ta=25°C, DVDD_HV = VDD_ADC = AVDD = 3.0V, DVDD_LV = 1.5V, DVSS=VSS_ADC=AVSS =0V, XIN_PLL= 16.9344MHz, XIN_32K =32.768kHz, REXTI pin externally fitted resistance = 12.3 kΩ±1%)

Parameter	Symbol	Rating			Unit	Conditions Suitable Pin
		MIN	TYP	MAX		
<Overall>						
Operating Current Consumption (VDDH)	IDDS1	-	115	180	mA	Using USB High-Speed
Operating Current Consumption (VDDL)	IDD2	-	150	210	mA	
In a standby mode Consumption current (VDDH)	ISTBH	-	1.1	-	mA	At standby mode
In a standby mode Consumption current (VDDL)	ISTBL	-	50	-	μA	At standby mode
<Logic Interface>						
H input current	IIH	-	-	1.0	μA	(Note 1)
L input current	IIL	-1.0	-	-	μA	(Note 1)
Input "H" Voltage	VIH	VDDH*0.7	-	VDDH	V	(Note 1)
Input "L" Voltage	VIL	DVSS	-	VDDH*0.3	V	(Note 1)
Output "H" Voltage 1	VOH1	VDDH-0.4	-	VDDH	V	IOH=-1.6mA, (Note 2)
Output "L" Voltage 1	VOL1	0	-	0.4	V	IOL=1.6mA, (Note 2)
Output "H" Voltage 2	VOH2	VDDH-0.4	-	VDDH	V	IOH=-3.6mA, (Note 3)
Output "L" Voltage 2	VOL2	0	-	0.4	V	IOL=3.6mA, (Note 3) (Note 4)
Output "H" Voltage 3	VOH3	VDDH-1.0	-	VDDH	V	IOH=-0.6mA, (Note 5)
Output "L" Voltage 3	VOL3	0	-	1.0	V	IOL=0.6mA, (Note 5)
<USB Interface>						
Idle Pull-Up Resistance	RPU_ID	0.9	-	1.575	kΩ	(Note 7)
RX Pull-Up Resistance	RPU_RX	1.425	-	3.09	kΩ	(Note 7)
Pull-Down Resistance	RPD	14.25	-	24.8	kΩ	(Note 6)
HS High Voltage	VHSOH	360	-	440	mV	(Note 6)
HS RX Differential Input Sensitivity	VHSSQ	100	-	-	mV	(Note 6)
HS RX Differential Input Range	VHSCM	-50	-	600	mV	(Note 6)
HS Disconnect Judgment Voltage	VHSDSC	525	-	625	mV	(Note 6)
Chirp J Voltage	VCHIRPJ	700	-	1100	mV	Measured at 45Ω Output Termination (Note 6)
Chirp K Voltage	VCHIRPK	-900	-	-500	mV	(Note 6)
FS High Output Impedance	ZFDRH	-	45	-	Ω	(Note 6)
FS Low Output Impedance	ZFDRL	-	45	-	Ω	(Note 6)
FS High Voltage	VFOH	2.8	-	3.6	V	Measured when pin is pulled down to VSS using 15 kΩ resistor (Note 6)
FS Low Voltage	VFOL	0	-	0.3	V	Measured when pin is pulled up to DVDD_HV using 1.5 kΩ resistor (Note 6)
FS RX Differential Input Sensitivity	VFLSNS	-	-	200	mV	(Note 6)
FS RX Differential Input Range	VFLCM	0.8	-	2.5	V	(Note 6)
H input voltage	VIHUSB	2	-	VDDH	V	(Note 6)
L input voltage	VILUSB	DVSS	-	0.8	V	(Note 6)
<ADC>						
A/D Conversion Frequency	FADCONV	-	-	705.6	kHz	FADCONV≤16.9344MHz/24
Analog Input Voltage Range	VAIN	0.1*VDDH	-	0.9*VDDH	V	
Differential Non-Linearity	DNL	-	-	±5	LSB	
Integral Non-Linearity	INL	-	-	±5	LSB	

(Note 1) Input pin 1,2,4-10,13-15,21-32,34-41,43-44,47-48,65,67-70,72-77,81-84,86-91,93-95,101-122 pin
 (Note 2) Output pin1 13-15,29-32,34-41,43,44,47,48,61-66,77,81-84,93-95,101-117,120-122 pin
 (Note 3) Output pin2 2,4-10,21-28,72-74,86-91 pin
 (Note 4) Output pin3 75,76,118,119 pin
 (Note 5) Output pin4 125,128 pin
 (Note 6) USB pin 97,98 pin
 (Note 7) USB pin 98 pin

Electrical Characteristics – continued

(Unless otherwise noted, Ta=25°C, DVDD_HV = VDD_ADC = AVDD = 3.0V, DVDD_LV = 1.55V, DVSS= VSS_ADC= AVSS= 0V, XIN_PLL= 16.9344MHz, XIN_32K =32.768kHz, RL=10kΩ, VBIAS=Reference)

Parameter	Symbol	Rating			Unit	Conditions Suitable Pin
		MIN	TYP	MAX		
<PLL (VCO) Block>						
Maximum Oscillation Frequency	fVCOH	4.6	6.5	-	MHz	GPIO1_7,1/4 of VCO Output
Minimum Oscillation Frequency	fVCOL	-	1.1	1.7	MHz	GPIO1_7,1/4 of VCO Output
<FC DAC>						
Offset Voltage	VFCOF	-50	-	+50	mV	FCO
Maximum Output Voltage	VFCH	0.2	0.5	-	V	FCO
Minimum Output Voltage	VFCL	-	-0.5	-0.2	V	FCO
<PCO.>						
Output "L" Voltage	VPCH	-	-1.0	-0.6	V	PCO
Output "H" Voltage	VPCL	0.6	1.0	-	V	PCO
< EFM Comparator >						
Threshold Voltage	VEFM	-200	-	200	mV	RFI,ANA_MONIO,GPIO1_8
<Servo ADC>						
Offset Voltage	VADOF	-140	-	+140	mV	ANA_MONIO,ANA_MONI1
Maximum Conversion Voltage	VADH	1.0	1.2	1.4	V	ANA_MONIO,ANA_MONI1
Minimum Conversion Voltage	VADL	-1.4	-1.2	-1.0	V	ANA_MONIO,ANA_MONI1
<Servo DAC>						
Offset Voltage	VDAOF	-80	-	+80	mV	FDOUT,TDOUT,SDOUT,CLVOUT
Maximum Output Voltage	VDAH	0.8	1.2	-	V	FDOUT,TDOUT,SDOUT,CLVOUT
Minimum Output Voltage	VDAL	-	-1.2	-0.8	V	FDOUT,TDOUT,SDOUT,CLVOUT
<Bias Amplifier>						
Maximum Output Current	IBO	-	±1.5	-	mA	VBIAS, BIAS Fluctuation: 200mV or less
<RF Amplifier>						
Offset Voltage	VRFOF	-	0	-	mV	AC,BD,EQO
Maximum Output Voltage	VRFH	1.0	1.2	-	V	AC,BD,EQO
Minimum Output Voltage	VRFL	-	-1.3	-1.1	V	AC,BD,EQO
<FE Amplifier>						
Offset Voltage	VFEOF	-	0	-	mV	AC,BD,ANA_MONIO,ANA_MONI1
Maximum Output Voltage	VFEH	1.0	1.4	-	V	AC,BD,ANA_MONIO,ANA_MONI1
Minimum Output Voltage	VFEL	-	-1.4	-1.0	V	AC,BD,ANA_MONIO,ANA_MONI1
<TE Amplifier>						
Offset Voltage	VTEOF	-	70	-	mV	E,F,ANA_MONIO,ANA_MONI1
Maximum Output Voltage	VTEH	1.0	1.4	-	V	E,F,ANA_MONIO,ANA_MONI1
Minimum Output Voltage	VTEL	-	-1.4	-1.0	V	E,F,ANA_MONIO,ANA_MONI1
<Asymmetry Amplifier>						
Offset Voltage	VASYOF	-	0	-	mV	ASY=VBIAS,RFI,ANA_MONIO
Maximum Output Voltage	VASYH	1.1	1.4	-	V	ASY,RFI,ANA_MONIO
Minimum Output Voltage	VASYL	-	-1.4	-1.1	V	ASY,RFI,ANA_MONIO
<APC Block>						
Output Voltage 1	VAPC1	2.4	2.8	-	V	PD="H", LD,ANA_MONIO
Output Voltage 2	VAPC2	-	0.1	0.5	V	PD="L", LD,ANA_MONIO
Maximum Reference Voltage	VAPCH	-	220	-	mV	PD,LD,ANA_MONIO
Minimum Reference	VAPCL	-	145	-	mV	PD,LD,ANA_MONIO

Application Information

Power on/ Reset Timing/ Power off

Release the Reset Signal by L input with over 100µs after clock input from I/O pins of 16.9344MHz becomes stable.
(See Figure 4)

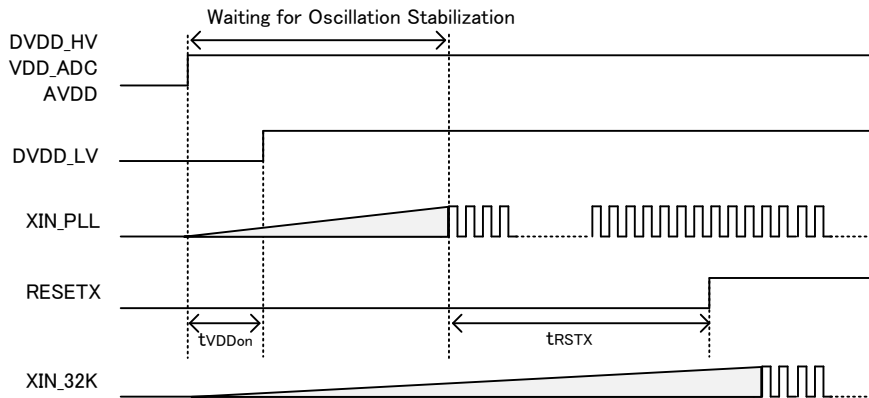

Figure 4. Power on/ Reset Timing

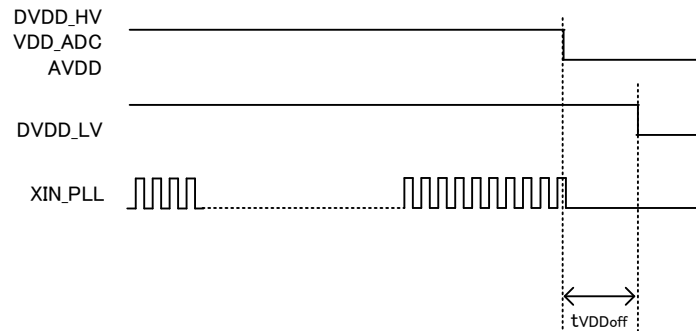

Figure 5. Power off

Parameter	Symbol	Rating			Unit	Remarks
		MIN	TYP	MAX		
Time lag of Power Supply at Starting	tVDDon	0	-	-	ms	
Reset L Interval	tRSTX	100	-	-	µs	
Time lag of Power Supply at Shutting down.	tVDDoff	0	-	-	ms	

Note) There is a risk that the electric current flows in case the order of power supply starting and shutting down is other than the above order.

Oscillation Stable Time

Suggested value for XIN_PLL(16.9344MHz) oscillation stable time is 4ms.

Suggested value for XIN_32K(32.768kHz) oscillation stable time is 500ms.

The above-mentioned oscillation stable time cannot be guaranteed since the oscillation stable time depends on crystal oscillator, external constant, or board layout. Check the oscillation stable time of your own system.

I/O Equivalence Circuits

No.	Name	I/O	Power	Internal Circuits	No.	Name	I/O	Power	Internal Circuits						
1	RESETX	I	DVDD_HV		2	SD_WP	I	DVDD_HV							
34	ADIN0	I	VDD_ADC		4	SD_CON	I	DVDD_HV							
35	ADIN1	I			5	SD_DAT1	I/O								
36	ADIN2	I			6	SD_DAT0	I/O								
37	ADIN3	I			7	SD_CLK	O								
38	ADIN4	I			8	SD_CMD	O								
39	ADIN5	I			9	SD_DAT3	I/O								
40	ADIN6	I			10	SD_DAT2	I/O								
41	ADIN7	I	13	GPIO0_8	I/O										
43	ANA_MONI0	O	AVDD		14	GPIO0_9	I/O			DVDD_HV					
44	ANA_MONI1	O			15	GPIO0_10	I/O								
47	AD_MONI0	O			21	MSCS	O								
48	AD_MONI1	O			22	MSDI	I								
61	FDOUT	O			23	MSCLK	O								
62	TDOUT	O			24	MSDO	O								
63	SDOUT	O			25	SSCS	I								
64	CLVOUT	O	26	SSDI	I										
45	RFI	I	AVDD		27	SSCLK	I	DVDD_HV							
46	EQO	O			28	SSDO	O								
50	AC	I			AVDD		29		GPIO0_19		I/O	DVDD_HV			
51	BD	I					30		GPIO0_20		I/O				
54	E	I					AVDD			31	GPIO0_21		I/O	DVDD_HV	
55	F	I								32	GPIO0_22		I/O		
										65	CLK88		O		DVDD_HV
										72	DSDLO		I/O		
										73	DSDRO		I/O		
										74	DSDBCKO		I/O		
										77	MCLKO		O		
										81	DATA00		O		
			82	BCKO				O							
			83	LRCKO				O							
			84	DATA01	O										
			93	GPIO1_7	I/O	DVDD_HV									
			94	GPIO1_8	I/O										
			95	GPIO1_9	I/O										
			101	UART0_RXD	I										
			102	UART0_TXD	O										
			103	UART0_RTS	O										
			104	UART0_CTS	I										
			105	GPIO1_14	I/O										
			106	GPIO1_15	I/O										
			107	GPIO1_16	I/O										
			108	GPIO1_17	I/O										
			109	GPIO1_18	I/O										
			110	LRCKI0	I										
			111	BCKI0	I										
			112	DATAI0	I										
			113	LRCKI1	I										
			114	BCKI1	I										
			115	DATAI1	I										
			116	UART1_RTS	I/O										
			117	UART1_CTS	I/O										
			120	RCR	I										
			121	UART1_RXD	I										
			122	UART1_TXD	O										

Figure 6. I/O equivalence circuits 1

I/O Equivalence Circuits – continued

No.	Name	I/O	Power	Internal Circuits	No.	Name	I/O	Power	Internal Circuits
56	PD	I	AVDD		75	SCL0	I/O	DVDD_HV	
57	LD	O			76	SDA0	I/O		
58	ASY	I	AVDD		118	SCL1	I/O		
					119	SDA1	I/O		
					86	FL_DAT2	I/O		
					87	FL_DAT1	I/O		
					88	FL_CS	O		
52	VBIAS	O	AVDD		89	FL_DAT3	I/O	DVDD_HV	
					90	FL_CLK	O		
91	FL_DAT0	I/O							
97	USB_DM	I/O							
98	USB_DP	I/O							
59	PCO	O	AVDD		100	REXTI	I	DVDD_HV	
60	FCO	O							
124	XIN_32K	I	DVDD_HV		125	XOUT_32K	O		
66	JTAG_TDO	O			DVDD_HV		127	XIN_PLL	I
67	JTAG_TCK	I	DVDD_HV		128	XOUT_PLL	O		
68	JTAG_TMS	I							
69	JTAG_TDI	I							
70	JTAG_TRST	I							
126	TMODE	I							

Figure 7. I/O equivalence circuits 2

Operational Notes1

1. **About Compatibility in USB Memory Device and SD Memory Card**
According to the file structure and communication speed of USB memory, SD memory card, this LSI might not play back correctly.
2. **About Compatibility in Bluetooth device**
According to the type of Bluetooth device, , this LSI might not play back correctly.
3. **About 2X Speed Recording**
Recording to a memory with slow access speed may require data connection operation.
2X speed recording to all the memories cannot be guaranteed.
4. **Power OFF or Memory Disconnection Under Memory Writing**
The sudden power off or memory disconnection during recording or file write operation to a memory may break the data in a memory.
5. **Browsing Operation**
With a memory with slow access speed, browsing operation during music playing may generate skipping.
6. **CD-ROM Playing**
CD-ROM playing operation is premised on data being inputted so that an internal data buffer may not become empty.
When an input does not meet the deadline and internal data buffers become empty, skipping occurs.
7. **Playing Time of MP3 File**
The playing time when MP3 file playing may shift when fast forward playing, rewind playing, and VBR playing.
8. **Write-In Operation Exceeding Memory Size**
Writing to a file when memory size is exceeded is not supported.
9. **Write-In Operation of the File Size Exceeding FAT Specification**
Writing to a file when file size is exceeded is not supported.
10. **About I2C Format I/F**
Although this LSI has adopted the I2C format, the level shifter circuit is not built in.
For this reason, level shifter is needed for connection with the device besides the range of operating power supply voltage of this LSI.
11. **CD Media Playing**
According to the condition of CD media, flawed, dirty, curved, eccentric and etc., this LSI might not play back normally.
12. **Application Block Diagram**
Each software function of Audio Encoder, Audio Decoder, BT stack A2DP, SBC Decoder and File System(FTA12/16/32, ISO9660) described in Figure 1. Application Block are realized by downloading applicable program from external Serial Flash ROM.

Operational Notes2

1. **Reverse Connection of Power Supply**
Connecting the power supply in reverse polarity can damage the IC. Take precautions against reverse polarity when connecting the power supply, such as mounting an external diode between the power supply and the IC's power supply pins.
2. **Power Supply Lines**
Design the PCB layout pattern to provide low impedance supply lines. Separate the ground and supply lines of the digital and analog blocks to prevent noise in the ground and supply lines of the digital block from affecting the analog block. Furthermore, connect a capacitor to ground at all power supply pins. Consider the effect of temperature and aging on the capacitance value when using electrolytic capacitors.
3. **Ground Voltage**
Ensure that no pins are at a voltage below that of the ground pin at any time, even during transient condition.
4. **Ground Wiring Pattern**
When using both small-signal and large-current ground traces, the two ground traces should be routed separately but connected to a single ground at the reference point of the application board to avoid fluctuations in the small-signal ground caused by large currents. Also ensure that the ground traces of external components do not cause variations on the ground voltage. The ground lines must be as short and thick as possible to reduce line impedance.
5. **Thermal Consideration**
Should by any chance the maximum junction temperature rating be exceeded the rise in temperature of the chip may result in deterioration of the properties of the chip. In case of exceeding this absolute maximum rating, increase the board size and copper area to prevent exceeding the maximum junction temperature rating.
6. **Recommended Operating Conditions**
These conditions represent a range within which the expected characteristics of the IC can be approximately obtained. The electrical characteristics are guaranteed under the conditions of each parameter.
7. **Inrush Current**
When power is first supplied to the IC, it is possible that the internal logic may be unstable and inrush current may flow instantaneously due to the internal powering sequence and delays, especially if the IC has more than one power supply. Therefore, give special consideration to power coupling capacitance, power wiring, width of ground wiring, and routing of connections.
8. **Operation Under Strong Electromagnetic Field**
Operating the IC in the presence of a strong electromagnetic field may cause the IC to malfunction.

Operational Notes2 – continued

9. **Testing on Application Boards**
When testing the IC on an application board, connecting a capacitor directly to a low-impedance output pin may subject the IC to stress. Always discharge capacitors completely after each process or step. The IC's power supply should always be turned off completely before connecting or removing it from the test setup during the inspection process. To prevent damage from static discharge, ground the IC during assembly and use similar precautions during transport and storage.
10. **Inter-pin Short and Mounting Errors**
Ensure that the direction and position are correct when mounting the IC on the PCB. Incorrect mounting may result in damaging the IC. Avoid nearby pins being shorted to each other especially to ground, power supply and output pin. Inter-pin shorts could be due to many reasons such as metal particles, water droplets (in very humid environment) and unintentional solder bridge deposited in between pins during assembly to name a few.
11. **Unused Input Pins**
Input pins of an IC are often connected to the gate of a MOS transistor. The gate has extremely high impedance and extremely low capacitance. If left unconnected, the electric field from the outside can easily charge it. The small charge acquired in this way is enough to produce a significant effect on the conduction through the transistor and cause unexpected operation of the IC. So unless otherwise specified, unused input pins should be connected to the power supply or ground line.
12. **Regarding the Input Pin of the IC**
In the construction of this IC, P-N junctions are inevitably formed creating parasitic diodes or transistors. The operation of these parasitic elements can result in mutual interference among circuits, operational faults, or physical damage. Therefore, conditions which cause these parasitic elements to operate, such as applying a voltage to an input pin lower than the ground voltage should be avoided. Furthermore, do not apply a voltage to the input pins when no power supply voltage is applied to the IC. Even if the power supply voltage is applied, make sure that the input pins have voltages within the values specified in the electrical characteristics of this IC.
13. **Ceramic Capacitor**
When using a ceramic capacitor, determine the dielectric constant considering the change of capacitance with temperature and the decrease in nominal capacitance due to DC bias and others.

Ordering Information

B M 9 4 8 0 3 A E K U - Z

Part Number

Package
HTQFP128UA, supply with tray

Marking Diagram

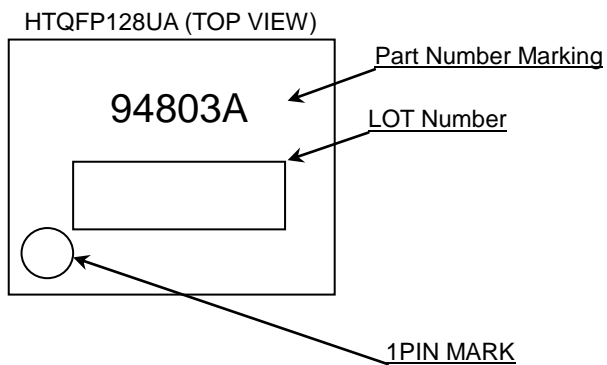

Physical Dimension, Tape and Reel Information

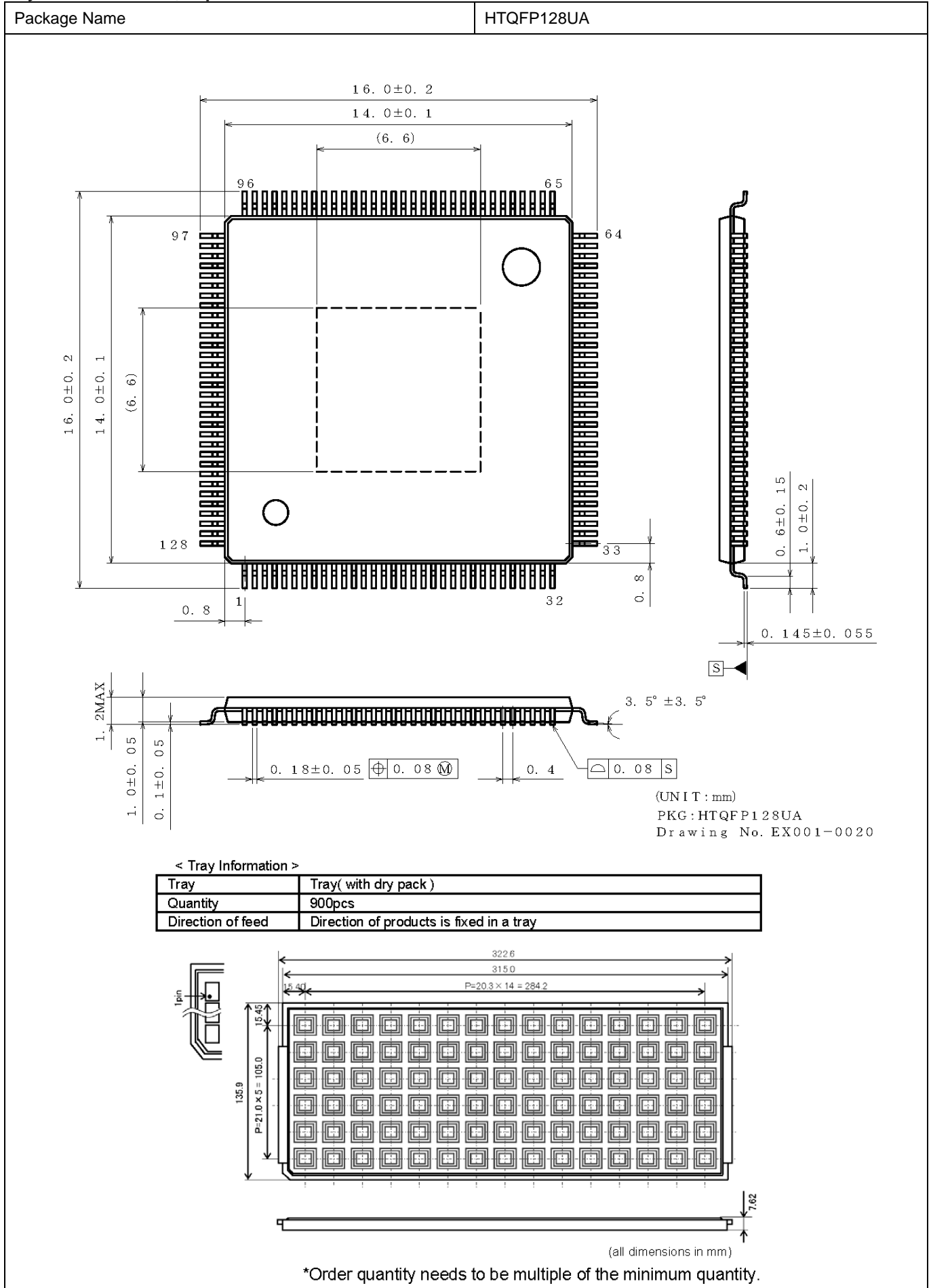

Revision History

Date	Revision	Changes
30.Aug.2016	001	New Release
25.Jan.2017	002	P10: Modified Block name of 118/119pin to I2C. P11: Modified pin name of Serial Flash ROM from SCLK to SIO3. P14: Modified pin name FLAG1 to GPIO1_7, FLAG2 to GPIO1_8, VC to VBIAS, and removed ASY_TEST, APCREF in Electrical Characteristics. P18: Added Note about Application Block diagram.

Notice

Precaution on using ROHM Products

- Our Products are designed and manufactured for application in ordinary electronic equipments (such as AV equipment, OA equipment, telecommunication equipment, home electronic appliances, amusement equipment, etc.). If you intend to use our Products in devices requiring extremely high reliability (such as medical equipment ^(Note 1), transport equipment, traffic equipment, aircraft/spacecraft, nuclear power controllers, fuel controllers, car equipment including car accessories, safety devices, etc.) and whose malfunction or failure may cause loss of human life, bodily injury or serious damage to property ("Specific Applications"), please consult with the ROHM sales representative in advance. Unless otherwise agreed in writing by ROHM in advance, ROHM shall not be in any way responsible or liable for any damages, expenses or losses incurred by you or third parties arising from the use of any ROHM's Products for Specific Applications.

(Note1) Medical Equipment Classification of the Specific Applications

JAPAN	USA	EU	CHINA
CLASS III	CLASS III	CLASS II b	CLASS III
CLASS IV		CLASS III	

- ROHM designs and manufactures its Products subject to strict quality control system. However, semiconductor products can fail or malfunction at a certain rate. Please be sure to implement, at your own responsibilities, adequate safety measures including but not limited to fail-safe design against the physical injury, damage to any property, which a failure or malfunction of our Products may cause. The following are examples of safety measures:
 - Installation of protection circuits or other protective devices to improve system safety
 - Installation of redundant circuits to reduce the impact of single or multiple circuit failure
- Our Products are designed and manufactured for use under standard conditions and not under any special or extraordinary environments or conditions, as exemplified below. Accordingly, ROHM shall not be in any way responsible or liable for any damages, expenses or losses arising from the use of any ROHM's Products under any special or extraordinary environments or conditions. If you intend to use our Products under any special or extraordinary environments or conditions (as exemplified below), your independent verification and confirmation of product performance, reliability, etc. prior to use, must be necessary:
 - Use of our Products in any types of liquid, including water, oils, chemicals, and organic solvents
 - Use of our Products outdoors or in places where the Products are exposed to direct sunlight or dust
 - Use of our Products in places where the Products are exposed to sea wind or corrosive gases, including Cl₂, H₂S, NH₃, SO₂, and NO₂
 - Use of our Products in places where the Products are exposed to static electricity or electromagnetic waves
 - Use of our Products in proximity to heat-producing components, plastic cords, or other flammable items
 - Sealing or coating our Products with resin or other coating materials
 - Use of our Products without cleaning residue of flux (even if you use no-clean type fluxes, cleaning residue of flux is recommended); or Washing our Products by using water or water-soluble cleaning agents for cleaning residue after soldering
 - Use of the Products in places subject to dew condensation
- The Products are not subject to radiation-proof design.
- Please verify and confirm characteristics of the final or mounted products in using the Products.
- In particular, if a transient load (a large amount of load applied in a short period of time, such as pulse. is applied, confirmation of performance characteristics after on-board mounting is strongly recommended. Avoid applying power exceeding normal rated power; exceeding the power rating under steady-state loading condition may negatively affect product performance and reliability.
- De-rate Power Dissipation depending on ambient temperature. When used in sealed area, confirm that it is the use in the range that does not exceed the maximum junction temperature.
- Confirm that operation temperature is within the specified range described in the product specification.
- ROHM shall not be in any way responsible or liable for failure induced under deviant condition from what is defined in this document.

Precaution for Mounting / Circuit board design

- When a highly active halogenous (chlorine, bromine, etc.) flux is used, the residue of flux may negatively affect product performance and reliability.
- In principle, the reflow soldering method must be used on a surface-mount products, the flow soldering method must be used on a through hole mount products. If the flow soldering method is preferred on a surface-mount products, please consult with the ROHM representative in advance.

For details, please refer to ROHM Mounting specification

Precautions Regarding Application Examples and External Circuits

1. If change is made to the constant of an external circuit, please allow a sufficient margin considering variations of the characteristics of the Products and external components, including transient characteristics, as well as static characteristics.
2. You agree that application notes, reference designs, and associated data and information contained in this document are presented only as guidance for Products use. Therefore, in case you use such information, you are solely responsible for it and you must exercise your own independent verification and judgment in the use of such information contained in this document. ROHM shall not be in any way responsible or liable for any damages, expenses or losses incurred by you or third parties arising from the use of such information.

Precaution for Electrostatic

This Product is electrostatic sensitive product, which may be damaged due to electrostatic discharge. Please take proper caution in your manufacturing process and storage so that voltage exceeding the Products maximum rating will not be applied to Products. Please take special care under dry condition (e.g. Grounding of human body / equipment / solder iron, isolation from charged objects, setting of Ionizer, friction prevention and temperature / humidity control).

Precaution for Storage / Transportation

1. Product performance and soldered connections may deteriorate if the Products are stored in the places where:
 - [a] the Products are exposed to sea winds or corrosive gases, including Cl₂, H₂S, NH₃, SO₂, and NO₂
 - [b] the temperature or humidity exceeds those recommended by ROHM
 - [c] the Products are exposed to direct sunshine or condensation
 - [d] the Products are exposed to high Electrostatic
2. Even under ROHM recommended storage condition, solderability of products out of recommended storage time period may be degraded. It is strongly recommended to confirm solderability before using Products of which storage time is exceeding the recommended storage time period.
3. Store / transport cartons in the correct direction, which is indicated on a carton with a symbol. Otherwise bent leads may occur due to excessive stress applied when dropping of a carton.
4. Use Products within the specified time after opening a humidity barrier bag. Baking is required before using Products of which storage time is exceeding the recommended storage time period.

Precaution for Product Label

A two-dimensional barcode printed on ROHM Products label is for ROHM's internal use only.

Precaution for Disposition

When disposing Products please dispose them properly using an authorized industry waste company.

Precaution for Foreign Exchange and Foreign Trade act

Since concerned goods might be fallen under listed items of export control prescribed by Foreign exchange and Foreign trade act, please consult with ROHM in case of export.

Precaution Regarding Intellectual Property Rights

1. All information and data including but not limited to application example contained in this document is for reference only. ROHM does not warrant that foregoing information or data will not infringe any intellectual property rights or any other rights of any third party regarding such information or data.
2. ROHM shall not have any obligations where the claims, actions or demands arising from the combination of the Products with other articles such as components, circuits, systems or external equipment (including software).
3. No license, expressly or implied, is granted hereby under any intellectual property rights or other rights of ROHM or any third parties with respect to the Products or the information contained in this document. Provided, however, that ROHM will not assert its intellectual property rights or other rights against you or your customers to the extent necessary to manufacture or sell products containing the Products, subject to the terms and conditions herein.

Other Precaution

1. This document may not be reprinted or reproduced, in whole or in part, without prior written consent of ROHM.
2. The Products may not be disassembled, converted, modified, reproduced or otherwise changed without prior written consent of ROHM.
3. In no event shall you use in any way whatsoever the Products and the related technical information contained in the Products or this document for any military purposes, including but not limited to, the development of mass-destruction weapons.
4. The proper names of companies or products described in this document are trademarks or registered trademarks of ROHM, its affiliated companies or third parties.

General Precaution

1. Before you use our Products, you are requested to carefully read this document and fully understand its contents. ROHM shall not be in any way responsible or liable for failure, malfunction or accident arising from the use of any ROHM's Products against warning, caution or note contained in this document.
2. All information contained in this document is current as of the issuing date and subject to change without any prior notice. Before purchasing or using ROHM's Products, please confirm the latest information with a ROHM sales representative.
3. The information contained in this document is provided on an "as is" basis and ROHM does not warrant that all information contained in this document is accurate and/or error-free. ROHM shall not be in any way responsible or liable for any damages, expenses or losses incurred by you or third parties resulting from inaccuracy or errors of or concerning such information.



BM94803AEKU - Web Page

[Distribution Inventory](#)

Part Number	BM94803AEKU
Package	HTQFP128UA
Unit Quantity	900
Minimum Package Quantity	900
Packing Type	Tray
Constitution Materials List	inquiry
RoHS	Yes