

# MAX14724PMB1 Peripheral Module

Evaluates: MAX14724

## General Description

The MAX14724PMB1 peripheral module provides the necessary hardware to interface the MAX14724 8:4 matrix switch multiplexer to any system that utilizes Pmod™-compatible expansion ports configurable for I<sup>2</sup>C or SPI communication. The IC can be powered from a single 1.6V to 5.5V supply or dual ±2.5V supplies. The device features an 8:4 multiplexer that every switch combination can be selected through using I<sup>2</sup>C or SPI. Refer to the MAX14724 IC data sheet for detailed information regarding the operation of the IC.

## Features

- 8:4 Matrix Switch Multiplexer
- 50Ω Controlled-Impedance Signal Traces
- 12-Pin Pmod-Compatible Connector
- Proven PCB Layout
- Fully Assembled and Tested

## EV Kit Contents

- Peripheral module containing a MAX14724

Ordering Information appears at end of data sheet.

## MAX14724PMB1 Evaluation Kit Board

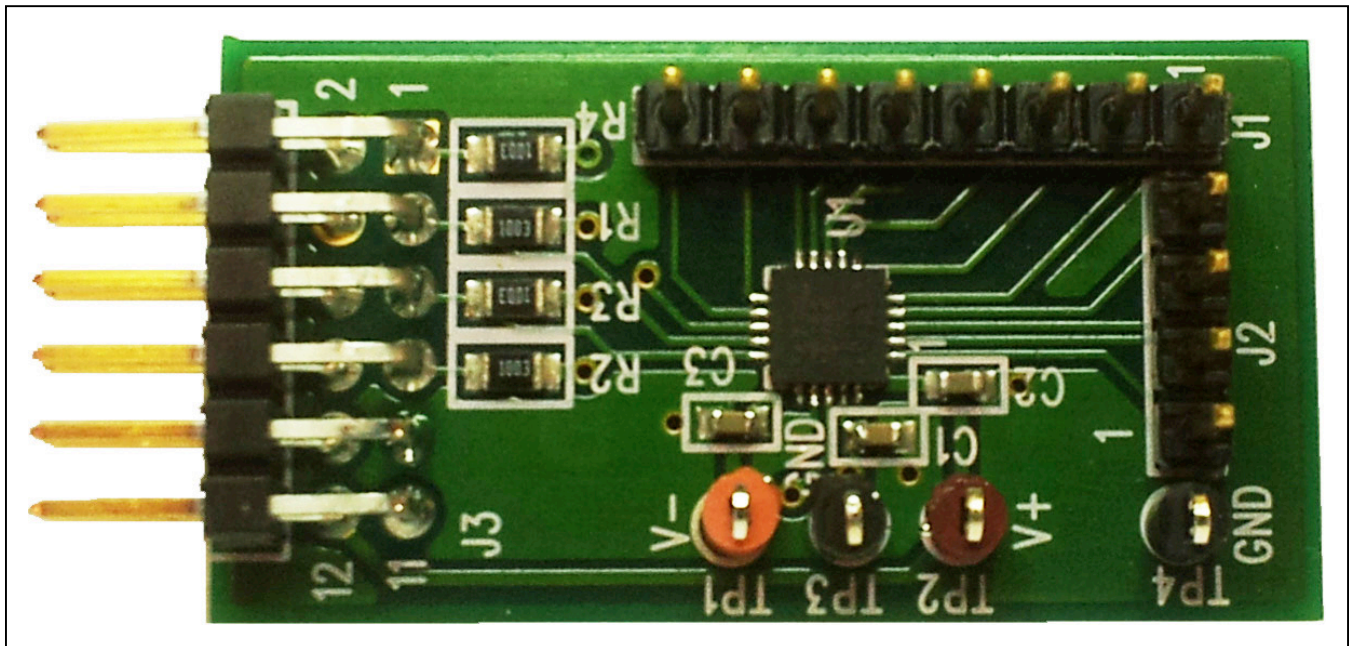

*Pmod is a trademark of Digilent Inc.*

# MAX14724PMB1 Peripheral Module

Evaluates: MAX14724

## Detailed Description

The MAX14724PMB1 peripheral module provides a convenient way to evaluate the MAX14724 multiplexer. All PCB signal traces are 50Ω controlled impedance to allow

easy impedance matching. The device can be programmed by using I<sup>2</sup>C or SPI.

The J1 connector provides connection to NO\_ ports (see [Table 1](#)), while the J2 connector provides connection to COM\_ ports (see [Table 2](#)).

The MAX14724PMB1 can interface to the host by plugging directly into a Pmod-compatible port (configured for I<sup>2</sup>C or SPI) through connector J3 (see [Table 3](#)).

**Table 1. Connector J1**

PIN	SIGNAL
1	NO1
2	NO2
3	NO3
4	NO4
5	NO5
6	NO6
7	NO7
8	NO8

**Table 2. Connector J2**

PIN	SIGNAL
1	COMD
2	COMC
3	COMB
4	COMA

**Table 3. Connector J3**

PIN	Pmod PIN	SIGNAL		DESCRIPTION
		I <sup>2</sup> C/ $\overline{CS}$ = 1	I <sup>2</sup> C/ $\overline{CS}$ = 0	
1	1	I <sup>2</sup> C/ $\overline{CS}$	I <sup>2</sup> C/ $\overline{CS}$	I <sup>2</sup> C select (high)/SPI $\overline{CS}$ (low)
2	7	N.C.	N.C.	Not connected
3	2	SDA	DI	I <sup>2</sup> C serial data/SPI data input
4	8	N.C.	N.C.	Not connected
5	3	ADD	DO	I <sup>2</sup> C address bit/SPI data output
6	9	N.C.	N.C.	Not connected
7	4	SCL	SCK	I <sup>2</sup> C serial clock/SPI serial clock
8	10	N.C.	N.C.	Not connected
9	5	GND	GND	Ground
10	11	V-	V-	Negative supply voltage
11	6	V <sub>L</sub>	V <sub>L</sub>	Logic supply voltage
12	12	V+	V+	Positive supply voltage

**Table 4. I<sup>2</sup>C Slave Address Configuration**

LOGIC INPUT	I <sup>2</sup> C SLAVE ADDRESS									
ADD/DO	A6	A5	A4	A3	A2	A1	A0 (ADD)	R/ $\overline{W}$	READ	WRITE
0	1	1	1	0	1	0	0	1/0	0xE9	0xE8
1	1	1	1	0	1	0	1	1/0	0xEB	0xEA

---

# MAX14724PMB1

## Peripheral Module

Evaluates: MAX14724

### Component Information

See the following links for component information, PCB files, and schematics:

- [MAX14724 EV BOM](#)
- [MAX14724 EV PCB](#)
- [MAX14724 EV Schematic](#)

### Ordering Information

PART	TYPE
MAX14724PMB1#	Peripheral Module

#Denotes RoHS compliant.

### Revision History

REVISION NUMBER	REVISION DATE	DESCRIPTION	PAGES CHANGED
0	5/15	Initial release	—

For pricing, delivery, and ordering information, please contact Maxim Direct at 1-888-629-4642, or visit Maxim Integrated's website at [www.maximintegrated.com](http://www.maximintegrated.com).

*Maxim Integrated cannot assume responsibility for use of any circuitry other than circuitry entirely embodied in a Maxim Integrated product. No circuit patent licenses are implied. Maxim Integrated reserves the right to change the circuitry and specifications without notice at any time.*

5

4

3

2

1



TITLE: **MAX14724\_PMB1\_EVKIT**      REV: **A**

DRAWN:      DATED: **APRIL 2015**

PCB PART NUMBER:      SHEET: 1 OF 1

APPROVAL      DATED:

REVISION:      DATED:

REVISION:      DATED:

REVISION:      DATED:

REVISION:      DATED:

REVISION:      DATED:

REVISION:      DATED:

D

C

B

A

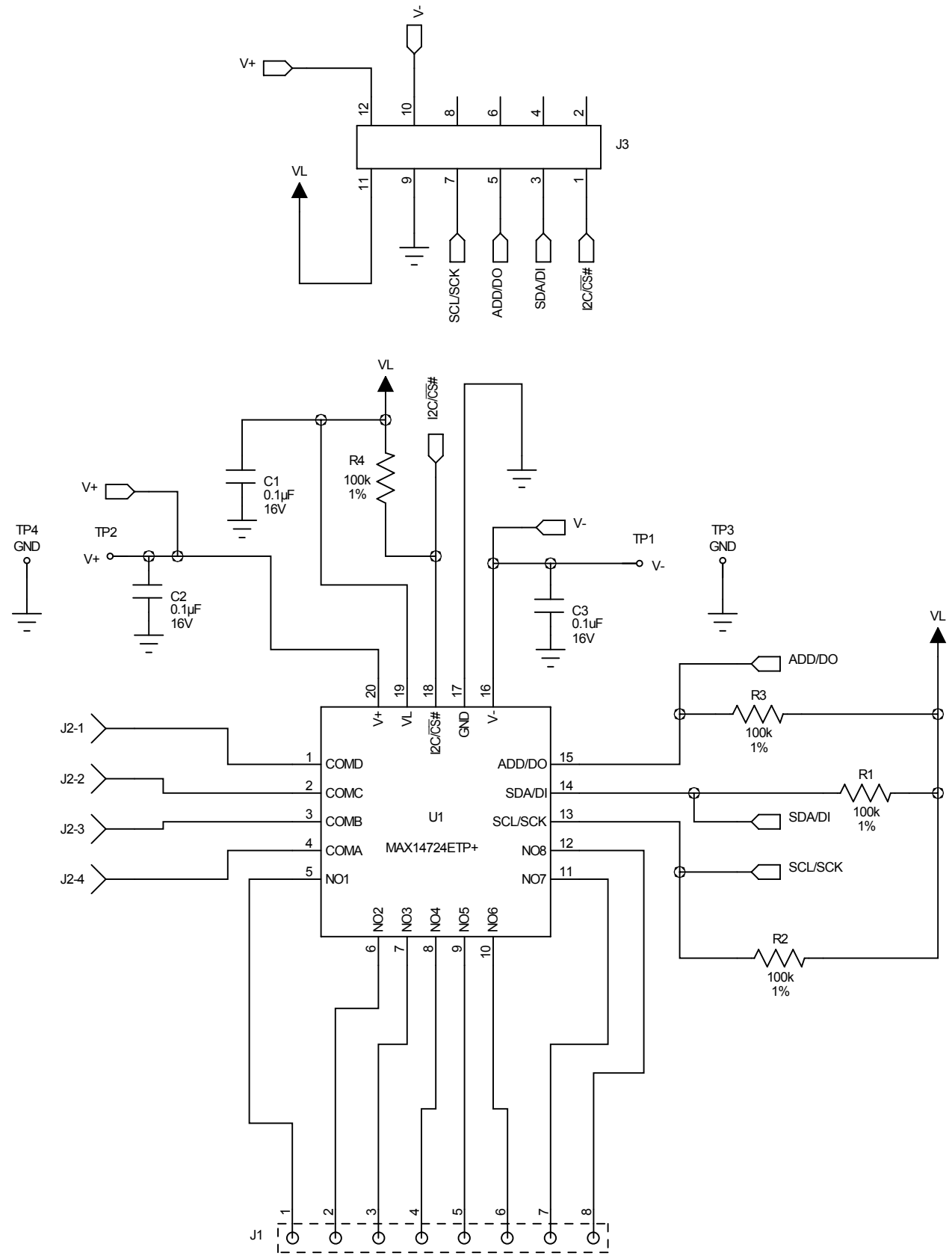

MAX14724_PMB1_EVKIT	
	REV A
 <b>maxim integrated™</b>	
LAYER	TOP SILKSCREEN
DATE:	ALL UNITS ARE IN 0.001"

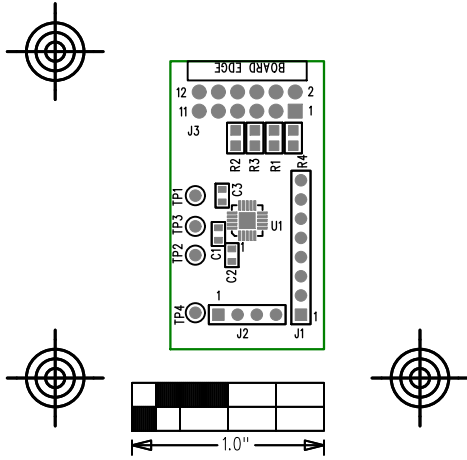

MAX14724_PMB1_EVKIT	
	REV A
 <b>maxim integrated™</b>	
LAYER	COMPONENT SIDE
DATE:	ALL UNITS ARE IN 0.001"

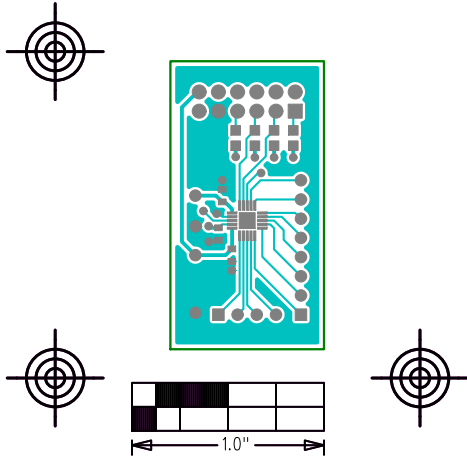

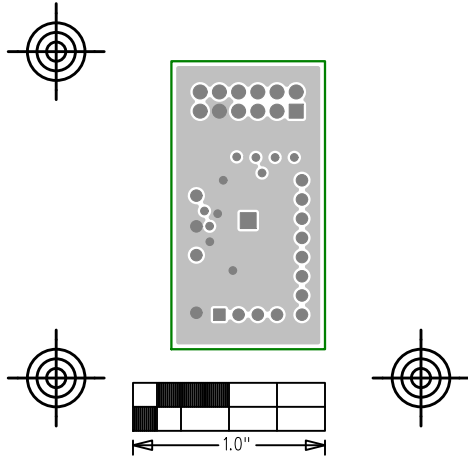

MAX14724_PMB1_EVKIT	
	REV A
 <b>maxim integrated™</b>	
LAYER	LAYER 2 GND
DATE:	ALL UNITS ARE IN 0.001"





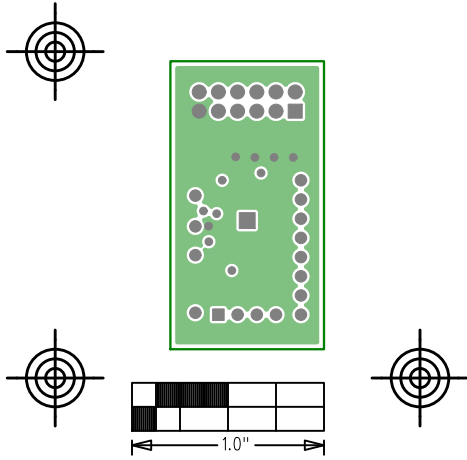

MAX14724_PMB1_EVKIT	
	REV A
 <b>maxim integrated™</b>	
LAYER	LAYER 3 PWR
DATE:	ALL UNITS ARE IN 0.001"

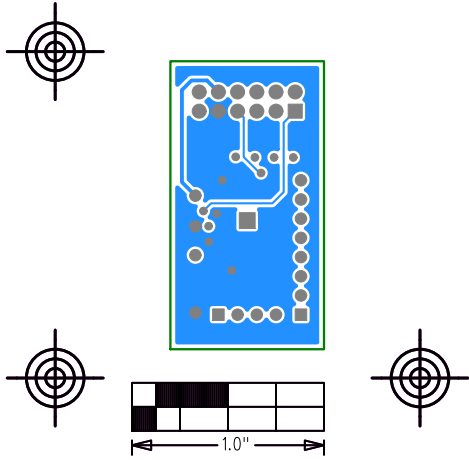

MAX14724_PMB1_EVKIT	
	REV A
 <b>maxim integrated™</b>	
LAYER	SOLDER SIDE
DATE:	ALL UNITS ARE IN 0.001"



MAX14724_PMB1_EVKIT	
	REV A
 <b>maxim integrated™</b>	
LAYER	BOTTOM SILKSCREEN
DATE:	ALL UNITS ARE IN 0.001"

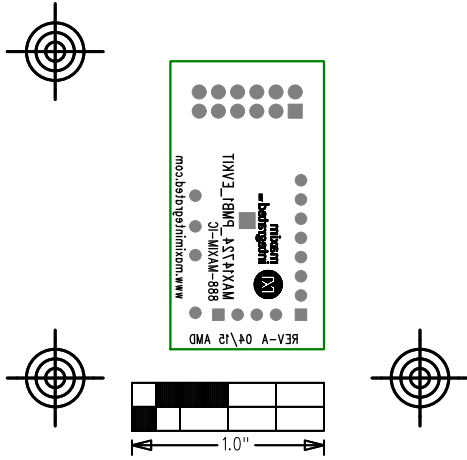

## Bill of Materials (BOM)

Part Reference	Qty	Description
C1,C2,C3	3	CAPACITOR CER 0.1UF 16V ±10% X7R 0603
J1	1	8 PIN STRAIGHT MALE HEADER
J2	1	4 PIN STRAIGHT MALE HEADER
J3	1	12 PIN RIGHT ANGLE MALE HEADER
R1,R2,R3,R4	4	RES 100K OHM 1% 0805 SMD
TP1	1	ORANGE TEST POINT
TP2	1	RED TEST POINT
TP3,TP4	2	BLACK TEST POINT
		IC 8:4 MATRIX SWITCH MULTIPLEXER
U1	1	(MAX14724ETP+)
	1	PCB: EPCB14724